

Plastic bodied limit switch Series BI2

Description **BI2-U1Z AH**

Article number **6185135106**

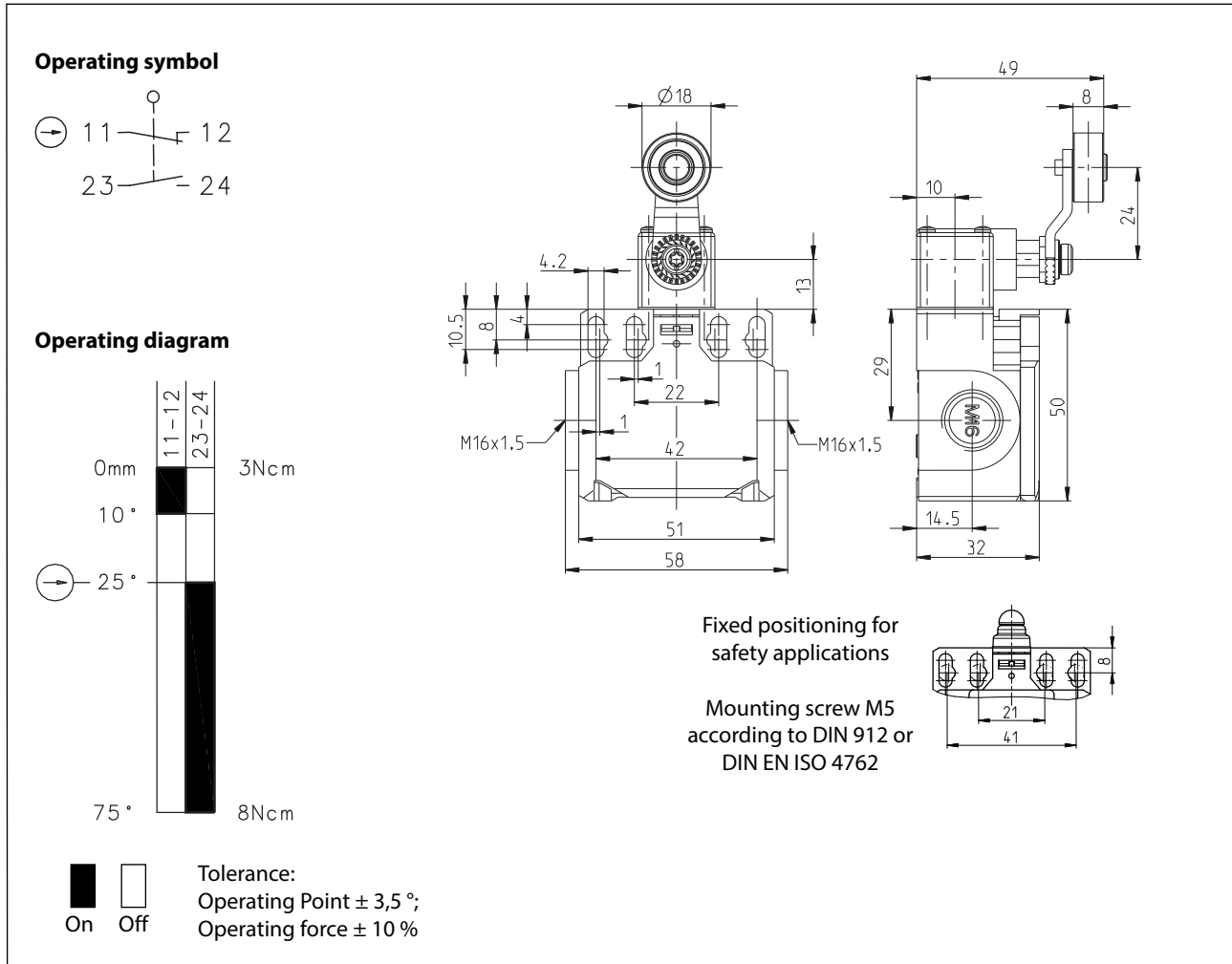

Electrical Data

Rated insulation voltage	U_i	400 V AC
Conv. thermal current	I_{the}	10 A
Rated operational voltage	U_e	240 V AC
Utilization category		AC-15, U_e / I_e 240 V / 3 A
Direct opening action	\ominus	acc. to IEC/EN 60947-5-1, annex K
Short-circuit protective device		Fuse 10 A gG
Protection class		II, totally insulated

Mechanical data	
Enclosure	Thermoplastic, glass fibre reinforced
Cover	Thermoplastic, glass fibre reinforced
Actuator	Lever arm housing, roller (thermoplastic)
Ambient air temperature	-30° C ... +80° C
Contact type	1 NC, 1 NO (Zb)
Mechanical life	10 x 10 ⁶ operating cycles
Switching frequency	≤ 100 / min.
Assembly	2 x M4 / 2 x M5 / 2 x M3 front mounting
Connection	4 screw connections (M3,5)
Conductor cross-sections	Solid: 0,5 ... 1,5 mm ² or Litz wire with ferrules: 0,5 ... 1,5 mm ²
Cable entrance	2 x M16 x 1,5
Weight	≈ 0,12 kg
Installation position	operator definable
Protection type	IP65 acc. to IEC/EN 60529

ID for safety engineering	
B10d	20 x 10 ⁶ cycles

Actuation
<p>The actuating device is preferably started from 2 sides. By loosening the 4 screws the actuation assembly can be rotated in 90 degree increments such that 8 actuation directions are possible. The actuation assembly is to be again fastened to the housing using the 4 screws.</p>

Standards
VDE 0660 T100, DIN EN 60947-1, IEC 60947-1
VDE 0660 T200, DIN EN 60947-5-1, IEC 60947-5-1
DIN EN ISO 13849-1

EU Conformity
acc. to directive 2014/35/EU

Approvals
cCSA _{US} A300, Q300
CCC

Notes
The degree of protection (IP code) specified applies solely to a property closed cover and the use of an equivalent cable gland with adequate cable.