

# Thermo Scientific Orion AQUAfast AQ4000 Colorimeter

User Guide

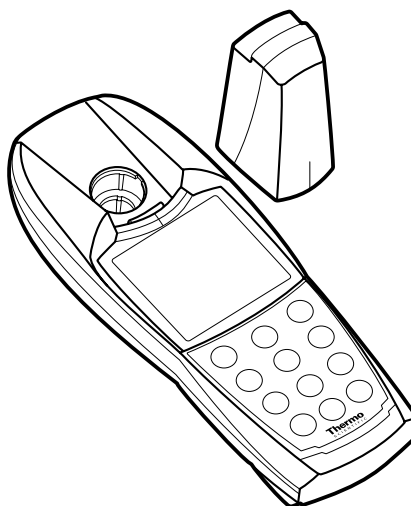

ROSS and the COIL trade dress are trademarks of Thermo Fisher Scientific Inc. US patent 6,793,787.

AQUAfast, Cahn, ionplus, KNIPHE, No Cal, ORION, perpHect, PerpHecT, PerpHecTion, pHISA, pHuture, Pure Water, Sage, Sensing the Future, SensorLink, ROSS, ROSS Ultra, Sure-Flow, Titrator PLUS and TURBO2 are registered trademarks of Thermo Fisher.

1-888-pHAX-ION, A+, All in One, Aplus, AQUAsnap, AssuredAccuracy, AUTO-BAR, AUTO-CAL, AUTO DISPENSER, Auto-ID, AUTO-LOG, AUTO-READ, AUTO-STIR, Auto-Test, BOD AutoEZ, Cable-Free, CERTI-CAL, CISA, DataCOLLECT, DataPLUS, digital LogR, DirectCal, DuraProbe, Environmental Product Authority, Extra Easy/Extra Value, FAST QC, GAP, GLPcal, GLPcheck, GLPdoc, ISEasy, KAP, LabConnect, LogR, Low Maintenance Triode, Minimum Stir Requirement, MSR, NISS, One-Touch, One-Touch Calibration, One-Touch Measurement, Optimum Results, Orion Star, Pentrode, pHuture MMS, pHuture Pentrode, pHuture Quatrode, pHuture Triode, Quatrode, QuiKcheK, rf link, ROSS Resolution, SAOB, SMART AVERAGING, Smart CheK, SMART STABILITY, Stacked, Star Navigator 21, Stat Face, The Enhanced Lab, ThermaSense, Triode, TRIUMpH, Unbreakable pH, Universal Access are trademarks of Thermo Fisher.

Guaranteed Success and The Technical Edge are service marks of Thermo Fisher.

PerpHecT meters are protected by U.S. patent 6,168,707.

PerpHecT ROSS electrodes are protected by U.S. patent 6,168,707.

ORION Series A meters and 900A printer are protected by U.S. patents 5,198,093, D334,208 and D346,753.

ionplus electrodes and Optimum Results solutions are protected by US patent 5,830,338.

ROSS Ultra electrodes are protected by US patent 6,793,787.

ORP standard is protected by US patent 6,350,367.

No Cal electrodes are protected by US patent 7,276,142.

© 2009 Thermo Fisher Scientific Inc. All rights reserved. All trademarks are the property of Thermo Fisher Scientific Inc. and its subsidiaries.

The specifications, descriptions, drawings, ordering information and part numbers within this document are subject to change without notice.

This publication supersedes all previous publications on this subject.

# Table of Contents

<b>Chapter 1</b>	<b>Introduction</b> .....	<b>1</b>
	Display .....	2
	Keypad .....	3
<b>Chapter 2</b>	<b>Instrument Setup</b> .....	<b>5</b>
	Battery Installation .....	5
	Cuvette Cover .....	6
	Cuvette Adapters .....	7
	RS232 Connection .....	8
<b>Chapter 3</b>	<b>Setup Menu</b> .....	<b>9</b>
	Setup Functions .....	9
	Blank .....	10
	Verify .....	11
	Digits .....	13
	Clock .....	13
	Set Baud .....	14
	Print .....	14
	Auto Print .....	15
	Self Test .....	15
	Methods Update .....	16
<b>Chapter 4</b>	<b>User Programs</b> .....	<b>17</b>
	Custom User Programs .....	17
	Enter a User Program .....	17
	Calibrate a User Program .....	19
<b>Chapter 5</b>	<b>Measurement</b> .....	<b>21</b>
	Zero Procedure .....	21
	Zero with an Auto-Test Cuvette .....	22
	Zero with a Standard Cuvette .....	22
	Sample Measurement .....	23
	Measurement with an Auto-Test Sample Cuvette .....	23
	Measurement with a Standard Cuvette and Reagent .....	24

<b>Chapter 6</b>	<b>Log and Interface Functions</b> .....	<b>25</b>
	Log Function .....	25
	Log Data .....	25
	Display the Log .....	25
	Clear the Log .....	25
	Print or Download to the Log .....	25
	Interfacing with Printers and Computers .....	26
	Data Transmission Settings .....	26
<b>Chapter 7</b>	<b>Customer Services</b> .....	<b>27</b>
	Colorimeter Self Test .....	27
	Operator Assistance Codes .....	27
	Maintenance .....	27
	Assistance .....	28
	Warranty .....	28
	Declaration of Conformity .....	28
	List of Program Numbers .....	29
	Method Instruction Sheets .....	30
	Ordering Information .....	31
	Specifications .....	34

# Chapter 1 Introduction

The Thermo Scientific Orion AQ4000 AQUAfast IV colorimeter is the most advanced portable microprocessor-based, LED colorimeter on the market today. It can be used for most common colorimetric measurements.\* The colorimeter features the exclusive Auto-ID test recognition capability that automatically recognizes the test and initiates measurement. Coupled with our Auto-Test, colorimetric testing has never been easier. Auto-Test cuvettes are pre-measured, self-filling tests designed for many of the common water quality measurements.

The AQUAfast IV features pre-programmed methods as well as a custom calibration procedure. A simple user interface steps the user through setup and custom methods. The instrument will log 100 data points and download them to a printer or computer. The AQ4000 will never become obsolete because new methods can be easily downloaded to the unit.

\* Now available for use on the AQ4000 are powder chemistry packs. The powder chemistry packs allow for easier and cleaner measurements. A large majority of AQUAfast II tablet chemistries can be used on the AQ4000 as well. The AQ4000 is also capable of measuring for COD.

# Display

**Figure 1**  
AQ4000 Display

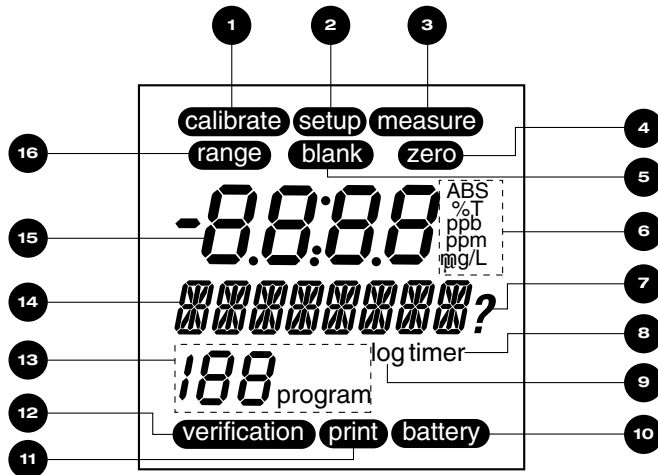







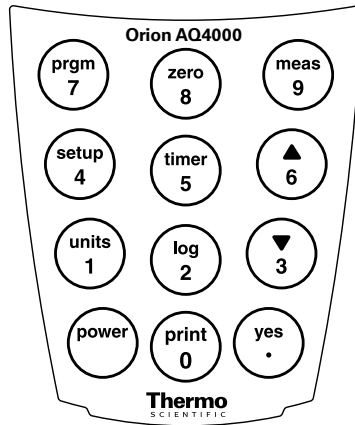





Item	Description
1 Calibrate	Icon lit while AQ4000 is in calibration mode
2 Setup	Icon lit while AQ4000 is in setup mode
3 Measure	Icon lit during measurement
4 Zero	Icon lit while AQ4000 performs zero
5 Blank	Icon lit when a blank is active for selected method
6 Units	Icons for units of measurement
7 ?	Icon lit when AQ4000 prompts a question
8 Timer	Icon lit while timer is active
9 Log	Icon lit if data is in AQ4000 log
10 Battery	Icon lit when battery in AQ4000 is low
11 Print	Icon lit during print function
12 Verification	Icon lit while AQ4000 is in method verification mode
13 188 program	Icon for active program number
14	Alphanumeric display
15	Numeric display
16 Range	Icon lit to indicate over range condition

# Keypad

**Figure 2**  
AQ4000 Keypad



Key	Description
	Turns the AQ4000 on or off
	Initiates print mode or inputs number 0
	Confirms an answer or places the decimal point
	Allows selection of measurement units – mg/L, ppm, % T, absorbance or inputs number 1
	Initiates data log mode or inputs number 2
	Scrolls down or inputs number 3
	Initiates setup mode or inputs number 4
	Initiates timer, allows access to time/date and stopwatch or inputs number 5
	Scrolls up or inputs number 6
	Initiates program number or inputs number 7
	Initiates a zero measurement or inputs number 8
	Initiates a measurement or inputs number 9





## Chapter 2 Instrument Setup

### Battery Installation

The AQ4000 colorimeter requires 4 AA alkaline or lithium batteries. With 4 alkaline batteries, the expected life is 2,500 hours. With 4 lithium batteries, the expected life is 10,000 hours.

To install the batteries, carefully loosen the two captive screws on the bottom of the battery cover. Remove the cover and insert the batteries as shown in **Figure 3**.

**Figure 3**  
Battery Installation

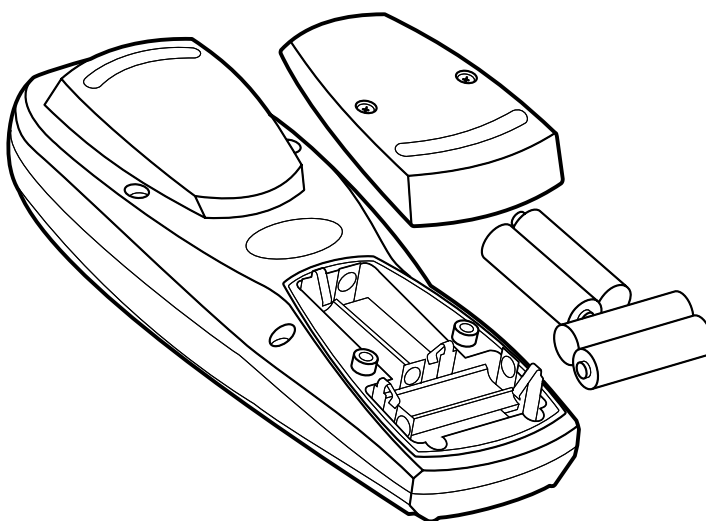

Replace the battery cover and tighten the captive screws.

## Cuvette Cover

The cuvette cover serves two functions; it keeps the optical well covered so dirt and dust do not enter the well and it covers the cuvette during measurements to prevent stray light from affecting the measurements.

**Figure 4**

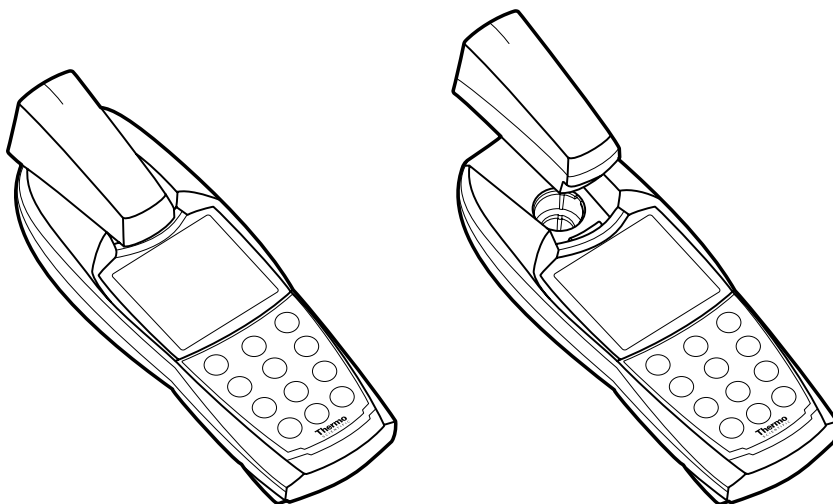

To remove the cuvette cover, lift the cover straight up as shown in **Figure 4**.

To cover a sample for measurement, carefully place the cuvette cover over the cuvette as shown in **Figure 5** and align the mark in the cover with the mark on the colorimeter.

**Figure 5**

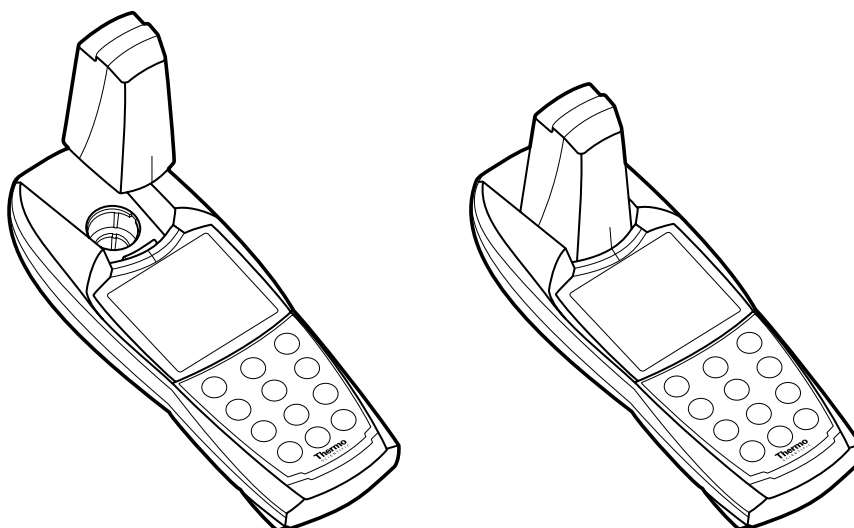

## Cuvette Adapters

The AQ4000 is shipped with two cuvette adapters. One adapter is for 13 mm Auto-Test cuvettes and the other is for 16 mm cuvettes. If using 24 mm cuvettes, no adapter is required. The adapters ensure the correct alignment of the cuvette in the well. If a cuvette is not aligned properly or the adapter is not used correctly, measurement errors may occur.

To insert the adapter, align the male tabs on the adapter with the slots in the well. Firmly push down on the adapter until it slides in place. See **Figure 6**.

**Figure 6**  
AQ4000 with the  
Cuvette Adapter

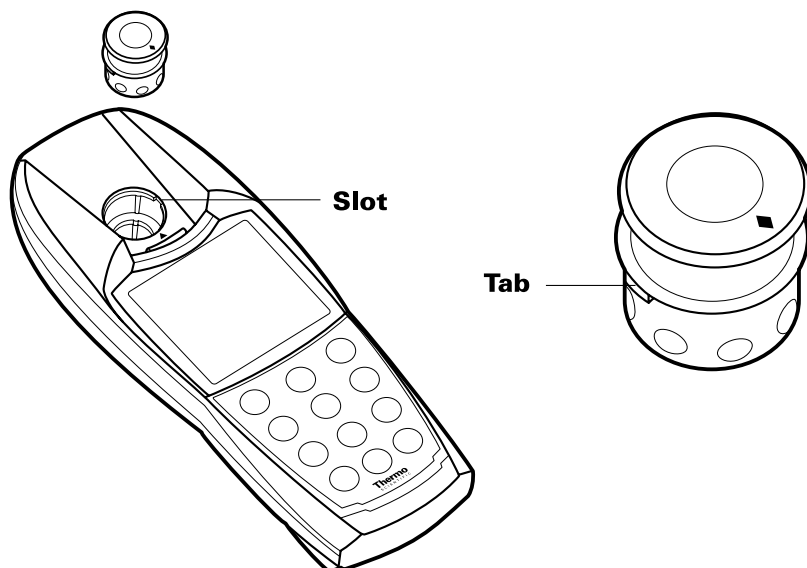

## RS232 Connection

The AQ4000 has a bidirectional RS232 port located on the underside of the colorimeter. See **Figure 7**. To connect the AQ4000 to a printer or computer, use the RS232 cable, Cat. No. AQ4CBL. See the **Interfacing with Printers and Computers** section for more information.

**Figure 7**  
AQ4000 Connection

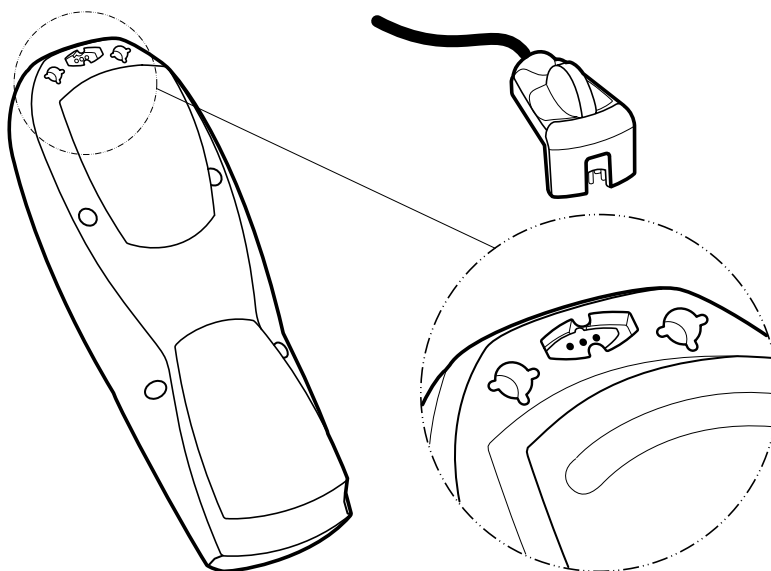

## Chapter 3 Setup Menu

### Setup Functions

The  key allows the user to access all the user selectable functions in the AQ4000 colorimeter.

There are two levels of setup menus available to the user. The first is a general setup menu used with any of the pre-programmed methods. The second is the setup menu used when selecting a custom or user program.

#### General

<b>Blank</b>	Allows the user to set a reagent blank for a particular chemistry. The blank is method specific. Blank is not visible while in programs 1 through 4.
<b>Verify</b>	Allows the user to verify the quality of the measurement by either running a standard as a sample or doing a spike recovery. Verify is not visible while in programs 1 through 4.
<b>Digits</b>	Allows the user to select the number of significant digits to be displayed.
<b>Clock</b>	Allows the user to set the date and time.
<b>Set Baud</b>	Allows the user to set the baud rate for the instrument when using it with a printer or computer.
<b>Print</b>	Allows the user to set the print out format.
<b>Auto Print</b>	Allows the user to set the colorimeter to automatically print each measurement.
<b>Self-test</b>	Allows the user to initiate a self-test to verify instrument operation.
<b>Upload</b>	Allows the user to upload current measurement technique into colorimeter.

#### User Program Only









<b>User Prgm</b>	Allows the user to enter a custom user program.
<b>Cal User</b>	Allows the user to enter a calibration curve for the custom program which they entered.

## Blank

The blank function subtracts the color absorbed when running the test with deionized water as a sample. This allows the user to compensate for any background color due to the reagent. Note that this is done for a particular test and will only subtract the blank for that particular test.









### To Set Blank



1. Press .
2. Press  or  until "BLANK" is displayed.
3. Press , "SET BLNK?" will be displayed.
4. Press , "SAMPLE?" will be displayed.
5. Wipe the Auto-Test cuvette with a soft cloth and insert the cuvette containing deionized water and reagent into the sample well and cover.
6. Press  and allow the meter to read the blank.
7. The blank value will be displayed and the meter will proceed to the next setup function.
8. To proceed to the measure mode, press  to proceed to sample measurement or  to proceed through the setup menu.

**Note:** A blank must be set for each desired test.

### To Clear Blank

1. Press .
2. Press  or  until "BLANK" is displayed.
3. Press , "SET BLNK?" will be displayed.
4. Press  or  until "CLR BLNK?" is displayed.
5. Press  to clear blank, "CLEARED" will be displayed.
6. To proceed to the measure mode, press  to proceed to sample measurement or  to proceed through the setup menu.





## Verify

The verify function allows the user to check the quality of the measurement being made. Using the direct verification, a standard in the measurement range of the test can be read as a sample. This simple test procedure ensures a user is correctly measuring samples.

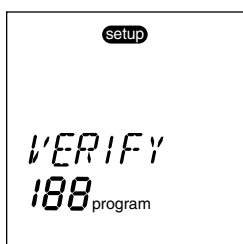
The spike recovery verification is similar to a known addition. A standard of known concentration is added to an unknown sample. The spiked sample is then read and the AQ4000 calculates the concentration of the original sample. The AQ4000 steps a user through the measurement process and allows a simple verification of method validity.









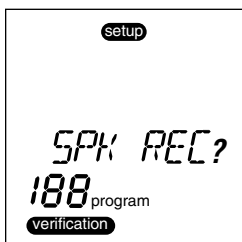

### Direct Verification



1. Press .
2. Press  or  until "VERIFY" is displayed.
3. Press , "DIRECT?" will be displayed.
4. Press , "SAMPLE?" will be displayed.
5. If using an Auto-Test cuvette, invert the Auto-Test cuvette in the standard solution to be measured and snap the tip. If using a standard type cuvette, react the standard solution with reagent as described in the reagent instructions.
6. Wipe the Auto-Test cuvette with a soft cloth and insert it into the colorimeter.
7. Insert the cuvette into the AQ4000. Align the ▼ on the Auto-Test cuvette with the ◆ on the adapter to obtain a continuous beeping and view \*\*\*\*\* across the display. If \*\*\*\*\* and beeping are not observed, rotate the cuvette right or left to initiate the measurement.
8. Cover the cuvette. When the wait time is complete, the value of the standard will be displayed.

## Spike Recovery









1. Press .
2. Press  or  until "VERIFY" is displayed.
3. Press , "DIRECT?" will be displayed.
4. Press  or  until "SPK REC?" is displayed.
5. Press , "STD CONC??" will be displayed.
6. Enter the concentration of the standard to be used for the spike and press . It is recommended to use a standard 10 to 100 times more concentrated.
7. "SAMP VOL?" will be displayed. Enter the total volume of the sample.
8. "STD VOL?" will be displayed. Enter the volume of the spike to be added. It is recommended not to add more than 10% of the original sample volume.
9. In a beaker, place the sample and by volume add the standard and mix. If using an Auto-Test cuvette, transfer the sample plus the standard to the graduated sample cup.
10. "INS VIAL" will be displayed.
11. If using an Auto-Test cuvette, invert the Auto-Test cuvette in the sample plus standard solution to be measured and snap the tip. If using a standard type cuvette, react the standard solution with reagent as described in the reagent instructions.
12. Wipe the Auto-Test cuvette with a soft cloth and insert it into the colorimeter.
13. Insert the cuvette into the AQ4000. Align the ▼ on the Auto-Test cuvette with the ◆ on the adapter to obtain a continuous beeping and view \*\*\*\*\* across the display. If \*\*\*\*\* and beeping are not observed, rotate the cuvette right or left to initiate the measurement. If using a standard type cuvette, press .
14. Cover the cuvette. When the wait time is complete, the concentration of sample will be displayed. Once verification has been completed, return to the measure mode by pressing .



## Digits

The digit selection allows the user to select the resolution of the reading, from 0.000 → 0.00 → 0.0 → 0. The default is 0.000.





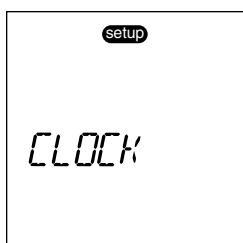

1. Press .
2. Press  or  until "DIGITS" is displayed.
3. Press  to accept.
4. Press  or  until the desired resolution is selected.
5. Press  to accept.

## Clock

The clock menu allows the user to set the time and date.









1. Press .
2. Press  or  until "CLOCK" is displayed.
3. Press  to accept.
4. "20\_ \_" will be displayed. Enter the year.
5. "\_ \_ MONTH" will be displayed. Enter the month.
6. "\_ \_ DAY" will be displayed. Enter the day.
7. "\_ \_ : \_ \_ (24) HOUR" will be displayed. Enter the time.

## Set Baud

The default baud rate is 1200. The user may select the baud rate of 1200, 2400, 4800 or 9600.







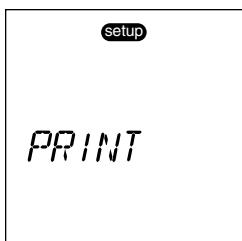

1. Press .
2. Press  or  until “SET BAUD” is displayed.
3. Press  to accept. 1200 or the last baud rate is displayed.
4. Press  or  until the desired baud rate is selected.
5. Press  to accept.

## Print

The print menu allows the user to select the printout format. The user can select between a standard printout (lines are separated) or a comma delimited (lines are not separated) format for importing data into a spreadsheet.







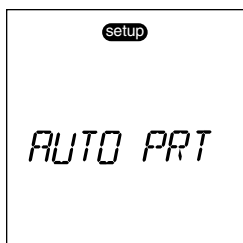

1. Press .
2. Press  or  until “PRINT” is displayed.
3. Press  to accept. “STND PRN?” will be displayed.
4. Press  or  to toggle between “STND PRN?” and “CMA DELM?”.
5. Press  to accept.

## Auto Print

Turning on the auto print function will automatically send readings to the printer.



1. Press .
2. Press  or  until "AUTO PRT" is displayed.
3. Press  to accept. "AUTO OFF?" or "AUTO ON?" will be displayed.
4. Press  or  to toggle between "AUTO OFF?" and "AUTO ON?".
5. Press  to accept.

## Self Test

The self test puts the colorimeter into a self diagnostic mode. See the **Troubleshooting** section.







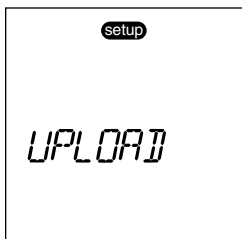

## Methods Update

The AQ4000 will never be obsolete. The colorimeter allows the user to update the method parameters whenever new parameters are released. The update setup function is the process by which a user can add these new methods to their unit.

### AQ4000



1. With the power off, insert the RS232 cable (Cat. No. AQ4CBL) into the AQ4000 RS232 port. A serial adapter may be required. See **Figure 7**.
2. Press .
3. Press .
4. Press  or  until "UPLOAD" is displayed.
5. Press  to accept.
6. The meter will display "WAITING".

**Note:** To abort the upload, press  again.

### Computer

1. Install the RS232 cable into the serial port of the computer.
2. Install the program disk into the disk drive or select the file.
3. Double click on the file to open it.
4. Follow the instructions provided on your computer screen.

## Chapter 4 User Programs









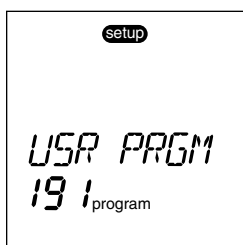





### Custom User Programs

To program the AQ4000 with a user program, enter a program number reserved for user programs. User program numbers are program number 190 through 199.

1. To enter a user program, press .
2. Enter the program number (190 to 199) for a user program.
3. The AQ4000 will either display “NO USER X” or “\*\* USER X” if a program is stored in the memory at that location. If a user program already exists, the user can choose to overwrite it or select another program number.

### Enter a User Program



1. Press .
2. Press  or  until “USR PRGM” is displayed.
3. Press  to accept.
4. “WAVELENGTH?” will be displayed. Toggle between “REVIEW?” or “REPL OLD?”. Press  to accept. Press  or  to select the wavelength for analysis. The available wavelength options are 420, 520, 580 and 610.
5. Press  to accept the wavelength selection.
6. “UNITS” will be displayed. Press  or  to select the units displayed for the analysis. The available units ppb, ABS, %T, g/L, mg/L, µg/L and ppm.
7. Press  to accept the unit selection.
8. “Timer 1?” will be displayed. Press  to set the first timer. Press  or  to set the timer to the desired value.
9. Press  to accept.

10. “Timer 2?” will be displayed. Press to set the second timer. Press or to set the timer to the desired value. To bypass the second timer, press again.

11. Press to accept.

12. “SAVE USR?” will be displayed. If the second timer was bypassed, press to display "SAVE USR?". Press to save the program. “—SAVED—” will be displayed. The AQ4000 will automatically proceed to “CAL USR”.







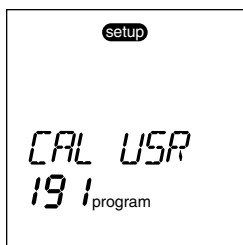





**Note:** To escape without saving program, press when the meter displays the “SAVE USR?” prompt.

**Note:** The AQ4000 requires a calibration to be entered to use a custom program.

## Calibrate a User Program



To access “CAL USR” from the setup menu:

1. Press .
2. Press  or  until “CAL USR?” is displayed.
3. Press  to accept.
4. “3 CAL PTS?” will be displayed. Press  or  to select the number of desired calibration points from 2 to 5.
5. Press  to accept number of calibration points.
6. “PT1 CONC?” will be displayed. Place the cuvette with the first standard in the AQ4000. Ensure that the standard has been properly reacted and cover it with the cuvette cover.
7. Enter the value of the first standard using the numeric keypad. Press  to accept the value. If entering a number with a decimal, press . If no decimal is required, press  twice to accept the value.
8. The AQ4000 will read first standard and automatically proceed to second point.
9. “PT2 CONC?” will be displayed. Place the cuvette with the second standard in the AQ4000. Ensure that the standard has been properly reacted and cover it with the cuvette cover.
10. Enter the value of the second standard using the numeric keypad. Press  to accept the value. If entering a number with a decimal, press . If no decimal is required, press  twice to accept the value.
11. Repeat steps 9 and 10 for each of the remaining standards.
12. “CAL OK” will be displayed at the completion of the calibration. Proceed to the measurement section to measure samples using the user program.

- Notes**
- A calibration must be performed with at least two points prior to the AQ4000 allowing the user to measure with a user program.
  - The instrument should be zeroed before calibration.
  - It is recommended that the calibration bracket the expected sample concentration.
  - When using a custom program, calculation of unknown sample concentration is based on only two of the calibration points that were measured. Generally the points selected will bracket the sample concentration.



## Chapter 5 Measurement

Below are general instructions for using Auto-Test cuvettes, which work with the Auto-ID feature in the AQ4000. For specific test information, refer to instructions provided with test kits.

For the best results, always cover the cuvette with the cuvette cover whenever zeroing or measuring a sample.

### **Zero Procedure**

The zero function sets a zero reference for the measurement. The AQ4000 must be zeroed prior to each series of measurements. The zero is done using unreacted sample or distilled water in a zero cuvette. The AQ4000 is shipped with a zero cuvette kit, Cat. No. AQ4ZER. Included in the kit are three zero cuvettes. One zero cuvette is filled with distilled water and sealed. This can be used if your unreacted sample is very clean and colorless. Two additional zero cuvettes with removable caps are provided. These cuvettes can be used for sample that has any color or turbidity to them. Both types of zero cuvettes have an Auto-ID code. Choose the cuvette most appropriate for your type of measurement.

When a zero is performed, it is a universal zero and all wavelengths are zeroed at the same time. For the best results, perform a zero before each new type of test. If zeroing with a colored sample and the next sample is clear, repeat the zero. If using a colored sample with one test only, you may choose to use the blank function.

## Zero with an Auto-Test Cuvette

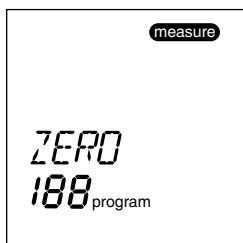



**Note:** For best results, zero before each new method.

1. Press  to turn on the AQ4000 colorimeter. Ensure that the correct adapter is in place.
2. Insert an Auto-Test zero cuvette into the sample well of the AQ4000.
3. Insert the cuvette into the AQ4000. Align the ▼ on the Auto-Test cuvette with the ◆ on the adapter to obtain a continuous beeping and view \*\*\*\*\* across the display. If \*\*\*\*\* and beeping are not observed, rotate the cuvette right or left to initiate the measurement.
4. “COVER VIAL” will be displayed. Immediately cover the cuvette with the cuvette cover.
5. “WAIT” and “ZERO” will be displayed. Allow the AQ4000 to take the zero reading.
6. When complete, “0.000”, “ZERO” and “0 program” will be displayed.
7. Remove the cuvette cover and zero Auto-Test cuvette.

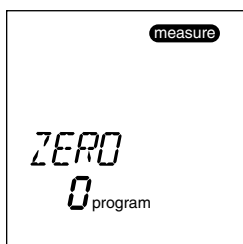
## Zero with a Standard Cuvette



1. Press  to turn on the AQ4000 colorimeter.
2. Press  to select program to run.
3. “ENT PRGM?” will be displayed. Enter the desired program number.
4. Fill a clean dry cuvette with zero solution.
5. Insert the zero cuvette into the colorimeter and cover it with the cuvette cover.
6. Press .
7. “WAIT” and “ZERO” will be displayed. Allow the AQ4000 to take the zero reading.
8. When complete, “ZERO” and “0 program” will be displayed.
9. Remove the cover and zero cuvette.

# Sample Measurement



Instruction sheets for all the AQ4000 chemistries are available at [www.thermo.com/water](http://www.thermo.com/water). General instructions are as follows.

## Measurement with an Auto-Test Sample Cuvette

1. Place the required amount of sample in the provided graduated sample cup. The sample cup is marked in 5 mL increments.
2. Add any required reagents as described in the test instructions.
3. Place the Auto-Test cuvette in the sample cup and snap the tip by pressing the cuvette stem against the side of the cup. Allow the Auto-Test cuvette to fill.
4. Small air bubbles in cuvette facilitate mixing. Invert the Auto-Test cuvette several times to mix. Wipe any liquid from the outside of the cuvette before measurement with a lint-free tissue.
5. Insert the cuvette into the AQ4000. Align the ▼ on the Auto-Test cuvette with the ◆ on the adapter to obtain a continuous beeping and view \*\*\*\*\* across the display. If \*\*\*\*\* and beeping are not observed, rotate the cuvette right or left to initiate the measurement.
6. Immediately cover the cuvette with the cuvette cover.
7. If a wait time is required, the AQ4000 will begin to countdown. The AQ4000 will automatically proceed to the measure mode when the wait time is complete.
8. The AQ4000 will display the result. Record the value or log the data by pressing . Proceed with the next sample.
9. To initiate the next sample, repeat steps 1 through 8.

**Note:** To bypass the timer, press  to stop the timer and the initiate measurement.

## Measurement with a Standard Cuvette and Reagent

1. Follow the instructions provided with the prepared colorimetric test kit sample.
2. Select the program by pressing  and enter the appropriate program number. See the **List of Program Numbers** section.
3. Choose the appropriate size adapter for your cuvette. Insert the adapter into the sample well, ensuring that the slots and male tabs are aligned while pushing it into position.
4. Cap the cuvette and insert the sample in the AQ4000 sample well. Cover the cuvette with the sample cover.
5. Press  to initiate the measurement.
6. If the test has a wait period for sample color development, the countdown will begin. The AQ4000 will automatically proceed to the measure mode when the wait time is complete.
7. The AQ4000 will display the result. Record the value or log the data. Proceed with the next sample.

**Note:** If you have already waited the appropriate time, you can cancel the timer and go directly to the measure mode by pressing .

## Chapter 6 Log and Interface Functions





### Log Function

The AQ4000 colorimeter allows the user to store up to 100 points in the log.



### Log Data



Once a measurement is complete, press  to log the point prior to the next measurement.

### Display the Log

1. Press and hold  for approximately 3 seconds.
2. “DISPLAY” and last point in log will be displayed.
3. Press  or  to scroll through the log points.
4. Press  to escape the log display mode

### Clear the Log

1. Press and hold  for approximately 3 seconds.
2. “DISPLAY” and last point in log will be displayed.
3. Press  and “CLR LOG?” will be displayed.
4. Press  to clear the log. “DELETE” will be displayed and the AQ4000 will return to the measure mode.

**Note:** It is recommended to print or download the log prior to clearing it. Press  instead of  in step 4 to abort the log clear.

### Print or Download the Log

1. Plug the serial cable, Cat. No. AQ4CBL, into the AQ4000.
2. Connect the AQ4CBL cable to a printer or computer. See the **Setup Menu, Print** section.
3. Go to the log display mode and press .

## Interfacing with Printers and Computers







The AQ4000 colorimeter allows communication to a printer or bidirectional communication with a computer for the download of new methods. When connecting to a printer or a computer, use the Cat. No. AQ4CBL cable. This cable has a special 3 pin connector on one end for the AQ4000. When used to connect to a computer, a serial adapter may be required (25 pin to 9 pin adapter is included with Cat. No. AQ4CBL).

### Data Transmission Settings

<b>Baud Rate (Selectable)</b>	1200 (default), 2400, 4800, 9600
<b>Parity</b>	None
<b>Data Bits</b>	8
<b>Start Bit</b>	1
<b>Stop Bit</b>	1

## Chapter 7 Customer Services

### Colorimeter Self Test

1. To initiate the self test, press .
2. Press  or  until display reads “SELFTEST”.
3. Press  to initiate the self test.
4. When “PRESS 7” is displayed, press  and follow the directions through the test.
5. When complete, the meter should display “UNIT OK”.
6. Press any key to confirm the display operation.
7. Press any key to exit the self test.
8. Press  to return to measurement mode or press  to proceed through the setup menu.

### Operator Assistance Codes

Operator Assistance Codes are used to inform a user of a problem during operation. Contact our Technical Support department for assistance.

Error Code	Error Code Type
E11	Internal hardware error
E12	Internal hardware error
E13	Internal hardware error
E14	Internal hardware error
E19	Internal hardware error
E19	LCD driver error
OVERRNG	Measurement exceeds upper operational range
UNDRNG	Measurement exceeds lower operational range

### Maintenance

- Wipe the outside of the colorimeter with a damp cloth.
- Use a lens tissue or a soft cloth to wipe off the sample compartment.
- Always wipe moisture and any fingerprints off of the cuvette before inserting it into the AQ4000 colorimeter.

## Assistance

After troubleshooting all components of your measurement system, contact Technical Support. Within the United States call 1.800.225.1480 and outside the United States call 978.232.6000 or fax 978.232.6031. In Europe, the Middle East and Africa, contact your local authorized dealer. For the most current contact information, visit [www.thermo.com/contactwater](http://www.thermo.com/contactwater).

## Warranty

For the most current warranty information, visit [www.thermo.com/water](http://www.thermo.com/water).

## Declaration of Conformity

### Manufacturer:

Thermo Fisher Scientific  
166 Cummings Center  
Beverly, MA 01915 U.S.A.

**Hereby declares that the Colorimeter Model AQ4000 product conform with the following standards and documents**

**Safety** EC Directive 72/23/EEC Low Voltage Directive

**EMC** EC 89/336/EEC Electromagnetic Compatibility  
EN/IEC 61326:1997 + A1: 1998, Annex C

**Emissions:** EN 55011 (Class A) Emissions  
FCC Part 15 Class A  
Canadian Emissions (EMCAB-3 ISSUE 2)

**Immunity:** DIN EN 50082-2 Feb.1996 Generic Immunity  
IEC 61000-4-2 March 1996 ESD Susceptibility  
IEC 61000-4-3 1995 Radiated Immunity

This Thermo Scientific Orion product has been manufactured in compliance with the provisions of the relevant manufacturing and test documents and processes. Further, these documents and processes are recognized as complying with ISO 9001:2008 by QMI, listed as File number 001911.



---

Patrick Chiu  
Senior Quality Engineer,  
Regulatory Compliance

Beverly, MA  
April 15, 2009



## List of Program Numbers

Program ID	Cat. No.	Test
005	AC4035	Bromine
006	AC4099	Chlorine dioxide
007	AC4029	Copper (soluble)
008	AC4006	Cyanide (free)
009	AC4030	Hydrazine
010	AC4078	Iron 1 (total and soluble)
011	AC4042	Molybdate
012	AC4004	Nitrate (as N) - LR
013	AC4005	Nitrate 2 (as N) - MR
014	AC4007	Nitrate 3 (as NO <sub>3</sub> ) - HR
015	AC4008	Oxygen
016	AC4048	Ozone
017	AC4095	Phosphate 2 - LR
018	AC4096	Phosphate 1 - HR
019	AC4060	Silica
020	AC4016	Sulfide (soluble)
021	AC4065	Zinc
022	AC4070	Chlorine (free and total)
023	AC4012	Ammonia (low range)
024	AC4011	Ammonia (high range)
025	AC4046	Nitrite
026	AC4009	Fluoride
027	AC4082	Sulfate
028	AC4055	Manganese
031	AC4017	Chloride
033	AC4027	Aluminum
034	AC4010	Ammonia ULR
041	CODL00	COD 0 to 150 ppm
042	CODH00	COD 0 to 1,500 ppm
043	CODHP0	COD 0 to 15,000 ppm
050	AC4P71	Chlorine free, powder chemistry
051	AC4P72	Chlorine total, powder chemistry
052	AC4P29	Copper Bicinchorinate, powder chemistry
053	AC4P78	Iron, Ferro, powder chemistry
054	AC4P79	Iron, TPTZ, powder chemistry
055	AC4P55	Manganese HR, powder chemistry
056	AC4P42	Molybdenum, molybdate HR, powder chemistry
057	AC4P46	Nitrite LR, powder chemistry
058	AC4P12	Ammonia as nitrogen, powder chemistry

Program ID	Cat. No.	Test
059	AC4P95	Phosphorus LR, powder chemistry
060	AC4P60	Silica HR, powder chemistry
061	AC4P82	Sulfate 4, powder chemistry
128	AC2007	Nitrate, tablet chemistry
129	AC2078	Iron LR, tablet chemistry
130	AC2078	Iron HR, tablet chemistry
131	AC2012	Ammonia as nitrogen LR, tablet chemistry
132	AC2012	Ammonia as nitrogen HR, tablet chemistry
133	AC2070 AC2071 AC2072	Chlorine free and total, tablet chemistry
134	AC2009	Fluoride
135	AC2002	Alkalinity, tablet chemistry
136	AC2027	Aluminum, tablet chemistry
137	AC2029	Copper, Biquinoline, tablet chemistry
138	AC2065	Copper LR, tablet chemistry
139	AC2055	Manganese, tablet chemistry
140	AC2046	Nitrite, tablet chemistry
141	AC2096	Phosphorus HR, tablet chemistry
142	AC2095	Phosphorus LR, tablet chemistry
143	AC2016	Sulfide, tablet chemistry
144	AC2082	Sulfate, tablet chemistry
145	AC2065	Zinc, tablet chemistry
147	AC2017	Chloride, tablet chemistry
149	AC2030	Hydrazine, tablet chemistry
151	AC2001	pH, tablet chemistry
152	AC2060	Silica, tablet chemistry

## Method Instruction Sheets

The method instruction sheets for the Thermo Scientific Orion AQUAfast IV Auto-Test reagents, COD chemistries, powder chemistries and tablet chemistries can be found at [www.thermo.com/water](http://www.thermo.com/water).

## Ordering Information

Cat. No.	Description
AQ4000	AQUAfast IV advanced colorimeter
AQ4CBL	AQUAfast IV RS232 cable
AQ40FK	AQUAfast IV field case
AQ4ZER	AQUAfast IV Auto-ID zero kit
AC2V24	24 mm cuvettes, 12 pack
AC2V16	16 mm cuvettes, 10 pack

## Auto-Test Ampoule Chemistries

Cat. No.	Description
AC4027	AQUAfast IV aluminum Auto-Test, 30 tests
AC4010	AQUAfast IV ammonia ULR Auto-Test, 30 tests
AC4012	AQUAfast IV ammonia LR Auto-Test, 30 tests
AC4011	AQUAfast IV ammonia HR Auto-Test, 30 tests
AC4035	AQUAfast IV bromine Auto-Test, 30 tests
AC4017	AQUAfast IV chloride Auto-Test, 30 tests
AC4070	AQUAfast IV chlorine (free and total) Auto-Test, 30 tests
AC4099	AQUAfast IV chlorine dioxide Auto-Test, 30 tests
AC4029	AQUAfast IV copper (soluble) Auto-Test, 30 tests
AC4006	AQUAfast IV cyanide (free) Auto-Test, 30 tests
AC4009	AQUAfast IV fluoride SPADNS Auto-Test, 30 tests
AC4030	AQUAfast IV hydrazine Auto-Test, 30 tests
AC4078	AQUAfast IV iron 1 (total and soluble) Auto-Test, 30 tests
AC4055	AQUAfast IV manganese Auto-Test, 30 tests
AC4042	AQUAfast IV molybdate Auto-Test, 30 tests
AC4004	AQUAfast IV nitrate (as N) LR Auto-Test, 30 tests
AC4005	AQUAfast IV nitrate 2 (as N) MR Auto-Test, 30 tests
AC4007	AQUAfast IV nitrate 3 (as NO <sub>3</sub> ) HR Auto-Test, 30 tests
AC4046	AQUAfast IV nitrite Auto-Test, 30 tests
AC4008	AQUAfast IV oxygen Auto-Test, 30 tests
AC4048	AQUAfast IV ozone Auto-Test, 30 tests
AC4095	AQUAfast IV phosphate 2 LR Auto-Test, 30 tests
AC4096	AQUAfast IV phosphate 1 HR Auto-Test, 30 tests
AC4060	AQUAfast IV silica Auto-Test, 30 tests
AC4082	AQUAfast IV sulfate Auto-Test, 30 tests
AC4016	AQUAfast IV sulfide (soluble) Auto-Test, 30 tests
AC4065	AQUAfast IV zinc Auto-Test, 30 tests

**Tablet Chemistries**

<b>Cat. No.</b>	<b>Description</b>
AC2002	Alkalinity-m, 100 tests
AC2027	Aluminum, 50 tests
AC2012	Ammonia as N (2 ranges), 50 tests
AC2035	Bromine, 100 test
AC2017	Chloride, 50 tests
AC2070	Chlorine free and total, 50 tests
AC2071	Chlorine free, 100 tests
AC2072	Chlorine total, 100 tests
AC2029	Copper (Biquinoline), 50 tests
AC2065	Copper/zinc, 50 tests
AC2098	Cyanuric acid, 100 tests
AC2009	Fluoride SPADNS (liquid chemistry), 50 tests
AC2030	Hydrazine, 100 tests
AC2078	Iron (2 ranges), 100 tests
AC2055	Manganese, 50 tests
AC2007	Nitrate, 50 tests
AC2046	Nitrite, 100 tests
AC2048	Ozone, 100 tests
AC2001	pH, 100 tests
AC2095	Phosphate LR, 50 tests
AC2096	Phosphate HR, 50 tests
AC2060	Silica, 50 tests
AC2082	Sulfate, 100 tests
AC2016	Sulfide, 50 tests
AC2065	Zinc/copper, 50 tests

**Chemical Oxygen Demand (COD)**

<b>Cat. No.</b>	<b>Description</b>
COD125	Thermoreactor for digestions to 150 °C
CODL00	COD, 0 to 150 ppm, 25 tests
CODL00B1	COD, 0 to 150 ppm, 100 tests
CODL00B3	COD, 0 to 150 ppm, 300 tests
CODH00	COD, 0 to 1500 ppm, 25 tests
CODH00B1	COD, 0 to 1500 ppm, 100 tests
CODH00B3	COD, 0 to 1500 ppm, 300 tests
CODHP0	COD, 0 to 15000 ppm, 25 tests
CODS01	COD, 1000 ppm standard, 475 mL
CODS10	COD, 10000 ppm standard, 475 mL

**Powder  
Chemistries**

<b>Cat. No.</b>	<b>Description</b>
AC4P12	Ammonia as N HR powder packs, 100 tests
AC4P71	Chlorine free powder packs, 100 tests
AC4P71B	Chlorine free powder packs, 1000 tests
AC4P72	Chlorine total powder packs, 100 tests
AC4P72B	Chlorine total powder packs, 1000 tests
AC4P29	Copper (Bicinchoninate) powder packs, 100 tests
AC4P78	Iron Ferro powder packs, 100 tests
AC4P79	Iron TPTZ powder packs, 100 tests
AC4P55	Manganese HR powder packs, 100 tests
AC4P42	Molybdenum, Molybdate HR powder packs, 100 tests
AC4P46	Nitrite LR powder packs, 100 tests
AC4P95	Phosphorus 3 LR powder packs, 100 tests
AC4P60	Silica HR powder packs, 100 tests
AC2061	Silica phosphate removal powder packs, 100 tests
AC4P82	Sulfate 4 powder packs, 100 tests

# Specifications

<b>AQ4000 Colorimeter</b>	
Wavelength (nm)	420, 520, 580, 610
Wavelength Accuracy	± 2 nm
Wavelength Selection	Automatic
Photometric Linearity	± 0.002 A (0 to 1 A)
Photometric Reproducibility	± 0.005 A (0 to 1 A)
Photometric Accuracy	± 0.005 A @ 1.0 ABS nominal
Photometric Range	0 to 2 A
Stray Light	< 1.0 % at 400 nm
Source Lamp	Light emitting diode (LED)
Detector	Photodiode
Bandwidth	10 ± 2 nm
Display	Custom LCD
Units	mg/L, ppm, µg/L, absorbance or % transmittance
Low Battery Indicator	Yes
RS232	Yes
<b>Software Features</b>	
Programmed Methods	190 and 10 user defined
Datalogging	100 points
Built-in Timer	Yes
Zero and Blank	Yes
Standby Mode	Yes
Capability for Downloading of New Methods	Yes
<b>Electrical Features</b>	
Power	4 AA batteries
Battery Life	2,500 hours (Alkaline) 10,000 hours (Lithium)
Non-volatile Memory	Yes
<b>Environmental Conditions</b>	
Temperature Operating Range	0.0 to 45.0 °C
Humidity	90% at 50.0 °C max
Waterproof	IP67
<b>Inputs</b>	
Keypad	12 dual function keys with tactile feedback
RS232	Yes
Sample Chamber	24 mm, 16 mm and 13 mm
Auto-Test™ Recognition	13 mm cuvette only

## Water Analysis Instruments



### North America

166 Cummings Center  
Beverly, MA 01915 USA  
Toll Free: 1-800-225-1480  
Tel: 1-978-232-6000  
Dom. Fax: 1-978-232-6015  
Int'l Fax: 978-232-6031

### Europe

P.O. Box 254, 3860 AG Nijkerk  
Wallerstraat 125K, 3862 CN Nijkerk,  
Netherlands  
Tel: (31) 033-2463887  
Fax: (31) 033-2460832

### Asia Pacific

Blk 55, Ayer Rajah Crescent  
#04-16/24, Singapore 139949  
Tel: 65-6778-6876  
Fax: 65-6773-0836

[www.thermo.com/water](http://www.thermo.com/water)

© 2009 Thermo Fisher Scientific Inc. All rights reserved.

263511-001 Rev. A 04-09

**Thermo**  
SCIENTIFIC