

R55FPG W/30

Photoelectric Sensor – Photoelectric Sensor for Plastic Fibers

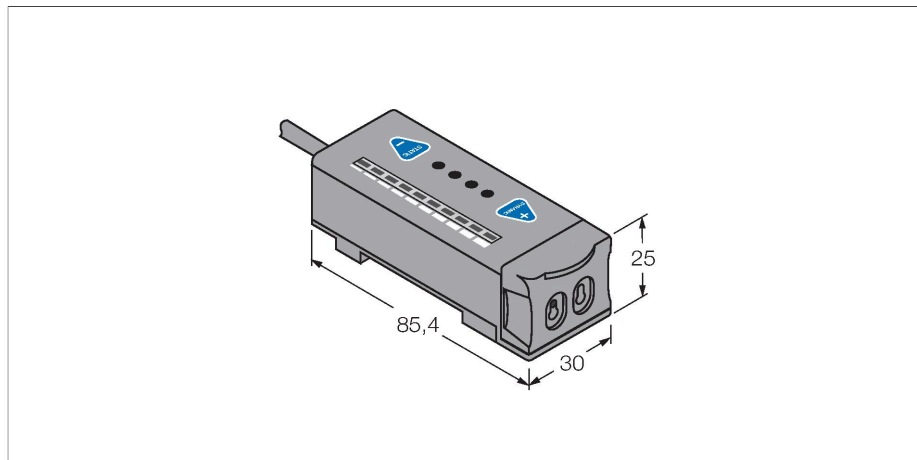

Features

- Cable, PVC, 9 m, 5-wire
- Protection class IP67
- Teach button
- 10-segment bargraph
- Switch-off delay (no delay, 20 ms, 40 ms)
- Green emitter LED
- Operating voltage: 10...30 VDC
- Switching output, bipolar
- Light or dark operation

Wiring diagram

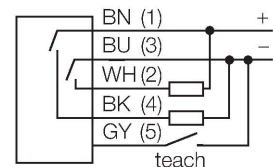

Functional principle

Glass or fibre optic sensors are the optimum choice for high temperature or space restricted applications. Fibre optics transfer the light from the sensor to a remote object. Individual fibre optics are used for opposed mode sensing, whereas bifurcated fibre optics are suited for diffuse mode operation.

Technical data

Type	R55FPG W/30
ID	3058022
Optical data	
Function	Fiber optic sensor
Operating mode	Plastic fiber
Fiber-optic type	plastic
Light type	Green
Wavelength	525 nm
Electrical data	
Operating voltage	10...30 VDC
Residual ripple	< 10 % U _{ss}
No-load current	≤ 70 mA
Short-circuit protection	yes
Reverse polarity protection	yes
Output function	NO contact, PNP/NPN
Switching frequency	10 kHz
Readiness delay	≤ 100 ms
Response time typical	< 0.05 ms
Setting option	Push Button Remote Teach
Mechanical data	
Design	Rectangular, R55F
Dimensions	85.4 x 30 x 25 mm
Housing material	Plastic, Thermoplastic material, Black
Electrical connection	Cable, 9 m, PVC
Number of cores	5
Core cross-section	0.34 mm ²

Technical data

Ambient temperature	-10...+55 °C
Relative humidity	0...90 %
Protection class	IP67
Special features	keep/defer Wash down
Power-on indication	LED, Green
Switching state	LED, Green
Excess gain indication	Bargraph, green
Tests/approvals	
MTTF	178 years acc. to SN 29500 (Ed. 99) 40 °C
Approvals	CE

Accessories

SMBR55F01	3067104	SMBR55FRA	3058809
	Mounting panel, PBT, black, for R55F series, wall mounting		Mounting bracket, 19-ga. stainless steel, for D10, DF-G1 and R55F series, lateral wall mounting
DIN-35-70	3026604	DIN-35-105	3030470
	DIN rail, width 35 mm, length 70 mm		DIN rail, width 35 mm, length 105 mm
DIN-35-140	3026605		
	DIN rail, width 35 mm, length 140 mm		

Accessories

Dimension drawing	Type	ID	
	PBT16U	3042822	Plastic fiber-optic sensor, operating mode: Diffuse mode, threaded sleeve M3 x 0.75 mm, field wireable wire without end tip, polyethylene sheath, ambient temperatures -30 °C...+70 °C
	PBT26U	3026080	Plastic fiber, sensing mode: Diffuse mode, threaded bush M3 x 0.75 mm, preassembled wire without end tip, polyethylene jacket, ambient temperatures -30 °C...+70 °C

Dimension drawing	Type	ID	
	PBT46U	3025967	Plastic fiber-optic sensor, operating mode: Diffuse mode, threaded sleeve M3 x 0.75 mm, field wireable wire without end tip, polyethylene sheath, ambient temperatures -30 °C...+70 °C

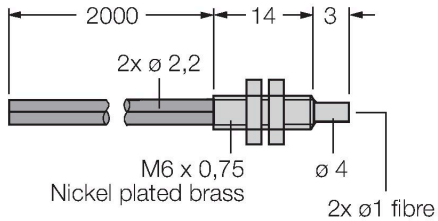

PBT66U	3039982
--------	---------

Plastic fiber-optic sensor, operating mode: Diffuse mode, threaded sleeve M6 x 0.75 mm, pre-assembled wire without end tip, polyethylene sheath, ambient temperatures -30 °C...+70 °C

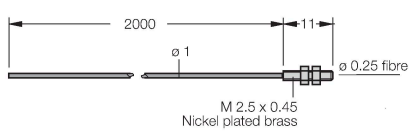
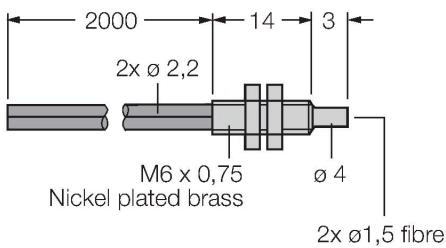

PIT16U	3039983
--------	---------

Plastic fiber-optic sensor, operating mode: Opposed mode, threaded sleeve M3 x 0.5 mm, field wireable wire without end tip, polyethylene sheath, ambient temperatures -30 °C...+70 °C

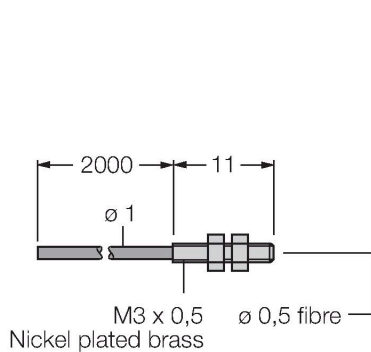

PIT26U	3026079
--------	---------

Plastic fiber, sensing mode: Opposed mode, threaded bush M3 x 0.5 mm, preassembled wire without end tip, polyethylene jacket, ambient temperatures -30 °C...+70 °C

Dimension drawing	Type	ID	
	PIT46U	3026034	Plastic fiber-optic sensor, operating mode: Opposed mode, threaded sleeve M3 x 0.5 mm, field wireable wire without end tip, polyethylene sheath, ambient temperatures -30 °C...+70 °C

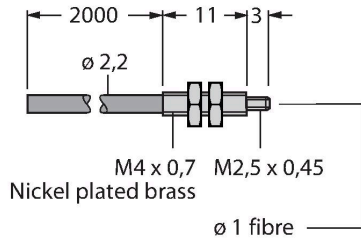

PIT66U	3039899
--------	---------

Plastic fiber-optic sensor, operating mode: Opposed mode, threaded sleeve M3 x 0.5 mm, field wireable wire without end tip, polyethylene sheath, ambient temperatures -30 °C...+70 °C

