

arteche



AUXILIARY RELAYS FOR
RAILWAY SECTOR.

This document may be subject to changes. Contact ARTECHE to confirm the characteristics and availability of the products described here.



Moving together

INDEX

- 4. › Answers for railway applications
- 5. › General characteristics
- 6. › Technical standards
- 7. › Range of products
- 8. › Railway applications
- 9. › Instantaneous relays
- 16. › Time-Lag relays
- 18. › Latching relays
- 23. › Breaking capacity
- 28. › Pick-up voltage/release voltage-temperature charts
- 32. › Model selection
- 34. › Dimensions and panel mounting cut-off

ANSWERS FOR RAILWAY APPLICATIONS

ARTECHE auxiliary relays are designed to guarantee the best features and complete security even in the hardest working environment.

The design, durability and quality of the different alternatives that ARTECHE relays can offer (FF range and standard range), make them suitable for high responsibility controls in the railway sector, highlighting:

ELECTRIFICATION:

Traction Substations and Station Centres

- › Direct operation on MV / HV (circuit breaker, sectionalizer).
- › Galvanic isolation between the control system and the primary equipment.
- › Applications where high speed operation is a must.
- › Applications where high breaking capacity is required.
- › Tripping functions.
- › Contact multiplication in control systems of HV / MV installations.

FF RANGE IN THE FOLLOWING APPLICATIONS:

ROLLING STOCK:

- › Boarding doors locking.
- › Brake circuit command.
- › Security loop.
- › Pantograph control.
- › Lighting and air conditioned systems operation.
- › Traction system.
- › Brake systems

INTERLOCKING AND SIGNALLING:

Interface between infrastructure and rolling stock:

- › ASFA systems.
- › RTMC systems.
- › RTMS systems.
- › CBTC systems.
- › ETCS systems.
- › ATO/ATP/ATS/APR... systems

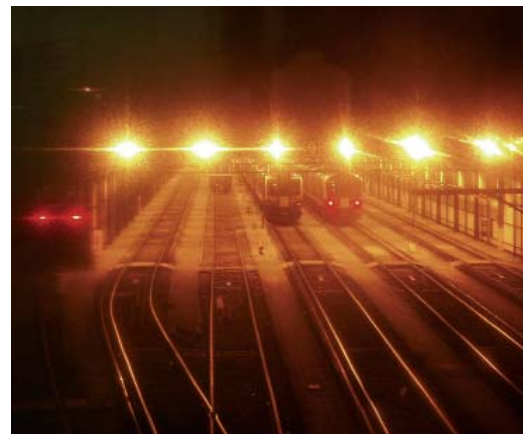

GENERAL CHARACTERISTICS

The main features of ARTECHE's auxiliary relays are the followings:

- › Security contacts (EN 50205 Standard).
- › Capable to withstand vibrations and seismic conditions (EN 61373; IEEE 344; IEEE 323; IEEE C37.98 Standards).
- › Capable to operate under low duty loads, activate digital inputs, and operate without any load. **FF Range.**
- › Wide range of auxiliary voltage levels (Vdc and Vac).
- › Sturdy design.
- › High speed operation (up to 3 ms).
- › Self-cleaning contacts.
- › Designed to allow continuous operation even in high temperature ambient, within the whole voltage range.
- › High level of electrical insulation between input and output circuits.
- › Availability of extended voltage range (+25/-30%) for high security applications.
- › An internal diode is included to avoid damaging the relay when connecting with inverse polarity.
- › In compliance with the most demanding test standards: IEC, EN, IEEE and bearing the CE mark
- › High protection degree (IP40), with transparent cover, making them suitable for use in salty and tropical atmospheres.
- › Capable to work under ambient of 100% humidity.
- › Simplicity of installation (plug-in relays in a wide range of sockets with different installation configurations).
- › No need of maintenance after installation.



In addition, the different number of alternatives that are offered when the equipment is selected, both technically (increase of the breaking capacity by serial contacts or by the magnetic blow out, high speed operation of the output contacts, possibility of adding different options to the relay) and in the assembly method (front, rear or flush mounted sockets, with screws or fastons) must be considered.

TECHNICAL STANDARDS

RAILWAY APPLICABLE STANDARDS

- › **EN 60077 Series.** Rolling stock equipment.
 - Part 1: General conditions in service and general terms.
 - Part 2: Electrotechnical components.
- › **IEC 50155** (IEC 60571 equivalent). Railway applications
 - Rolling stock equipment.
- › **IEC 61373.** Railway applications - Shock and vibration tests.
- › **NFF 16-101 and NFF 16-102.** Rolling stock fire behaviour.
- › **EN 50205.** Relays with forcibly mechanically guided contacts.

GENERAL STANDARDS

In addition to the specific applicable standards, ARTECHE auxiliary relays are designed based on the fulfilment of the following standards:

- › **IEC 61810:** Electromechanical all-or-nothing relays.
- › **IEC 60255:** Electrical relays. Measuring relays and protection equipment.
- › **IEC 61812:** Specified time relays for industrial use.
- › **IEC 60947:** Low-voltage switchgear and controlgear. .
- › **IEC 61000:** Electromagnetic compatibility.

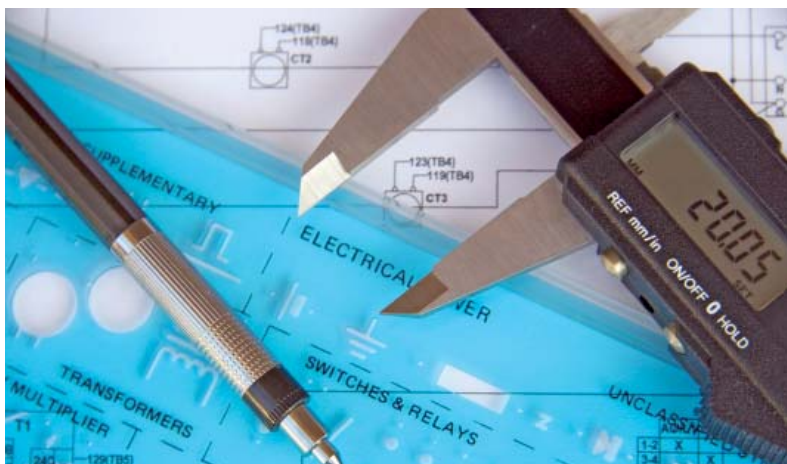

E322124

UL Recognized Component Marks for USA and Canada: The combined UL signs for the USA and Canada are recognized by the authorities of both countries. All auxiliary relays identified with this mark meet the requirements of both countries.

RANGE OF PRODUCTS

ROLLING STOCK / SIGNALLING

Instantaneous, latching and timer relays.

Auxiliary relays with seismic characteristics

ARTECHE's auxiliary relays with seismic characteristics are designed to work properly perform under frequent vibration and shock applications, as railway sector, or because of safety requirements as nuclear power plants.

They comply with the extended voltage range (+25 / -30 %).

The sturdy design of our equipment, with a higher appropriate pressure between contacts, permits to withstand vibrations without penalizing the good performance of the relays.



SIGNALING

Instantaneous relays.

The FF range exhaustive process control ensures a proper operation of the contacts in weak loads or even in no load operations.

ELECTRIFICATION

Instantaneous, latching and timer relays.

General purpose auxiliary relays

ARTECHE's general purpose auxiliary relays are designed to directly operate to the tripping and control circuit.

Their pick-up time lower than 20 ms and the high breaking capacity of their contacts make them appropriate to be used as an interface between the protection system and the breaker. Furthermore, its multiple output contacts permit to use these relays in control, interlocking, timing and signalling applications as well as per direct operation on HV and MV primary equipment.



Auxiliary tripping relays

ARTECHE offers specific relays intended to be used in tripping applications, where the requirements of pick-up time (with models that assure the trip even in less than 3 ms) and the breaking capacity are demanding, as the trip of HV and MV breakers.

These relays include a standard front LED that indicates when the relay is energized. Relay trip flag is available, which indicates when the relay has operated, as a memory state.

All the relays include a diode in parallel with the coil (see auxiliary relays with overvoltage protection characteristic) and comply with the shock and vibration standards, related to the relays with seismic characteristics.



Auxiliary relays with coil overvoltage protection

ARTECHE's auxiliary relays, either Vdc or Vac, have the possibility of including an element in parallel with the coil (diode or varistance).

In applications with overvoltage, where drop-out time is not important, it is recommended to use diode. Otherwise, varistance is more suitable.

These elements are aimed to discharge the energy of the coil when the relay is not longer energized.

These relays are indicated when the customer wish to protect the contact of the equipment that commands the operation of our relay, providing a longer durability of the whole protection and control system.



RAILWAY APPLICATIONS

MODEL	ROLLING STOCK (FF Range)	SIGNALING (FF Range)	INFRASTRUCTURE	CONTACTS	WELD NO TRANSFER CONTACTS
Instantaneous					
RD-2SY	•	•	•	2 CO	•
RF-4SY	•	•	•	4 CO	•
RJ-8SY	•	•	•	8 CO	•
RD-2SYDI / RD-2SYV	•	•	•	2 CO	•
RF-4SYDI / RF-4SYV	•	•	•	4 CO	•
RJ-8SYDI / RJ-8SYV	•	•	•	8 CO	•
RD-2		•	•	2 CO	•
RF-4		•	•	4 CO	•
RJ-8		•	•	8 CO	•
RD-2DI / RD-2V		•	•	2 CO	•
RF-4DI / RF-4V		•	•	4 CO	•
RJ-8DI / RJ-8V		•	•	8 CO	•
Timers					
TDF-2	•	•	•	2 CO	•
TDF-4	•	•	•	4 CO	•
TDF-22	•	•	•	4 CO (2 inst. + 2 timed)	•
TDJ-8	•	•	•	8 CO	•
TDJ-44	•	•	•	8 CO (4 inst. + 4 timed)	•
Latching					
BF-3	•	•	•	3 CO	
BF-4	•	•	•	4 CO	
BJ-8	•	•	•	8 CO	
BF-3BB	•	•	•	3 CO	
BF-4BB	•	•	•	4 CO	
BJ-8BB	•	•	•	8 CO	
Trip					
RD-2R		•	•	2 CO	•
RD-2XR		•	•	2 CO	•
RF-4R		•	•	4 CO	•
RF-4XR		•	•	4 CO	•
RJ-8R		•	•	8 CO	•
RJ-8XR		•	•	8 CO	•
BF-3R		•	•	3 CO	
BF-4R		•	•	4 CO	
BF-4RP		•	•	4 CO	
BJ-8R		•	•	8 CO	
BJ-8RP		•	•	8 CO	

FF Range: Capable to operate under low duty loads, activate digital inputs, and operate without any load: general applications, as for rolling stock as for signaling.

TECHNICAL FEATURES PER MODEL



- › World-class range of auxiliary relays for energy sector, specially designed for the most demanding applications

GENERAL PURPOSE INSTANTANEOUS RELAYS

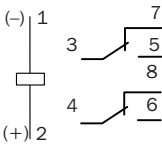
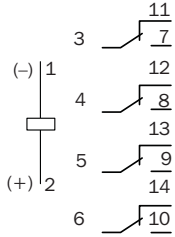
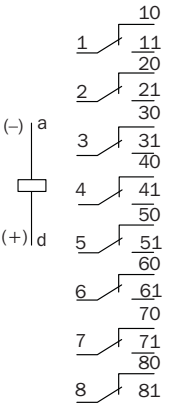
Model	RD-2	RF-4	RJ-8
Applications	Operate directly to the tripping and control circuit.		
Construction characteristics			
Contacts no.	2 Changeover	4 Changeover	8 Changeover
Connections			
Options	With OP options	With OP options - Push-to-test button included	
Weight (g)	125	250	500
Dimensions (mm)	22,5 x 50,4 x 72	42,5 x 50,4 x 72	82,5 x 50,4 x 72
Coil characteristics			
Standard voltages ⁽¹⁾	24, 48, 72, 110, 125, 220 Vdc 24, 48, 63,5, 110, 127, 230, 400 Vac (50-60 Hz) ⁽⁴⁾		
Voltage range	+10% -20% U _N		
Pick-up voltage	See pick-up/release voltage-temperature curves		
Release voltage	See pick-up/release voltage-temperature curves		
Consumptions in permanence (U _N)	2,6 W; 3,3 VA	3,9 W; 6,6 VA	6 W; 11 VA
Operating time			
Pick-up time	<20 ms		
Drop-out time	Vdc: <10 ms • Vac: <50ms With LED: <50ms	Vdc: <15 ms • Vac: <50 ms With LED: <50 ms	
Contacts			
Contact material	AgNi		
Contacts resistance ⁽²⁾	≤30 mΩ / ≤15 mΩ (Range FF)		
Distance between contacts	1,8 mm		
Permanent current	10 A		
Instantaneous current	30 A during 1 s / 80 A during 200 ms / 200 A during 10 ms		
Max. making capacity	40 A / 0,5 s / 110 Vdc		
Breaking capacity	See breaking capacity curves (Contact configuration type A)		
Max. breaking capacity	See value for 50,000 operations		
U _{max} opened contact	250 Vdc / 400 Vac		
Performance data			
Mechanical endurance	10 ⁷ operations		
Operating temperature	-40°C +70°C		
Storage temperature	-40°C +70°C		
Max. operating humidity	93% / +40°C		
Operating altitude ⁽³⁾	<2000 m		





⁽¹⁾ Other voltage upon request

⁽²⁾ Guarantee data for relays just manufactured

⁽³⁾ Ask for higher altitudes

⁽⁴⁾ Voltage not recognized by UL

TRIP RELAYS (I)

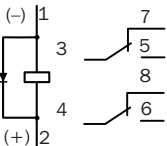
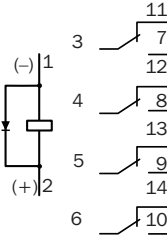
Model	RD-2R	RD-2XR	RF-4R	RF-4XR	
					
Applications	Intended for tripping applications where high demanding requirements in operating time (with tripping time from 8ms to 3 ms) and breaking capacity are needed, that is the case of tripping HV and MV circuit breakers.				
Construction characteristics					
Contacts no.	2 Changeover		4 Changeover		
Connections					
Options	With OP options • LED included • Diode in parallel with the coil included				
Weight (g)	125		250		
Dimensions (mm)	22,5 x 50,4 x 72		42,5 x 50,4 x 72 (F short Type)		
Coil characteristics					
Standard voltages ⁽¹⁾	24, 48, 110, 125, 220, 250 ⁽⁴⁾ Vdc / 110, 127, 230 Vac (50-60Hz)	24, 48, 110, 125, 220, 250 Vdc	24, 48, 110, 125, 220, 250 ⁽⁴⁾ Vdc / 110, 127, 230 Vac (50-60 Hz)	24, 48, 110, 125, 220, 250 ⁽⁴⁾ Vdc	
Voltage range	+10% -20% U _N				
Pick-up voltage	See pick-up/release voltage-temperature curves				
Release voltage	See pick-up/release voltage-temperature curves				
Consumptions	0,95 W		1 W		
	In permanence (U _N)				
	Peak • ≤96 Vdc	0,8 A / 20 ms	2,5 A / 20 ms	0,8 A / 20 ms	2,5 A / 20 ms
	Peak • >96 Vdc	0,3 A / 20 ms	0,8 A / 20 ms	0,3 A / 20 ms	0,8 A / 20 ms
Operating time					
Pick-up time	<8 ms (<10 ms Vac)	<5,5 ms	<8 ms (<10 ms Vac)	<5,5 ms	
Drop-out time	Vdc: <40 ms Vac: <50 ms	Vdc: <40 ms	Vdc: <40 ms Vac: <50 ms	Vdc: <40 ms	
Contacts					
Contact material	AgNi				
Contacts resistance ⁽²⁾	≤30 mΩ				
Distance between contacts	1,2 mm				
Permanent current	10 A				
Instantaneous current	30 A during 1 s / 80 A during 200 ms / 200 A during 10 ms				
Max. making capacity	40 A / 0,5 s / 110 Vdc				
Breaking capacity	See breaking capacity curves (Contact configuration type B)				
Max. breaking capacity	See value for 50.000 operations				
U _{max} opened contact	250 Vdc / 400 Vac				
Performance data					
Mechanical endurance	10 ⁷ operations				
Operating temperature	-25°C +70°C				
Storage temperature	-30°C +70°C				
Max. operating humidity	93% / +40°C				
Operating altitude ⁽³⁾	<2000 m				

⁽¹⁾ Other voltage upon request

⁽²⁾ Guarantee data for relays just manufactured

⁽³⁾ Ask for higher altitudes

⁽⁴⁾ Voltage not recognized by UL



TRIP RELAYS (II)

Model	RJ-8R	RJ-8XR	RJ-4XR4
Applications	Intended for tripping applications where high quality requirements in operating time (with models even tripping in less than 3 ms) and breaking capacity are needed, that is the case of tripping HV and MV circuit breakers.		
Construction characteristics			
Contacts no.	8 Changeover		4 Changeover + 4 Fast Singles-Inversors without break power
Connections			
Options	With OP options • LED included • Diode in parallel with the coil included		
Weight (g)	500		335
Dimensions (mm)	82,5 x 50,4 x 72 (J short type)		42,5 x 50,4 x 82,5 (F short Type)
Coil characteristics			
Standard voltages ⁽¹⁾	24, 48, 110, 125, 220, 250 ⁽⁴⁾ Vdc/110, 127, 230 Vac (50-60 Hz)	24, 48, 110, 125, 220, 250 ⁽⁴⁾ Vdc	110, 125, 220, 250 ⁽⁴⁾ Vdc
Voltage range	+10% -20% U _N		+15% -20% U _N
Pick-up voltage	See pick-up/release voltage-temperature curves		
Release voltage	See pick-up/release voltage-temperature curves		
Consumptions	In permanence (U _N)	1,4 W	6,5 W
	Peak • ≤96 Vdc	0,8 A / 20 ms	2,5 A / 20 ms
	Peak • >96 Vdc	0,3 A / 20 ms	0,8 A / 20 ms
Operating time			
Pick-up time	<8 ms Vdc (<10 ms Vac) (Range 24 Vdc <10 ms)	<6,5 ms	Contacts 1-4: <3 ms Contacts 5-8: <20 ms
Drop-out time	Vdc: <40 ms Vac: <50 ms	Vdc: <40 ms	Contacts 1-4: <25 ms Contacts 5-8: <50 ms
Contacts			
Contact material	AgNi		Contacts 1-4: AgNi 10 Contacts 5-8: Ag1000
Contacts resistance ⁽²⁾	≤30 mΩ		
Distance between contacts	1,2 mm		Contacts 5-8: 1,2 mm
Distance between contacts	10 A		Contacts 5-8: 15 A Contacts 1-4: 8 A
Instantaneous current	30 A during 1 s / 80 A during 200 ms / 200 A during 10 ms		
Max. making capacity	40 A / 0,5 s / 110 Vdc		
Breaking capacity	See breaking capacity curves (Contact configuration type B)		
Max. breaking capacity	See value for 50,000 operations		
U _{max} opened contact	250 Vdc / 400 Vac		
Performance data			
Mechanical endurance	10 ⁷ operations		
Operating temperature	-25°C +70°C		
Storage temperature	-30°C +70°C		
Max. operating humidity	93% / +40°C		
Operating altitude ⁽³⁾	<2000 m		

⁽¹⁾ Other voltage upon request
⁽²⁾ Guarantee data for relays just manufactured

⁽³⁾ Ask for higher altitudes
⁽⁴⁾ Voltage not recognized by UL

INSTANTANEOUS RELAYS WITH SEISMIC CHARACTERISTICS

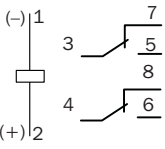
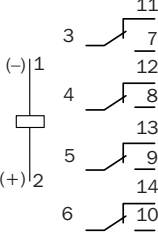
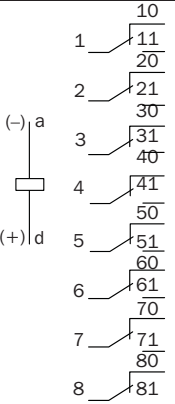
Model	RD-2SY	RF-4SY	RJ-8SY
			
Applications	Frequent vibration and shock applications, as railway sector, or because of safety requirements as nuclear power plants.		
Construction characteristics			
Contacts no.	2 Changeover	4 Changeover	8 Changeover
Connections			
Options	With OP options	With OP options / Push-to-test button included	
Weight (g)	125	250	500
Dimensions (mm)	22,5 x 50,4 x 72	42,5 x 50,4 x 72	82,5 x 50,4 x 72
Coil characteristics			
Standard voltages ⁽¹⁾	24, 48, 72, 110, 125, 220 Vdc 24, 48, 63,5, 110, 127, 230, 400 ⁽⁴⁾ Vac (50-60 Hz)		
Voltage range	+25% -30% U _N		
Pick-up voltage	See pick-up/release voltage-temperature curves		
Release voltage	See pick-up/release voltage-temperature curves		
Consumptions in permanence (U _N)	2,6 W; 3,3 VA	3,9 W; 6,6 VA	6 W; 11 VA
Operating time			
Pick-up time	< 20 ms		
Drop-out time	Vdc: <10 ms / Vac: <50 ms / With LED	Vdc: <15 ms / Vac: <50 ms / With LED	
Contacts			
Contact material	AgNi		
Contacts resistance ⁽²⁾	≤30 mΩ / ≤15 mΩ (FF Range)		
Distance between contacts	1,2 mm		
Permanent current	10 A		
Instantaneous current	30 A during 1 s / 80 A during 200 ms / 200 A during 10 ms		
Max. making capacity	40 A / 0,5 s / 110 Vdc		
Breaking capacity	See breaking capacity curves (Contact configuration type B)		
Max. breaking capacity	See value for 50,000 operations		
U _{max} opened contact	250 Vdc / 400 Vac		
Performance data			
Mechanical endurance	10 ⁷ operations		
Operating temperature	-40°C +70°C		
Storage temperature	-40°C +70°C		
Max. operating humidity	93% / +40°C		
Operating altitude ⁽³⁾	<2000 m		

⁽¹⁾ Other voltage upon request

⁽²⁾ Guarantee data for relays just manufactured

⁽³⁾ Ask for higher altitudes

⁽⁴⁾ Voltage not recognized by UL

INSTANTANEOUS RELAYS WITH COIL OVERVOLTAGE PROTECTION (I)

Model	RD-2DI RD-2V ⁽⁴⁾	RF-4DI RF-4V ⁽⁴⁾	RJ-8DI RJ-8V ⁽⁴⁾
-------	--------------------------------	--------------------------------	--------------------------------



Intended to protect the contact of the equipment that feeds the coil in our relay.

Applications

Construction characteristics

Contacts no.	2 Changeover	4 Changeover	8 Changeover
--------------	--------------	--------------	--------------

Connections

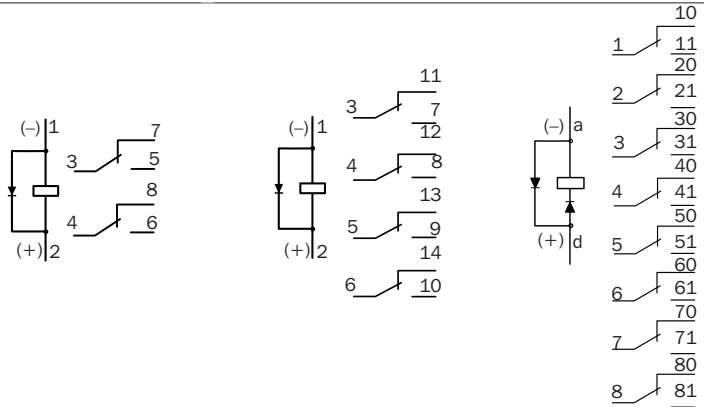

Options	With OP options	With OP options / Push-to-test button included
---------	-----------------	--

Weight (g)	125	250	500
------------	-----	-----	-----

Dimensions (mm)	22,5 x 50,4 x 72	42,5 x 50,4 x 72	82,5 x 50,4 x 72
-----------------	------------------	------------------	------------------

Coil characteristics

Standard voltages ⁽¹⁾	24, 48, 72, 110, 125, 220 Vdc 24, 48, 63,5, 110, 127, 230, 400 ⁽⁴⁾ Vac (50-60 Hz)		
----------------------------------	--	--	--

Voltage range	+10% -20% U _N		
---------------	--------------------------	--	--

Pick-up voltage	See pick-up/release voltage-temperature curves		
-----------------	--	--	--

Release voltage	See pick-up/release voltage-temperature curves		
-----------------	--	--	--

Consumptions in permanence (U _N)	2,6 W; 3,3 VA	3,9 W; 6,6 VA	6 W; 11 VA
--	---------------	---------------	------------

Operating time

Pick-up time	< 20 ms		
--------------	---------	--	--

Drop-out time	V Series: <25ms DI Series: <50 ms		
---------------	--------------------------------------	--	--

Contacts

Contact material	AgNi		
------------------	------	--	--

Contacts resistance ⁽²⁾	≤30 mΩ / ≤15 mΩ (FF Range)		
------------------------------------	----------------------------	--	--

Distance between contacts	1,8 mm		
---------------------------	--------	--	--

Permanent current	10 A		
-------------------	------	--	--

Instantaneous current	30 A during 1 s / 80 A during 200 ms / 200 A during 10 ms		
-----------------------	---	--	--

Max. making capacity	40 A / 0,5 s / 110 Vdc		
----------------------	------------------------	--	--

Breaking capacity	See breaking capacity curves (Contact configuration type A)		
-------------------	---	--	--

Max. breaking capacity	See value for 50,000 operations		
------------------------	---------------------------------	--	--

U _{max} opened contact	250 Vdc / 400 Vac		
---------------------------------	-------------------	--	--

Performance data

Mechanical endurance	10 ⁷ operations		
----------------------	----------------------------	--	--

Operating temperature	-40°C +70°C		
-----------------------	-------------	--	--

Storage temperature	-40°C +70°C		
---------------------	-------------	--	--

Max. operating humidity	93% / +40°C		
-------------------------	-------------	--	--

Operating altitude ⁽³⁾	<2000 m		
-----------------------------------	---------	--	--



⁽¹⁾ Other voltage upon request

⁽²⁾ Guarantee data for relays just manufactured

⁽³⁾ Ask for higher altitudes

⁽⁴⁾ Voltage not recognized by UL

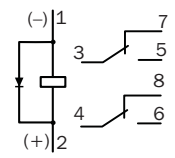
INSTANTANEOUS RELAYS WITH COIL OVERVOLTAGE PROTECTION (II)

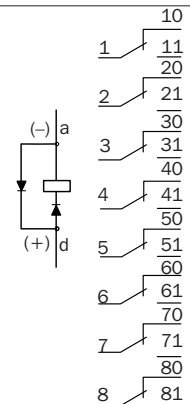
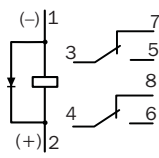
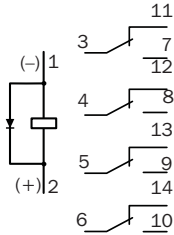
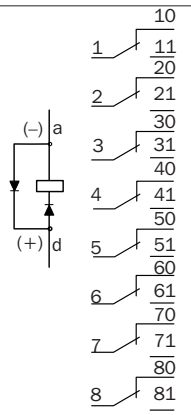
Model	RD-2SYDI RD-2SYV ⁽⁴⁾	RF-4SYDI RF-4SYV ⁽⁴⁾	RJ-8SYDI RJ-8SYV ⁽⁴⁾
			
Applications	Frequent Vibration and Shock applications, as railway sector, or because of safety requirements as nuclear power plants. Intended to protect the contact of the equipment that feeds the coil in our relay.		
Construction characteristics			
Contacts no.	2 Changeover	4 Changeover	8 Changeover
Connections			
Options	With OP options	With OP options / Push-to-test button included	
Weight (g)	125	250	500
Dimensions (mm)	22,5 x 50,4 x 72	42,5 x 50,4 x 72	82,5 x 50,4 x 72
Coil characteristics			
Standard voltages ⁽¹⁾	24, 48, 72, 110, 125, 220 Vdc 24, 48, 63,5, 110, 127, 230, 400 ⁽⁴⁾ Vac (50-60 Hz)		
Voltage range	+25% -30% U _N		
Pick-up voltage	See pick-up/release voltage-temperature curves		
Release voltage	See pick-up/release voltage-temperature curves		
Consumptions in permanence (U _N)	2,6 W; 3,3 VA	3,9 W; 6,6 VA	6 W; 11 VA
Operating time			
Pick-up time	< 20 ms		
Drop-out time	V Series: <25ms DI Series: <50 ms		
Contacts			
Contact material	AgNi		
Contacts resistance ⁽²⁾	≤30 mΩ / ≤15 mΩ (FF Range)		
Distance between contacts	1,2 mm		
Permanent current	10 A		
Instantaneous current	30 A during 1 s / 80 A during 200 ms / 200 A during 10 ms		
Max. making capacity	40 A / 0,5 s / 110 Vdc		
Breaking capacity	See breaking capacity curves (Contact configuration type A)		
Max. breaking capacity	See value for 50,000 operations		
U _{max} opened contact	250 Vdc / 400 Vac		
Performance data			
Mechanical endurance	10 ⁷ operations		
Operating temperature	-40°C +70°C		
Storage temperature	-40°C +70°C		
Max. operating humidity	93% / +40°C		
Operating altitude ⁽³⁾	<2000 m		

⁽¹⁾ Other voltage upon request

⁽²⁾ Guarantee data for relays just manufactured

⁽³⁾ Ask for higher altitudes

⁽⁴⁾ Voltage not recognized by UL

TIME-LAG RELAYS (I)

Model	TDF-2	TDF-4	TDF-22
-------	-------	-------	--------



Applications

Electrical command timing

Construction characteristics

Timing Contacts no.	2 Changeover	4 Changeover	2 Changeover
Instantaneous contact no.	0 Changeover	0 Changeover	2 Changeover

Connections

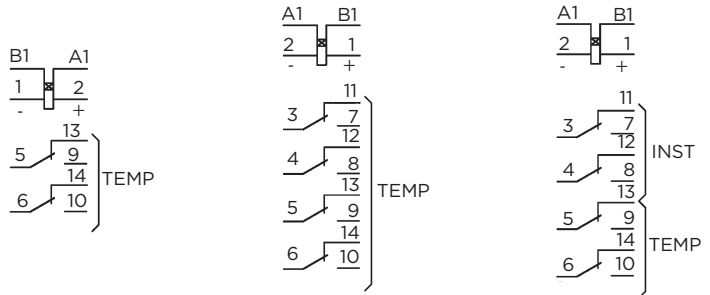

Options

With OP options

Weight (g)	265
Dimensions (mm)	42,5 x 50,4 x 96,6

Coil characteristics

Standard voltages ⁽¹⁾	24, 48, 72, 96, 110, 125, 250 ⁽⁴⁾ Vdc/Vac (50-60 Hz)
Voltage range	+25% -30% U _N (except range 250) ⁽⁴⁾
Pick-up voltage	See power supply-temperature charts for time-lag relays
Release voltage	
Consumptions In permanence (U _N)	≤3,2 W ≤4 W ≤5,5 W

Operating time

Time range	between 0,03 s y 99 h
Pick-up time	< 23 ms
Drop-out time	< 40 ms

Contacts

Contact type	2 Changeover	4 Changeover
Contact material	AgNi (FF Range)	
Contact resistance ⁽²⁾	≤30 mΩ / ≤15 mΩ (FF Range)	
Distance between contacts	1,2 mm	
Permanent current	10 A	
Instantaneous current	30 A 0 A during 1s / 80 A during 200 ms / 200 A during 10 ms	
Max. making capacity	40 A / 0,5 s / 110 Vdc 30 A / 1 s / 36 Vdc / 30.000 operations (1 op / 15 s)	
Breaking capacity	See breaking capacity curves (Contact configuration type B)	
Max. breaking capacity	See value for 50,000 operations	
U _{max} opened contact	250 Vdc / 400 Vac	

Performance data

Mechanical endurance	10 ⁷ operations
Operating temperature	-40°C +70°C
Storage temperature	-40°C +70°C
Max. operating humidity	93% / +40°C
Operating altitude ⁽³⁾	<2000 m

⁽¹⁾ Other voltage upon request

⁽²⁾ Guarantee data for relays just manufactured

⁽³⁾ Ask for higher altitudes

⁽⁴⁾ Voltage not recognized by UL

TIME-LAG RELAYS (II)

Model	TDJ-8	TDJ-44
-------	-------	--------



Applications

Electrical Command Timing

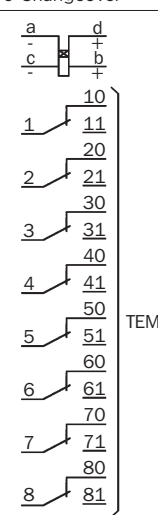
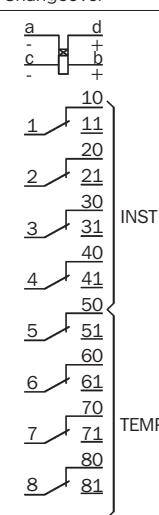
Construction characteristics		
Timing Contacts no.	8 Changeover	4 Changeover
Instantaneous contact no.	0 Changeover	4 Changeover
Connections		
Options		With OP options
Weight (g)		500
Dimensions (mm)		82,5 x 50,4 x 96,6
Coil characteristics		
Standard voltages ⁽¹⁾	24, 48, 72, 96, 110, 125, 250 ⁽⁴⁾ Vdc/Vac (50-60 Hz)	
Voltage range	+25% -30% U _N (except range 250 ⁽⁴⁾ : +10% -20%)	
Pick-up voltage	See power supply-temperature charts for time-lag relays	
Release voltage	See power supply-temperature charts for time-lag relays	
Consumptions Permanencia (U _N)	≤7,5 W	≤10 W
Operating time		
Time Range	between 0,03 s y 99 h	
Pick-up time	<23 ms	
Drop-out time	<40 ms	
Contacts		
Contact type	8 Changeover	
Contact material	AgNi (Gama FF)	
Contact resistance ⁽²⁾	≤30 mΩ / ≤15 mΩ (FF Range)	
Distance between contacts	1,2 mm	
Permanent current	10 A	
Instantaneous current	30 A 0 A during 1s / 80 A during 200 ms / 200 A during 10 ms	
Max. making capacity	40 A / 0,5 s / 110 Vdc 30 A / 1 s / 36 Vdc / 30.000 operations (1 op / 15 s)	
Breaking capacity	See breaking capacity curves (Contact configuration type B)	
Max. breaking capacity	See value for 50,000 operations	
U _{max} opened contact	250 Vdc / 400 Vac	
Performance data		
Mechanical endurance	10 ⁷ operations	
Operating temperature	-40°C +70°C	
Storage temperature	-40°C +70°C	
Max. operating humidity	93% / +40°C	
Operating altitude ⁽²⁾	<2000 m	

⁽¹⁾ Other voltage upon request

⁽²⁾ Guarantee data for relays just manufactured

⁽³⁾ Ask for higher altitudes

⁽⁴⁾ Voltage not recognized by UL

GENERAL PURPOSE LATCHING RELAYS

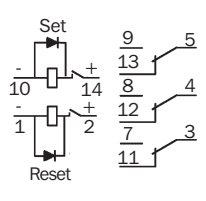
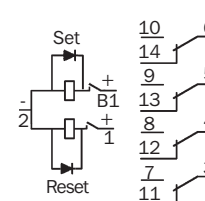
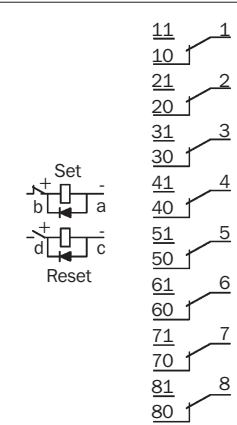
Model	BF-3R	BF-4R	BJ-8R
Applications	Relays with two stable positions. Required when the position memory (open-close, automatic-manual, local-remote...) is needed.		
Construction characteristics			
Contacts no.	3 Changeover	4 Changeover	8 Changeover
Connections			
Options	Options are not available		
Weight (g)	300		600
Dimensions (mm)	45 x 45 x 96,5 (F short Type)		90 x 50 x 100,5 (J short Type)
Coil characteristics			
Standard voltages ⁽¹⁾	24, 48, 72, 110, 125, 220 Vdc / 63,5, 110, 127, 230 Vac (50-60 Hz)		
Voltage range	+25% -30% U _N		
Pick-up voltage	See pick-up voltage / temperature curves for Latching relays		
Consumptions only in the change-over	≤6 W		≤12 W
Operating time			
Pick-up time	<20 ms (Vac)		
Contacts			
Contact material	AgNi		
Distance between contacts	1,8 mm		
Permanent current	10 A		
Instantaneous current	80 A during 200 ms / 200 A during 10 ms		
Max. making capacity	40 A / 0,5 s / 110 Vdc		
Breaking capacity	See breaking capacity curves (Contact configuration type A)		
Max. breaking capacity	See value for 50.000 operations		
U _{max} opened contact	250 Vdc / 400 Vac		
Performance data			
Mechanical endurance	10 ⁷ operations		
Operating temperature	-40°C +70°C		
Storage temperature	-40°C +70°C		
Max. operating humidity	93% / +40°C		
Operating altitude ⁽²⁾	<2000 m		

⁽¹⁾ Other voltage upon request
⁽²⁾ Ask for higher altitudes

TRIP AND LOCKOUT RELAYS (I)

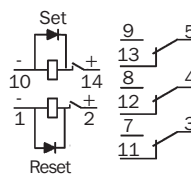
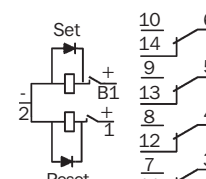
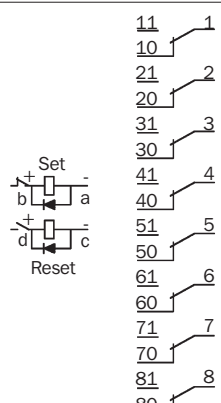
Model	BF-3R	BF-4R	BJ-8R
Applications	Intended for trip and lockout applications where high demanding requirements in operating time and breaking capacity are needed.		
Construction characteristics			
Contacts no.	3 Changeover	4 Changeover	8 Changeover
Connections			
Options	Options are not available		
Weight (g)	300		600
Dimensions (mm)	45 x 45 x 96,5 (F short Type)		90 x 50 x 100,5 (J short Type)
Coil characteristics			
Standard voltages ⁽¹⁾	24, 48, 72, 110, 125, 220 Vdc / 63,5, 110, 127, 230 Vac (50-60 Hz)		
Voltage range	+10% -20% U _N		
Pick-up voltage	See pick-up voltage / temperature curves for Latching relays		
Consumptions only in the change-over	27 W	23 W	35,5 W
Operating time			
Pick-up time	<10 ms (Vdc) <20 ms (Vac)		<10 ms (Vdc) <20 ms (Vac)
Contacts			
Contact material	AgNi		
Distance between contacts	1,8 mm		
Permanent current	10 A		
Instantaneous current	880 A during 200 ms / 200 A during 10 ms		
Max. making capacity	40 A / 0,5 s / 110 Vdc		
Breaking capacity	See breaking capacity curves (Contact configuration type A)		
Max. breaking capacity	See value for 50.000 operations		
U _{max} opened contact	250 Vdc / 400 Vac		
Performance data			
Mechanical endurance	10 ⁷ operations		
Operating temperature	-40°C +70°C		
Storage temperature	-40°C +70°C		
Max. operating humidity	93% / +40°C		
Operating altitude ⁽²⁾	<2000 m		

⁽¹⁾ Other voltage upon request

⁽²⁾ Ask for higher altitudes

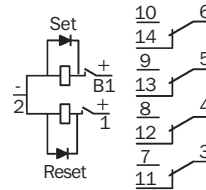
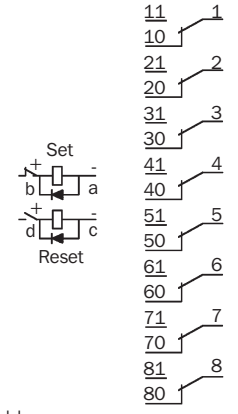

TRIP AND LOCKOUT RELAYS (II)

Model	BF-4RP	BJ-8RP
Applications	Intended for tripping and locking applications where high quality requirements in operating time and breaking capacity are needed, with manual reset.	
Construction characteristics		
Contacts no.	4 Changeover	8 Changeover
Connections		
Options	Options are not available	
Weight (g)	300	600
Dimensions (mm)	45 x 45 x 96,5 (F short Type)	90 x 50 x 100,5 (J short Type)
Coil characteristics		
Standard voltages ⁽¹⁾	24, 48, 72, 110, 125, 220 Vdc 63,5, 110, 127, 230 Vac (50-60 Hz)	
Voltage range	+10% -20% U _N	
Pick-up voltage (20°C)	See pick-up voltage / temperature curves for Latching relays	
Consumptions only in the change-over	23 W	35,5 W
Operating time		
Pick-up time	<10 ms (Vdc) <13 ms (Vac)	<10 ms (Vdc) <20 ms (Vac)
Contacts		
Contact material	AgNi	
Distance between contacts	1,8 mm	
Permanent current	10 A	
Instantaneous current	80 A during 200 ms / 200 A during 10 ms	
Max. making capacity	40 A / 0,5 s / 110 Vdc	
Breaking capacity	See breaking capacity curves (Contact configuration type A)	
Max. breaking capacity	See value for 50,000 operations	
U _{max} opened contact	250 Vdc / 400 Vac	
Performance data		
Mechanical endurance	10 ⁷ operations	
Operating temperature	-40°C +70°C	
Storage temperature	-40°C +70°C	
Max. operating humidity	93% / +40°C	
Operating altitude ⁽²⁾	<2000 m	

⁽¹⁾ Other voltage upon request

⁽²⁾ Ask for higher altitudes

LATCHING RELAYS WITH COIL OVERVOLTAGE PROTECTION

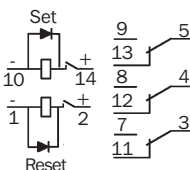
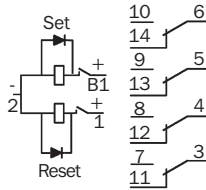
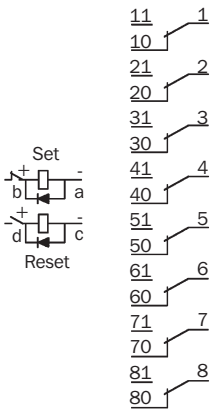
Model	BF-3BB	BF-4BB	BJ-8BB
			
Applications	Intended to protect the contact of the equipment that feeds the coil in our relay.		
Construction characteristics			
Contacts no.	3 Changeover	4 Changeover	8 Changeover
Connections			
Options	Options are not available		
Weight (g)	300		600
Dimensions (mm)	45 x 45 x 96,5 (F large Type)		90 x 50 x 100,5 (J large Type)
Coil characteristics			
Standard voltages ⁽¹⁾	24, 48, 72, 110, 125, 220 Vdc ⁽³⁾		
Voltage range	+25% -30% U _N		
Pick-up voltage	See pick-up voltage / temperature curves for Latching relays		
Consumptions only in the change-over	≤6 W		≤12 W
Operating time			
Pick-up time	<20 ms		
Contacts			
Contact material	AgNi		
Distance between contacts	1,8 mm		
Permanent current	10 A		
Instantaneous current	80 A during 200 ms / 200 A during 10 ms		
Max. making capacity	40 A / 0,5 s / 110 Vdc		
Breaking capacity	See breaking capacity curves (Contact configuration type A)		
Max. breaking capacity	See value for 50,000 operations		
U _{max} opened contact	250 Vdc / 400 Vac		
Performance data			
Mechanical endurance	10 ⁷ operations		
Operating temperature	-40°C +70°C		
Storage temperature	-40°C +70°C		
Max. operating humidity	93% / +40°C		
Operating altitude ⁽²⁾	<2000 m		

⁽¹⁾ Other voltage upon request

⁽²⁾ Ask for higher altitudes

⁽³⁾ Vac voltages upon request

BREAKING CAPACITY



› With devices operating worldwide, also heavy industries like oil & gas sector trust in our relays.

BREAKING CAPACITY

The breaking capacity is a critical parameter on the design and the applications of the relays. Its mechanical life could be considerably reduced, depending on the value of the load (especially with heavy duty loads), the number of operations and the environmental conditions in which the relay is operating.

In any configuration, ARTECHE's auxiliary relays have a high breaking capacity values. These limits are showed in the table below, in terms of power and current values. In all the cases, these relays guarantee a right performance during 50,000 operations.

Likewise, the values showed in the following charts have been obtained in standard conditions in the laboratory, and they could be different in real conditions. In any case, the possibility of connecting serial contacts or a bigger distance between contacts makes these values to be considerably increased.

24 Vdc voltage Different loads configurations.

Resistive load:

› L/R= 0 ms.

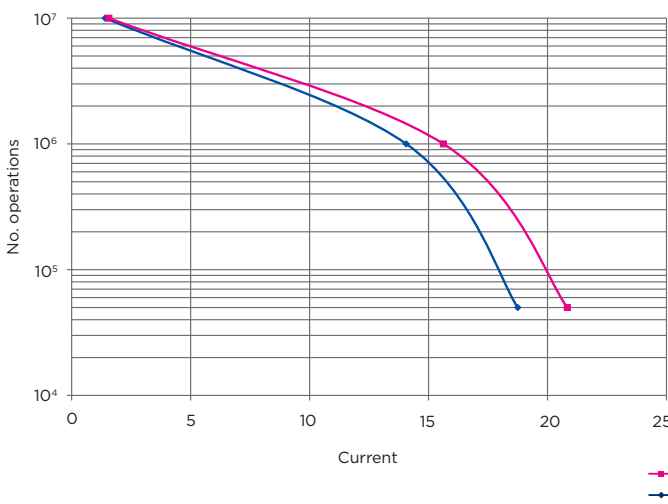

Highly inductive load:

› L/R= 40 ms.

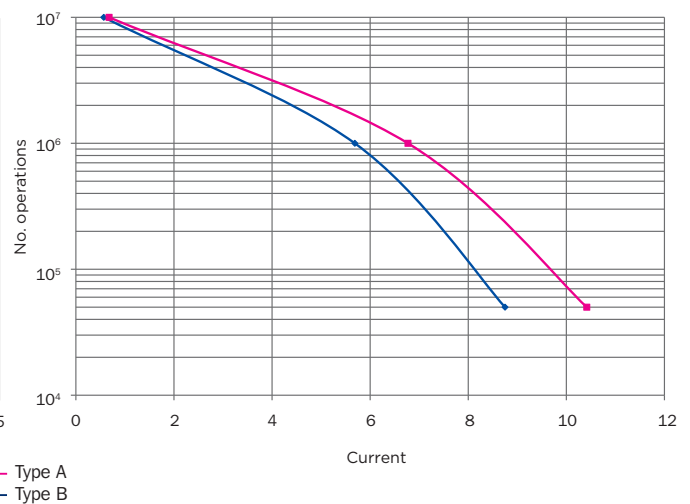

Vdc	Contact configuration	0 ms		20 ms		40 ms	
		P(W)	I(A)	P(W)	I(A)	P(W)	I(A)
24	Type A	500	20,83	370	15,42	250	10,42
	Type B	450	18,75	300	12,50	210	8,75

110 Vdc voltage Different loads configurations.

Resistive load:

> L/R= 0 ms.

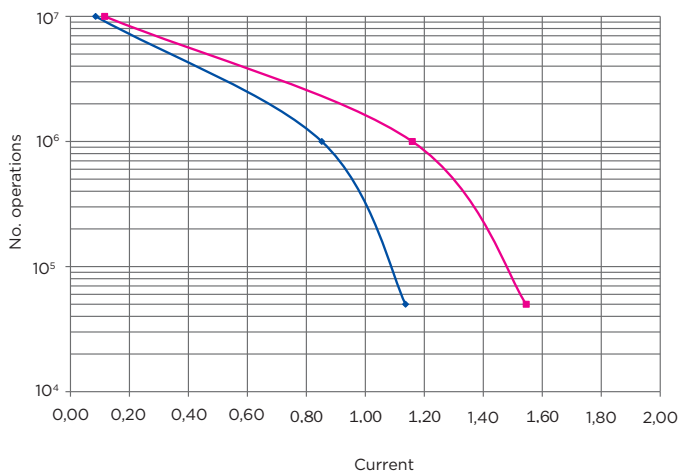

Highly inductive load:

> L/R= 40 ms.

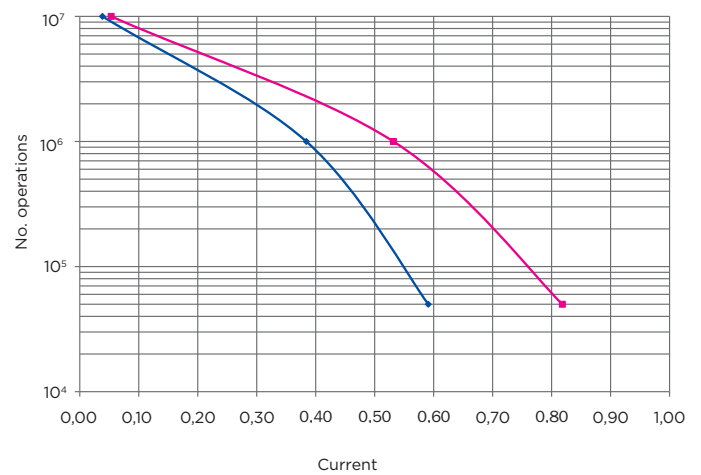

—■— Tipo A
—●— Tipo B

Vdc	Contacts configuration	0 ms		20 ms		40 ms	
		P(W)	I(A)	P(W)	I(A)	P(W)	I(A)
110	Type A	170	1,55	140	1,27	90	0,82
	Type B	125	1,14	100	0,91	65	0,59

220 Vdc voltage Different loads configurations.

Resistive load:

› L/R= 0 ms.

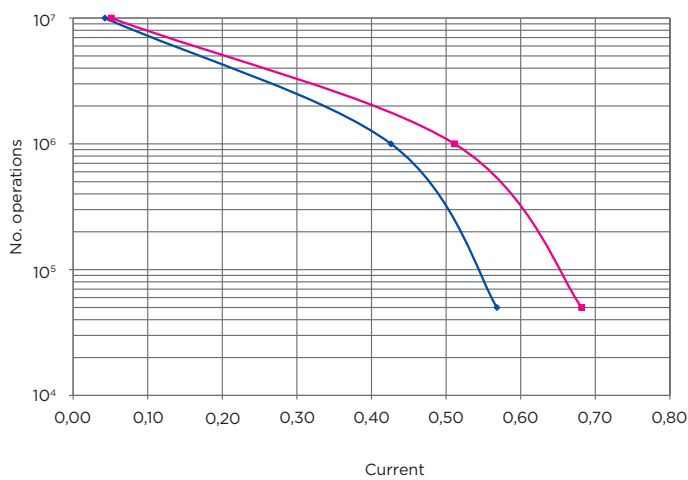

Highly inductive load:

› L/R= 40 ms.

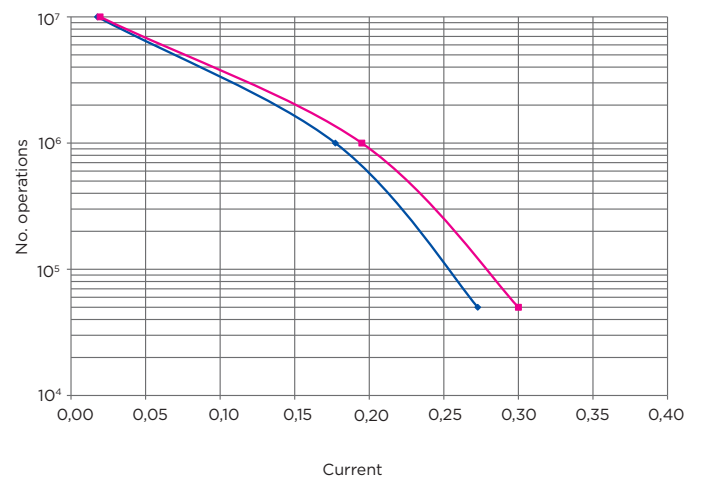

— Tipo A
— Tipo B

Vdc	Contacts configuration	0 ms		20 ms		40 ms	
		P(W)	I(A)	P(W)	I(A)	P(W)	I(A)
220	Type A	150	0,68	115	0,52	66	0,30
	Type B	125	0,57	104	0,47	60	0,27

HOW TO SELECT THE CURVE OF MY RELAY

These charts show the breaking capacity values, either for resistive and highly inductive loads, in three voltage values of reference (ask for other voltage values). The charts show two different curves:

- › Type A: Breaking capacity of the relays with distance between contacts = 1.8 mm.
- › Type B: Breaking capacity of the relays with distance between contacts = 1.2 mm.

The distance between contacts is shown in the tables of technical data.

HOW THE BREAKING CAPACITY CAN BE INCREASED

ARTECHE's auxiliary relays are power relays, designed specially to have a high breaking capacity. Thus, there are applications where the loads are so high that it is necessary to even increase the breaking capacity, keeping the reliability of the contacts of the auxiliary relays.

Thus, ARTECHE relays have the following alternatives and recommendations:

- › Possibility of external connection of equipment (serial contacts) getting an important increase of breaking capacity in these equipment is shown, guaranteeing the right performance during a high number of operations.
- › Include the magnetic blow-out option: This option is indicated for safety applications (back-up) where the load values are extremely high. The mechanical life of the relay is reduced, but it is able to open very high loads for a certain number of operations.

These values of high breaking capacity are represented in the following table, where the high capacity of the output contacts of ARTECHE's auxiliary relays is proved:



Relay	I	V	L/R
With contact configuration Type A + magnetic blow out (OP: 1XXXX)	5 A	125 Vdc	40 ms
With contact configuration Type B + magnetic blow out (OP: 1XXXX)			



arteche



Arteche has more than 100 customer service technical points, an expert engineers network close to you everywhere

PICK-UP VOLTAGE/RELEASE VOLTAGE-TEMPERATURE CHARTS

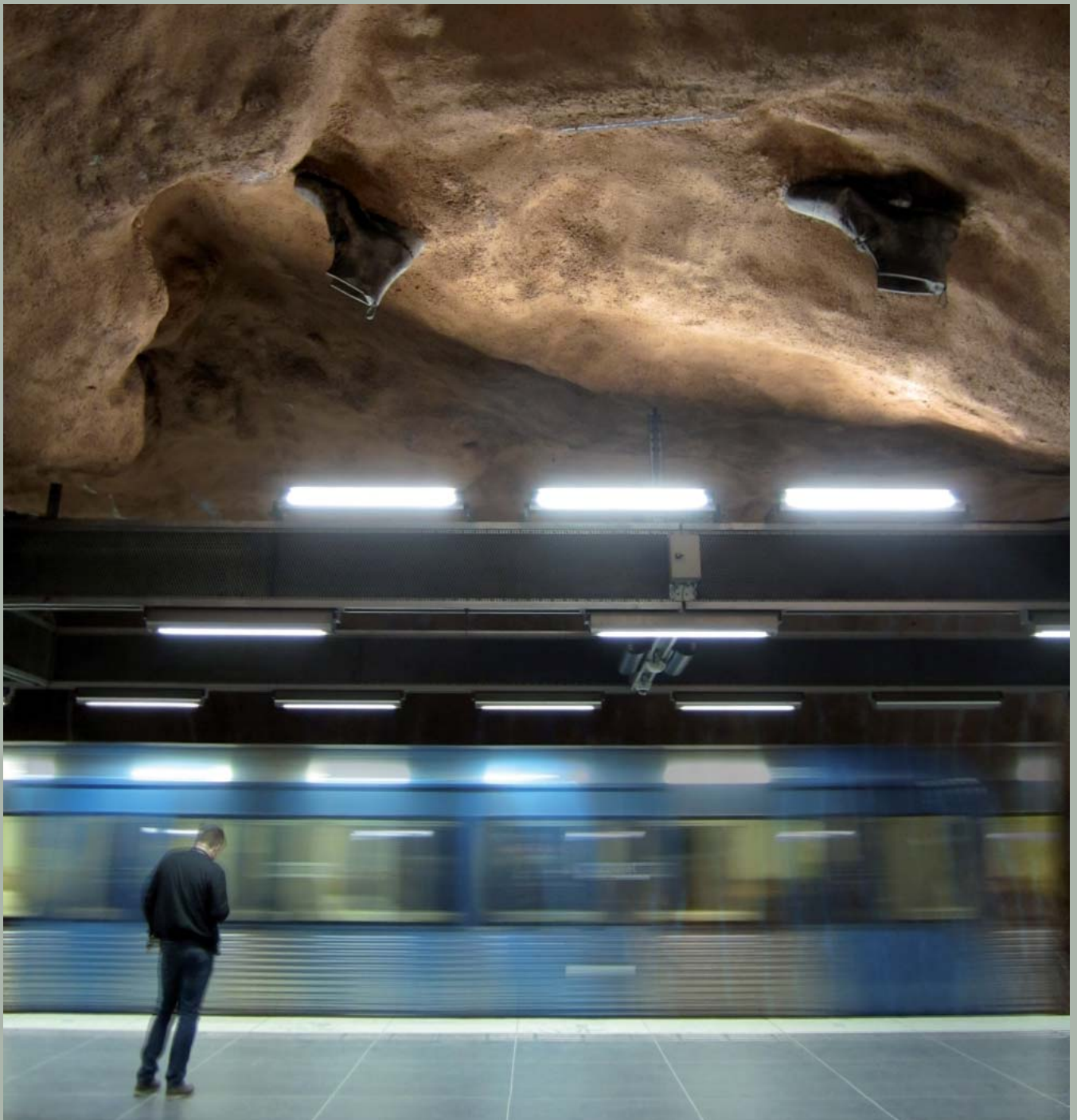

INSTANTANEOUS RELAYS

Variability of operative voltage range against temperature for the instantaneous auxiliary relays.

GENERAL PURPOSE RELAYS AND RELAYS WITH COIL OVERVOLTAGE PROTECTION

Operative range against ambient temperature

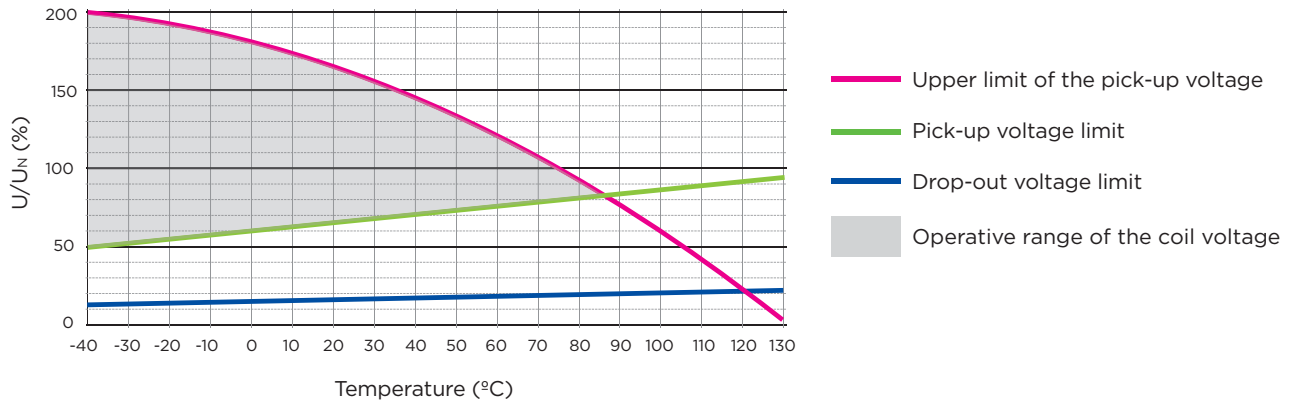

TRIPPING RELAYS

Operative range against ambient temperature

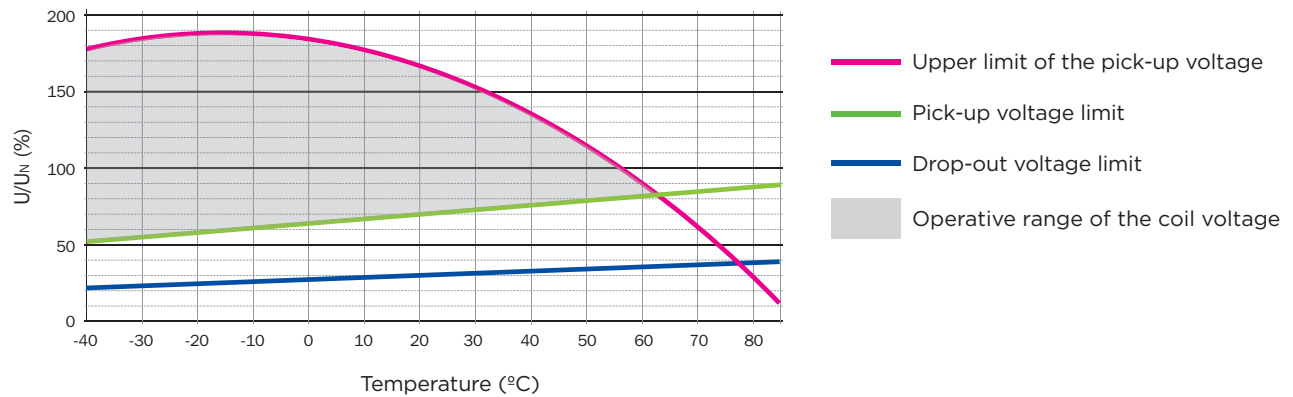

INSTANTANEOUS RELAYS WITH SEISMIC CHARACTERISTICS

Operative range against ambient temperature

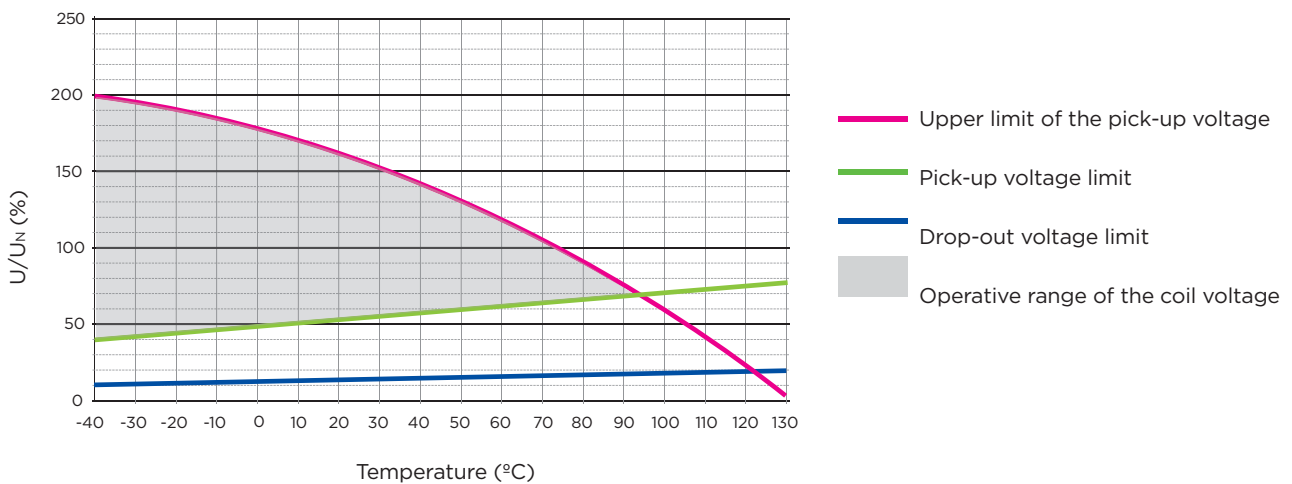

LATCHING RELAYS

Variability of operative voltage range against temperature for the Latching relays.

LATCHING PURPOSE RELAYS AND RELAYS WITH COIL OVERVOLTAGE PROTECTION

Operative range against ambient temperature

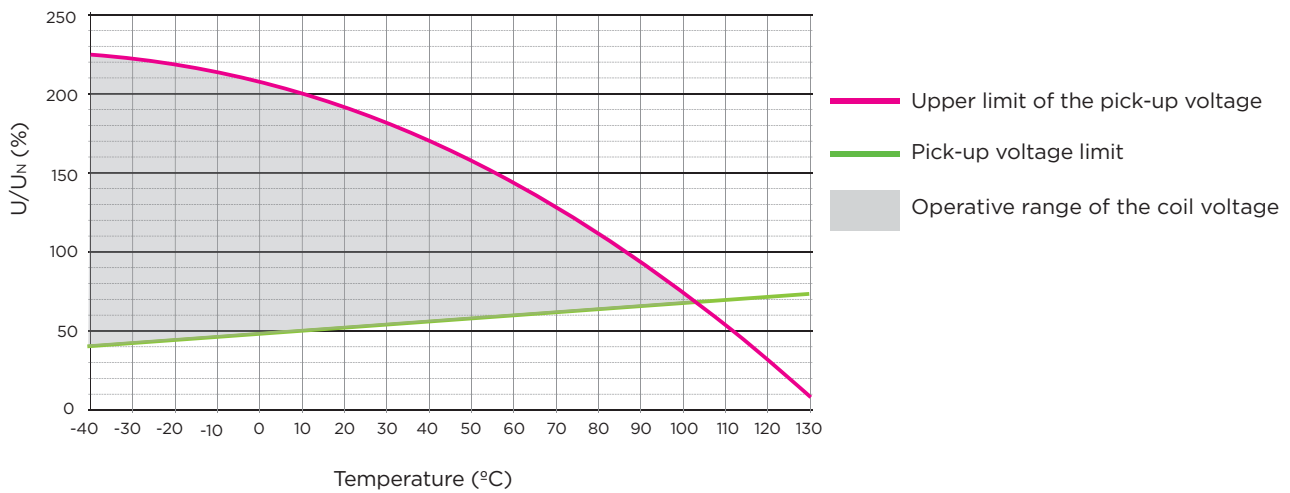

TRIP AND LOCKOUT RELAY

Operative range against ambient temperature

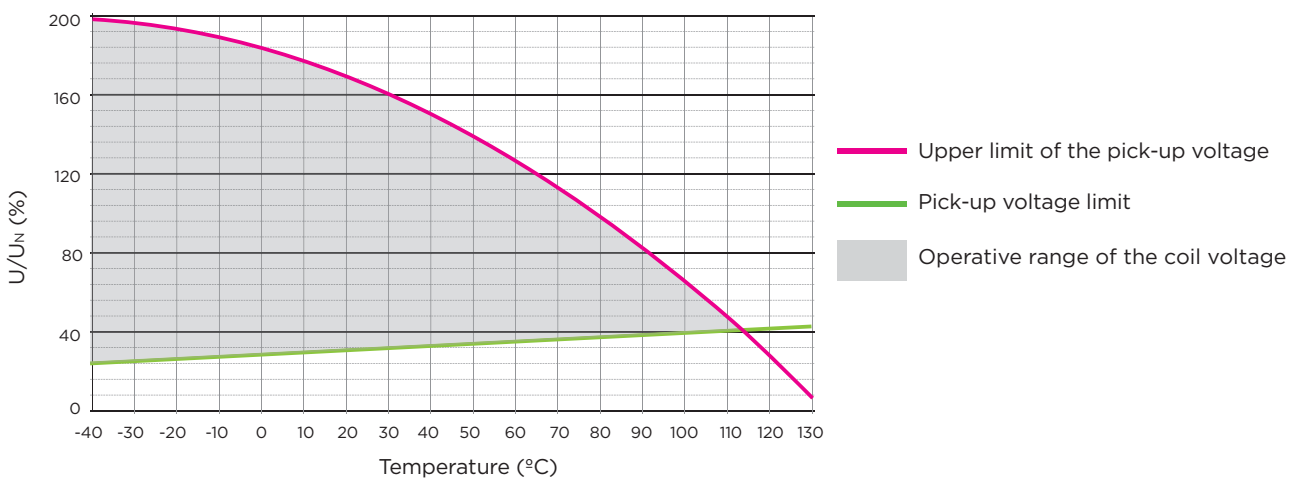

TRIP AND LOCKOUT RELAY WITH RESET PUSH BUTTON

Operative range against ambient temperature

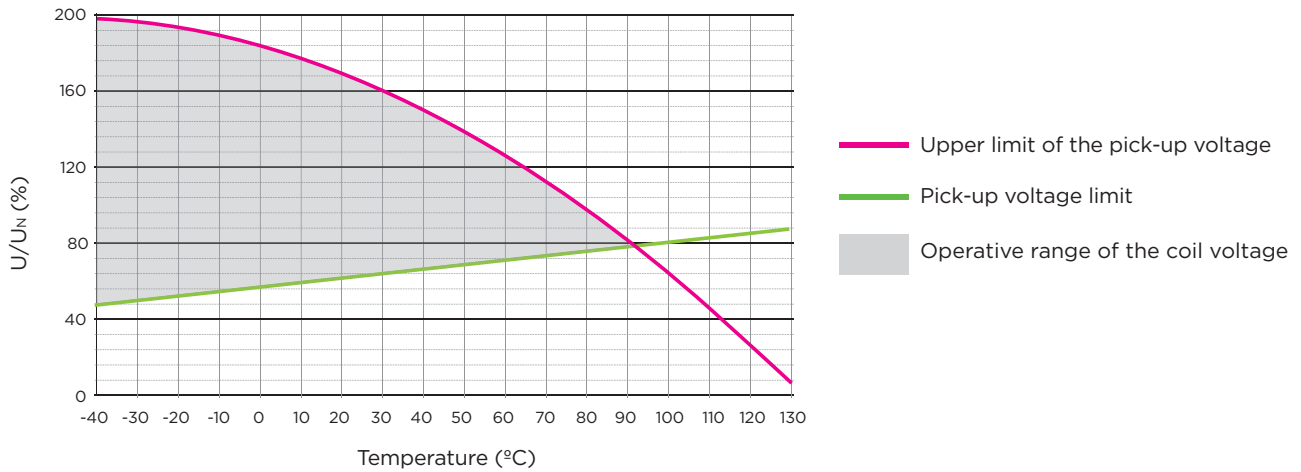

TIME-LAG RELAYS

Variability of operative voltage range against temperature for the time-lag relays.

RELÉS TEMPORIZADOS

Operative range against ambient temperature

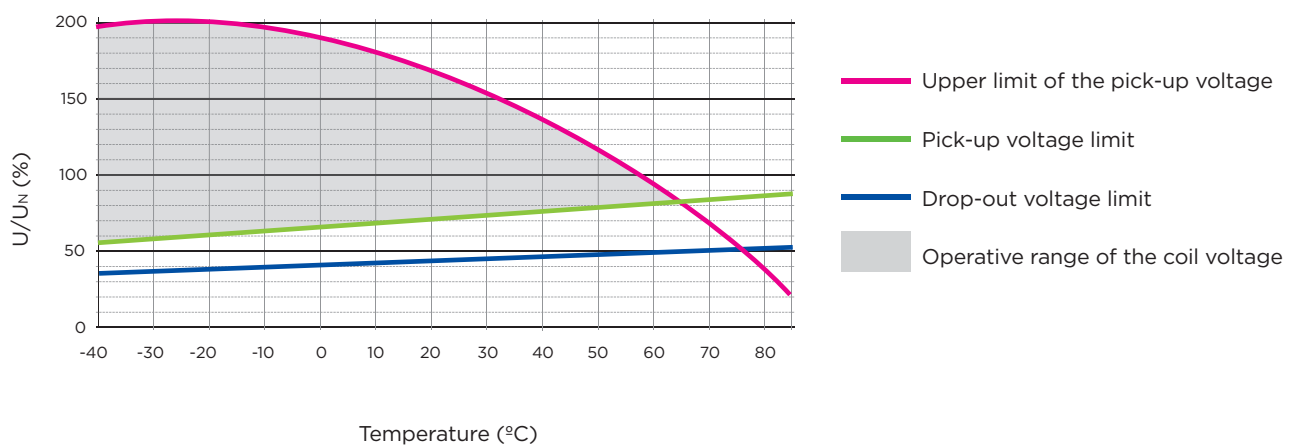

MODELS SELECTION

Instantaneous	Type	Range	Range FF(*)	Aux. Supply Vdc or Vac.	Options													
					OP													
General purpose range																		
2 contacts relay	RD-2																	1
4 contacts relay	RF-4																	1
8 contacts relay	RJ-8																	1
Tripping relays range																		
Fast		R									1							
Extra-fast (Vdc only)		XR									1							
Seismic characteristics range																		
Seismic		SY																
With coil overvoltage protection range																		
Diode in parallel with the coil (only Vdc)		DI																
Varistance in parallel with the coil		V																
With seismic characteristics and coil overvoltage protection range																		
Seismic with diode in parallel with the coil (only Vdc)		SYDI																
Seismic with diode in parallel with the coil		SYV																
Range																		
	No		-															
	Yes		FF															
Aux. Supply Vdc o Vac																		
Indicate voltage level and if it is VDC or VAC (ex: 24 VDC)																		
Options																		
High breaking capacity (magnetic arc blow-out)	No										0							
	Yes										1							
Front LED	No											0						
	Yes											1						
Mechanical contact position indicator	No												0					
	Yes												1					
Trip flag	No													0				
	Yes													1				
Push to test button	No																	0
	To push the contacts																	1
	Fix the contacts																	2

Restrictions

(*) Indicate just if FF range is required

Latching	Type	Range	Range FF(**)	Aux. Supply Vdc or Vac.
General purpose range				
3 contacts relay	BF-3			
4 contacts relay	BF-4			
8 contacts relay	BJ-8			
Options				
Diode in parallel with the coil (only Vdc)		BB		
Trip relay (only Vdc)		R		
Fast-acting with reset push button (*)		RP		
Range FF				
	No		-	
	Yes		FF	
Aux. Supply Vdc o Vac				
Indicate voltage level and if it is VDC or VAC (ex: 24 VDC)				

(*) Unavailable for 3 contacts (**) Indicate just if FF range is required

Timers	Type	Range FF(**)	Aux. Supply Vdc or Vac.	Options
General purpose range				OP
Relay with 2 timer contacts	TDF-2			
Relay with 4 timer contact	TDF-4			
Relay with 2 instantaneous contacts + 2 timer contacts	TDF-22			
Relay with 8 timer contacts	TDJ-8			
Relay with 4 instantaneous contacts + 4 timer contacts	TDJ-44			
Range FF				
	No		-	
	Yes		FF	
Aux. Supply Vdc o Vac				
Indicate voltage level and if it is VDC or VAC (ex: 24 VDC)				
Options				
High Breaking Capacity (magnetic arc blow-out)	No			0
	Yes			1
	Dependent			0
		24 Vdc • Vac		1
		48 Vdc • Vac		2
		60 Vdc • Vac		3
Command sign voltage	Independent	72 Vdc • Vac		4
		96 Vdc • Vac		5
		110 Vdc • Vac		6
		125 Vdc • Vac		7
		220 Vdc • Vac		8

Restrictions

(*) Indicate just if FF range is required

DIMENSIONS OF THE RELAYS

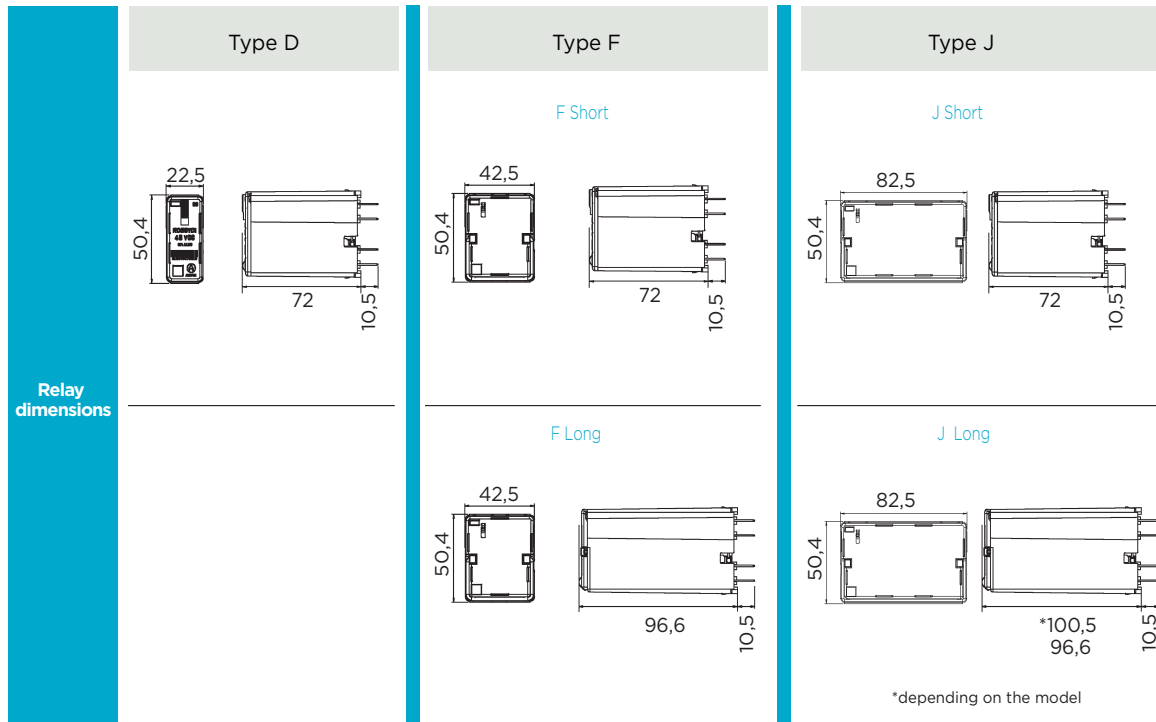

SOCKETS: DIMENSIONS AND CUT-OUT

Sockets		Accessories		Weight (g)
Relay	Type	Screw	Double faston	
D	TIP10 Front connection	DN-DE IP10 FF	DN-DE2C IP10 FF	60
	IP20 Front connection	DN-DE IP20 FF	DN-DE2C IP20 FF	60
	Rear connection	DN-TR OP FF	DN-TR2C OP FF	50
F	IP10 Front connection	FN-DE IP10 FF	FN-DE2C IP10 FF	110
	IP20 Front connection	FN-DE IP20 FF	FN-DE2C IP20 FF	110
	IP20 Rear connection	FN-TR OP FF	FN-TR2C OP FF	90
	IP20 Flush mounting	F-EMP OP FF		300
J	IP10 Front connection	JN-DE IP10 FF	JN-DE2C IP10 FF	225
	IP20 Front connection	JN-DE IP20 FF	JN-DE2C IP20 FF	225
	IP20 Rear connection	JN-TR OP FF	JN-TR2C OP FF	180
	IP20 Flush mounting	J-EMP OP FF		400

Accessories
Retaining clips
Function signs on the extraction ring
Security pins (*)

(*) Not available for latching relays

	Relays type D	Relays type F	Relays type J
Sockets for DIN rail (1) (2)	DN-DE IP10 FF • DN-DE2C IP10 FF 	FN-DE IP10 FF • FN-DE2C IP10 FF 	JN-DE IP10 FF • JN-DE2C IP10 FF
	DN-DE IP20 FF • DN-DE2C IP20 FF 	FN-DE IP20 FF • FN-DE2C IP20 FF 	JN-DE IP20 FF • JN-DE2C IP20 FF
Sockets for rear connection	DN-TR OP FF • DN-TR2C OP FF 	FN-TR OP FF • FN-TR2C OP FF 	JN-TR OP FF • JN-TR2C OP FF
Sockets for flush mounting		F-EMP OP FF • F-EMP (short) OP FF 	J-EMP OP FF • J-EMP (short) OP FF
		F-EMP OP FF • F-EMP (long) OP FF 	J-EMP OP FF • J-EMP (long) OP FF
Cut-out			



⁽¹⁾ DIN rail according to EN50022

⁽²⁾ Minimum distance between sockets will depend on type of relay and sockets. Please request sockets user manual for more detailed information.

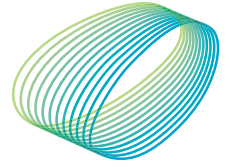

arteche

MOVING TOGETHER

Updates: ARTECHE_CT_Auxiliary-Relays-Railway Sector_E
Version: A1