

# Servo solenoid valves with on-board electronics (OBE)

**RE 29035/01.05**  
Replaces 11.03

1/12

## Type 4WRPEH 6

Size 6  
Unit series 2X  
Maximum working pressure P, A, B 315 bar, T 250 bar  
Nominal flow rate 2...40 l/min ( $\Delta p$  70 bar)



## List of contents

Contents	Page
Features	1
Ordering data and scope of delivery	2
Preferred types	2
Function, sectional diagram	3
Symbols	3
Technical data	4 to 6
On-board trigger electronics	7 and 8
Performance curves	9 and 10
Unit dimensions	11

## Features

- Directly operated servo solenoid valve NG6, with control piston and sleeve in servo quality
- Actuated on one side, 4/4 fail-safe position when switched off
- Control solenoid with integral position feedback and on-board electronics (OBE), calibrated at the factory
- Electrical connection 6P+PE  
Signal input difference amplifier with interface A1  $\pm 10$  V, or interface F1 4...20 mA ( $R_S$  200  $\Omega$ )
- Suitable for electrohydraulic controllers in production and testing systems
- For subplate attachment, mounting hole configuration to ISO 4401-03-02-0-94
- Subplates as per catalogue section RE 45053 (order separately)
- Line sockets to DIN 43563-AM6, see catalogue section RE 08008 (order separately)

## Variants on request

- For standard applications
- Special symbols for plastic machines
- Possible valve electronics with 11P+PE line socket and extension of module.

Ordering data and scope of delivery

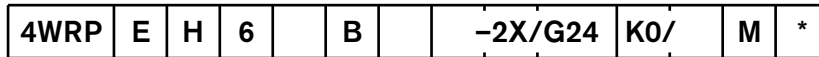

With on-board trigger electronics = E  
 Control piston/sleeve = H  
 Size 6 = 6

Symbols

4/4-way version

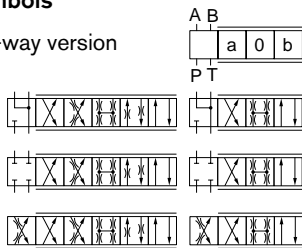

With symbols C5 and C1: <sup>3)</sup>

P → A:  $q_v$       B → T:  $q_v/2$   
 P → B:  $q_v/2$     A → T:  $q_v$

Side of inductive position transducer

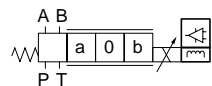

(Standard) = B

- <sup>1)</sup> Only in connection with flow characteristic "p"
- <sup>2)</sup> Kink 60% for NG6 with nominal flow rate "15" and "25", otherwise kink 40
- <sup>3)</sup>  $q_v$  2:1 only with nominal flow rate = 40 l/min

Further information in plain text

M = NBR seals, suitable for mineral oils (HL, HLP) to DIN 51524

Interface for trigger electronics

A1 = Setpoint input ±10 V  
 F1 = Setpoint input 4...20 mA

Electrical connection

K0 = without line socket, with plug to DIN 43563-AM6  
 Order line socket separately

Voltage supply of trigger electronics

G24 = +24 V DC

2X = Unit series 20 to 29 (installation and connection dimensions unchanged)

Flow characteristic

L = Linear  
 P = Non-linear curve<sup>2)</sup>

Nominal flow rate at 70 bar valve pressure difference (35 bar/metering notch)

Size 6				
02 = 2 l/min	12 = 12 l/min	24 = 24 l/min	40 <sup>3)</sup> = 40 l/min	
04 = 4 l/min	15 <sup>1)</sup> = 15 l/min	25 <sup>1)</sup> = 25 l/min		

Preferred types (available at short notice)

Type 4WRPEH 6	Material No.
<b>C3 / C5</b>	
4WRPEH 6 C3B02L -2X/G24K0 / A1M	0 811 404 744
4WRPEH 6 C3B04L -2X/G24K0 / A1M	0 811 404 600
4WRPEH 6 C3B12L -2X/G24K0 / A1M	0 811 404 601
4WRPEH 6 C3B24L -2X/G24K0 / A1M	0 811 404 602
4WRPEH 6 C3B40L -2X/G24K0 / A1M	0 811 404 603
4WRPEH 6 C5B40L -2X/G24K0 / A1M	0 811 404 746
4WRPEH 6 C3B15P -2X/G24K0 / A1M	0 811 404 642
4WRPEH 6 C3B25P -2X/G24K0 / A1M	0 811 404 643
4WRPEH 6 C3B40P -2X/G24K0 / A1M	0 811 404 644
4WRPEH 6 C5B40P -2X/G24K0 / A1M	0 811 404 648
4WRPEH 6 C3B04L -2X/G24K0 / F1M	0 811 404 631
4WRPEH 6 C3B12L -2X/G24K0 / F1M	0 811 404 632
4WRPEH 6 C3B24L -2X/G24K0 / F1M	0 811 404 633
4WRPEH 6 C3B40L -2X/G24K0 / F1M	0 811 404 634
4WRPEH 6 C5B40L -2X/G24K0 / F1M	0 811 404 749

Type 4WRPEH 6	Material No.
<b>C1 / C4</b>	
4WRPEH 6 C4B02L -2X/G24K0 / A1M	0 811 404 641
4WRPEH 6 C4B04L -2X/G24K0 / A1M	0 811 404 610
4WRPEH 6 C4B12L -2X/G24K0 / A1M	0 811 404 611
4WRPEH 6 C4B24L -2X/G24K0 / A1M	0 811 404 612
4WRPEH 6 C4B40L -2X/G24K0 / A1M	0 811 404 613
4WRPEH 6 C1B40L -2X/G24K0 / A1M	0 811 404 738
4WRPEH 6 C4B15P -2X/G24K0 / A1M	0 811 404 645
4WRPEH 6 C4B25P -2X/G24K0 / A1M	0 811 404 646
4WRPEH 6 C4B40P -2X/G24K0 / A1M	0 811 404 647
4WRPEH 6 C1B40P -2X/G24K0 / A1M	0 811 404 649
4WRPEH 6 C4B04L -2X/G24K0 / F1M	0 811 404 350
4WRPEH 6 C4B12L -2X/G24K0 / F1M	0 811 404 351
4WRPEH 6 C4B24L -2X/G24K0 / F1M	0 811 404 352
4WRPEH 6 C4B40L -2X/G24K0 / F1M	0 811 404 353
4WRPEH 6 C1B40L -2X/G24K0 / F1M	0 811 404 354
<b>C..</b>	
4WRPEH 6 C B04L -2X/G24K0 / A1M	0 811 404 741
4WRPEH 6 C B24L -2X/G24K0 / A1M	0 811 404 355
4WRPEH 6 C B40L -2X/G24K0 / A1M	0 811 404 639
4WRPEH 6 C B40L -2X/G24K0 / F1M	0 811 404 640

Function, sectional diagram

Servo solenoid valve 4WRPEH 6

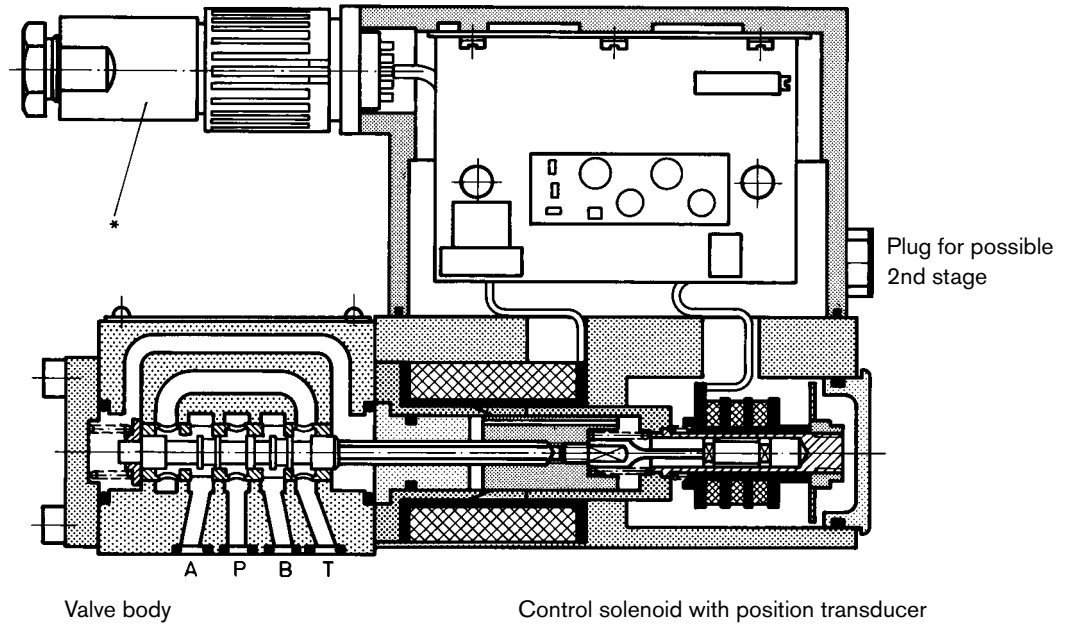
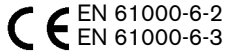

Symbols

	Linear	p: kink 60% [ $q_n$ 15,25 l/min]	p: kink 40% [ $q_n$ 40 l/min]
	C3, C5, C4, C1, C	Standard = 1:1, from $q_n$ 40 l/min also 2:1	

Accessories, not included in scope of delivery

(4x)  M5x30 DIN 912-10.9	Fastening screws	2910151166
	Line sockets 6P+PE, see also RE 08008	KS 1834482022 KS 1834482026 MS 1834482023 MS 1834482024 KS 90° 1834484252

Testing and service equipment



- Test box type VT-PE-TB3, see RE 30065
- Test adapter 6P+PE type VT-PA-2, see RE 30068

## Technical data

### General

Construction	Spool type valve, operated directly, with steel sleeve					
Actuation	Proportional solenoid with position control, OBE					
Type of mounting	Subplate, mounting hole configuration NG6 (ISO 4401-03-02-0-94)					
Installation position	Optional					
Ambient temperature range	°C	-20 ... +50				
Weight	kg	2.7				
Vibration resistance, test condition	max. 25 g, shaken in 3 dimensions (24 h)					

### Hydraulic (measured with HLP 46, $\vartheta_{oil} = 40^\circ\text{C} \pm 5^\circ\text{C}$ )

Pressure fluid	Hydraulic oil to DIN 51524 ... 535, other fluids after prior consultation							
Viscosity range	recommended	mm <sup>2</sup> /s	20 ... 100					
	max. permitted	mm <sup>2</sup> /s	10 ... 800					
Pressure fluid temperature range	°C	-20 ... +70						
Maximum permissible degree of contamination of pressure fluid Purity class to ISO 4406 (c)	Class 18/16/13 <sup>1)</sup>							
Flow direction	See symbol							
Nominal flow at $\Delta p = 35$ bar per notch <sup>2)</sup>	l/min	2	4	12	15	24	40	
Max. working pressure	bar	Port P, A, B: 315						
Max. pressure	bar	Port T: 250						
Operating limits at $\Delta p$ Pressure drop at valve		bar	315	315	315	315	315	160
$q_{Vnom} > q_N$ valves		bar	315	315	315	280	250	100
Leakage at 100 bar		cm <sup>3</sup> /min	<150	<180	<300	-	<500	<900
		cm <sup>3</sup> /min	-	-	-	<180	<300	<450

### Static/Dynamic

Hysteresis	%	$\leq 0.2$
Manufacturing tolerance for $q_{max}$	%	< 10
Response time for signal change 0 ... 100%	ms	$\leq 10$
Thermal drift	Zero point displacement <1 % at $\Delta T = 40^\circ\text{C}$	
Zero adjustment	Factory-set $\pm 1\%$	
Conformity	 EN 61000-6-2 EN 61000-6-3	

<sup>1)</sup> The purity classes stated for the components must be complied with in hydraulic systems. Effective filtration prevents problems and also extends the service life of components. For a selection of filters, see catalogue sections RE 50070, RE 50076 and RE 50081.

<sup>2)</sup> Flow rate at a different  $\Delta p$   $q_x = q_{nom} \cdot \sqrt{\frac{\Delta p_x}{35}}$

## Technical data

### Electrical, trigger electronics integrated in the valve

Cyclic duration factor	%	100
Degree of protection		IP 65 to DIN 40050 and IEC 14434/5
Connection		Line socket 6P+PE, DIN 43563
Power supply		24 DC <sub>nom</sub>
Terminal A:		min. 21 V DC/max. 40 V DC
Terminal B: 0 V		Ripple max. 2 V DC
Power consumption		Solenoid $\square$ 45 mm = 40 VA max.
External fuse		2.5 A <sub>F</sub>
Input, "Standard" version		Difference amplifier, $R_i = 100 \text{ k}\Omega$
Terminal D: $U_E$		0 ... $\pm 10 \text{ V}$
Terminal E:		0 V
Input, "mA-Signal" version		Burden, $R_{sh} = 200 \Omega$
Terminal D: $I_{D-E}$		4 ... (12) ... 20 mA
Terminal E: $I_{D-E}$		Current loop $I_{D-E}$ feedback
Max. differential input voltage at 0 V		$D \rightarrow B$ } max. 18 DC $E \rightarrow B$ }
Test signal, "Standard" version		LVDT
Terminal F: $U_{\text{Test}}$		0 ... +10 V
Terminal C:		Reference 0 V
Test signal, "mA-Signal" version		LVDT signal 4 ... 20 mA at external load 200 ... 500 $\Omega$ max.
Terminal F: $I_{F-C}$		4 ... 20 mA output
Terminal C: $I_{F-C}$		Current loop $I_{F-C}$ feedback
Protective conductor and screen		See pin assignment (installation conforms to CE)
Recommended cable		See pin assignment up to 20 m 7x0.75 mm <sup>2</sup> up to 40 m 7x1 mm <sup>2</sup>
Calibration		Calibrated at the factory, see valve performance curve

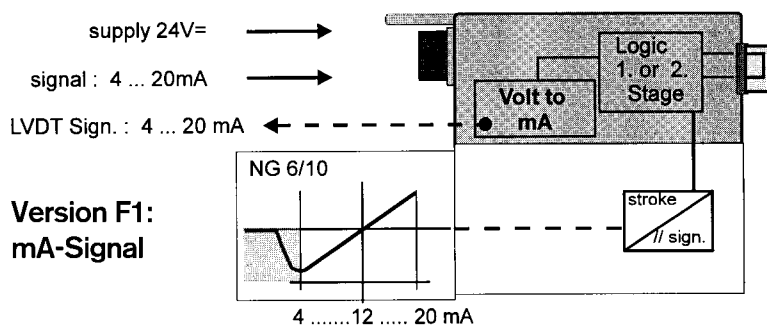
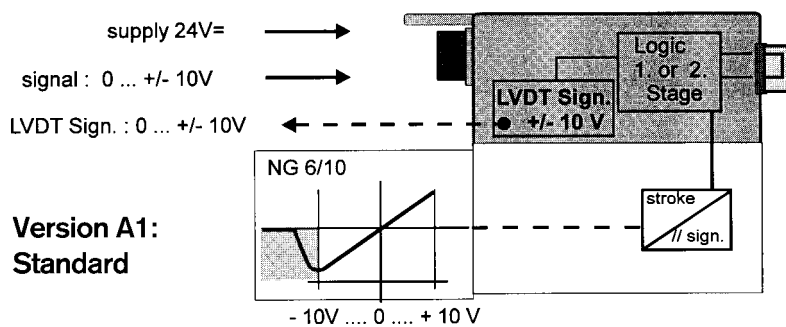

## Connection

For electrical data, see page 5 and  
Operating Instructions 1 819 929 083

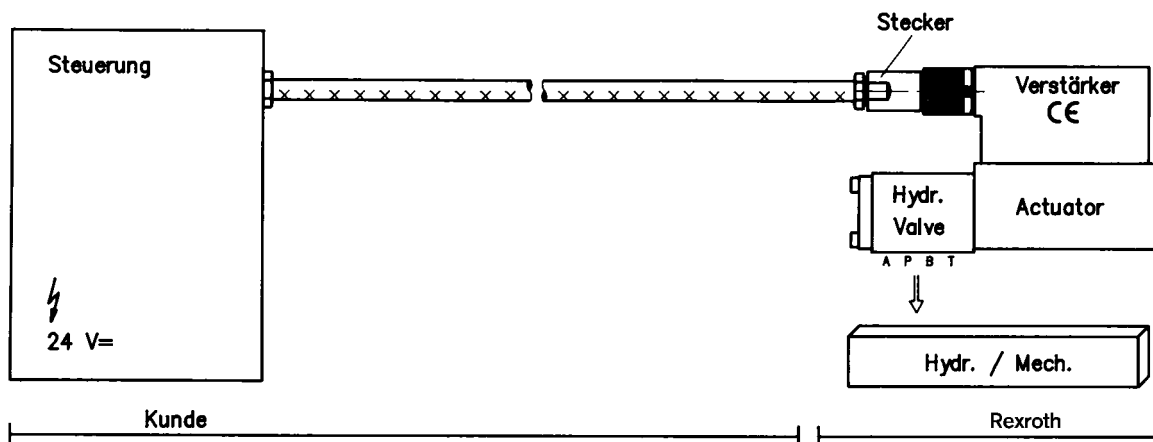

### Technical notes on the cable

- Version:**
- Multi-wire cable
  - Extra-finely stranded wire to VDE 0295, Class 6
  - Protective conductor, green/yellow
  - Cu braided screen
- Types:**
- e.g. Ölflex-FD 855 CP (from Lappkabel company)
- No. of wires:**
- Determined by type of valve, plug types and signal assignment
- Cable Ø:**
- 0.75 mm<sup>2</sup> up to 20 m length
  - 1.0 mm<sup>2</sup> up to 40 m length
- Outside Ø:**
- 9.4... 11.8 mm – Pg11
  - 12.7... 13.5 mm – Pg16

### Note

Voltage supply 24 V DC nom., if voltage drops below 18 V DC, rapid shutdown resembling “Enable OFF” takes place internally.

In addition, with the “mA signal” version:

$I_{D-E} \geq 3 \text{ mA}$  – valve is active

$I_{D-E} \leq 2 \text{ mA}$  – valve is deactivated.

Electrical signals emitted via the trigger electronics (e.g. actual values) must not be used to shut down safety-relevant machine functions! (See European Standard, “Technical Safety Requirements for Fluid-Powered Systems and Components – Hydraulics”, EN 982).

### On-board trigger electronics

#### Block diagram/pin assignment

Version A1:  $U_{D-E} \pm 10V$

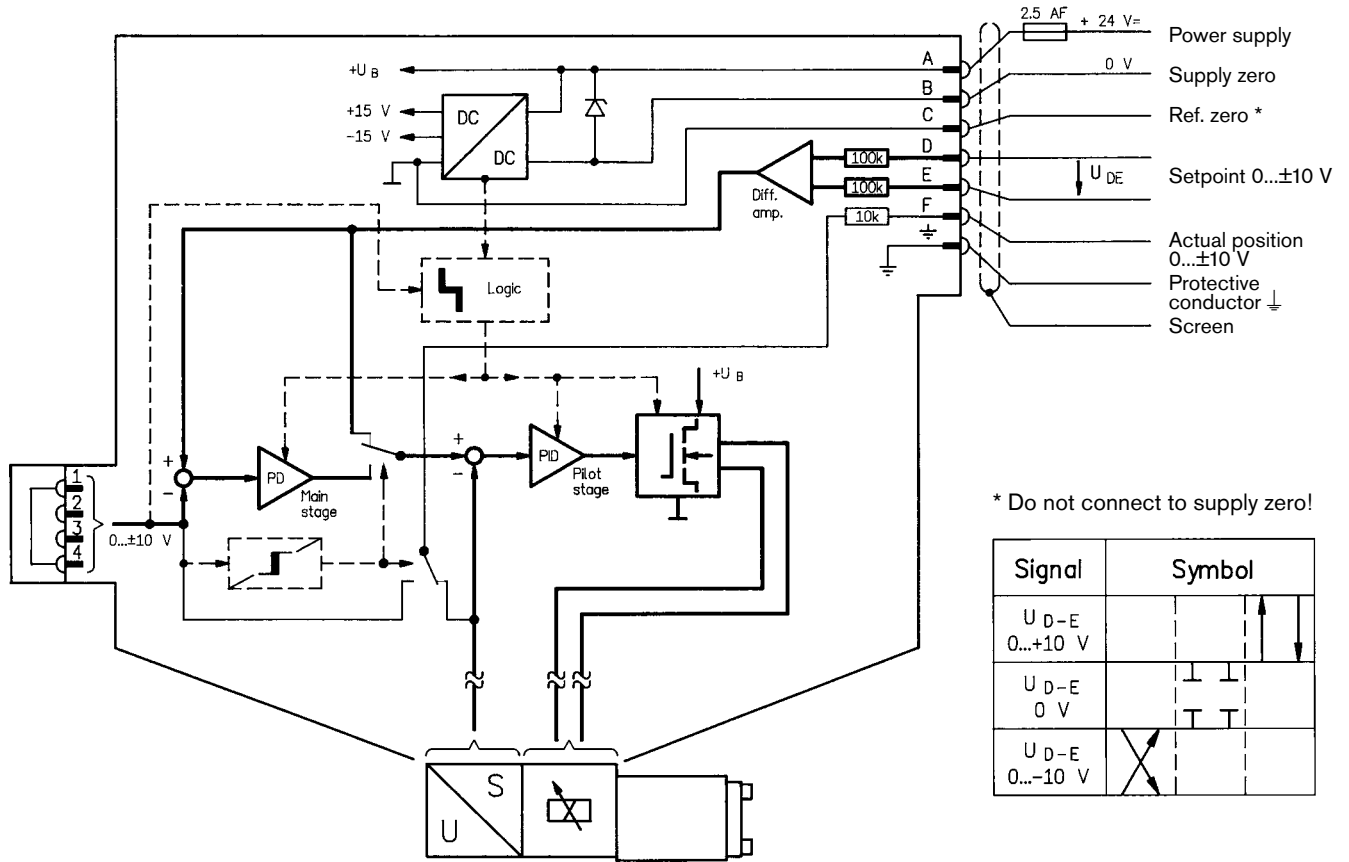

#### Pin assignment 6P + PE

Version A1:  $U_{D-E} \pm 10 V$

( $R_i = 100 k\Omega$ )

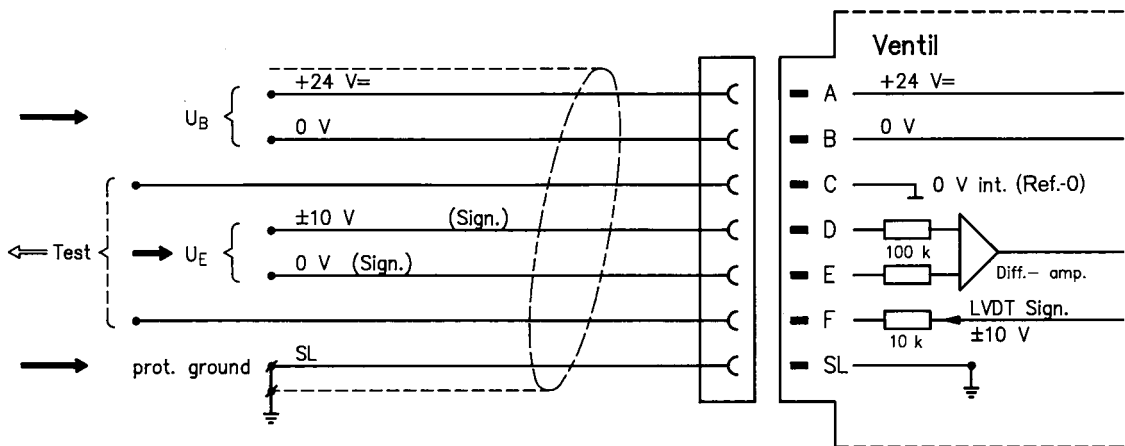

### On-board trigger electronics

#### Block diagram/pin assignment

Version F1:  $I_{D-E}$  4...12...20 mA

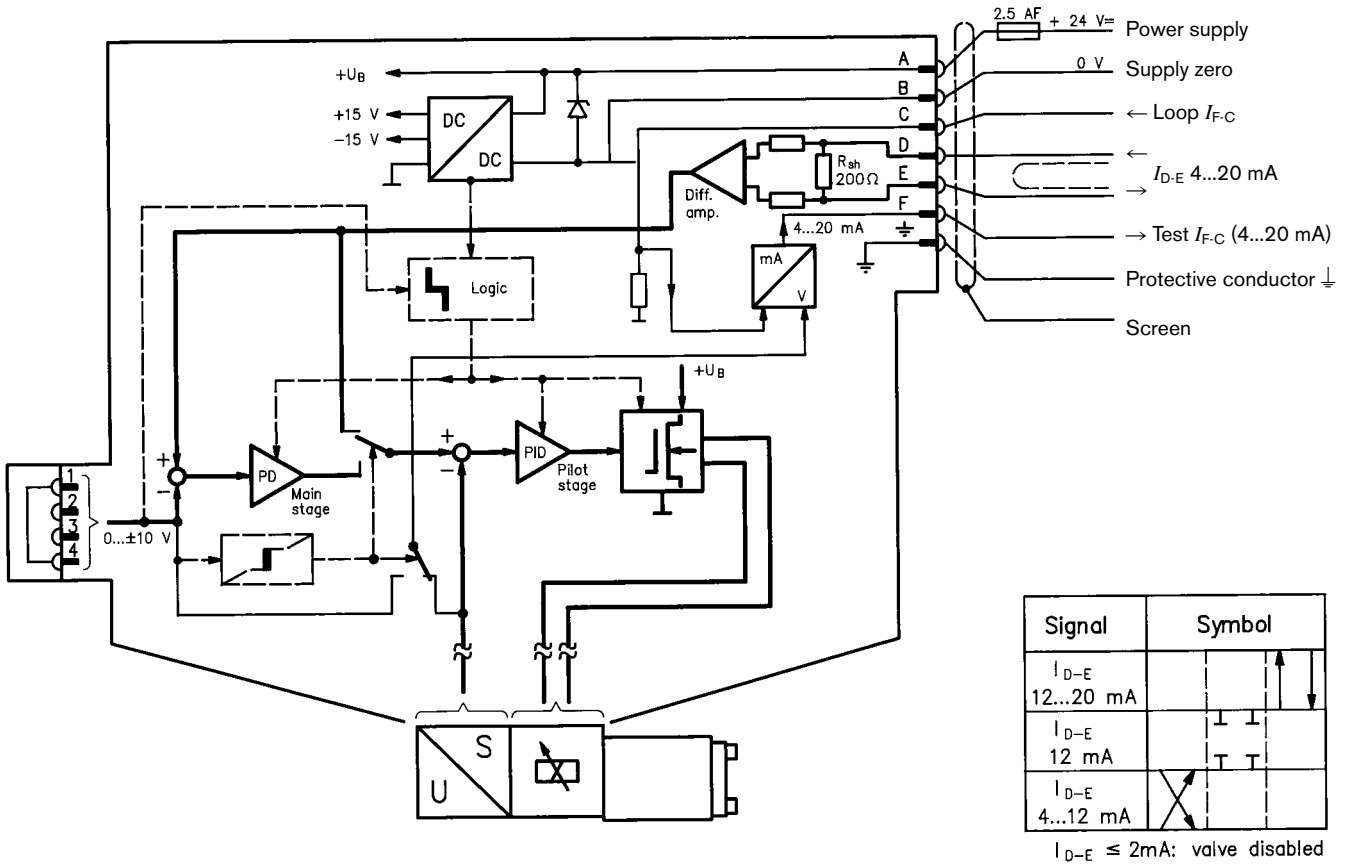

#### Pin assignment 6P + PE

Version F1:  $I_{D-E}$  4...12...20 mA

( $R_{sh} = 200 \Omega$ )

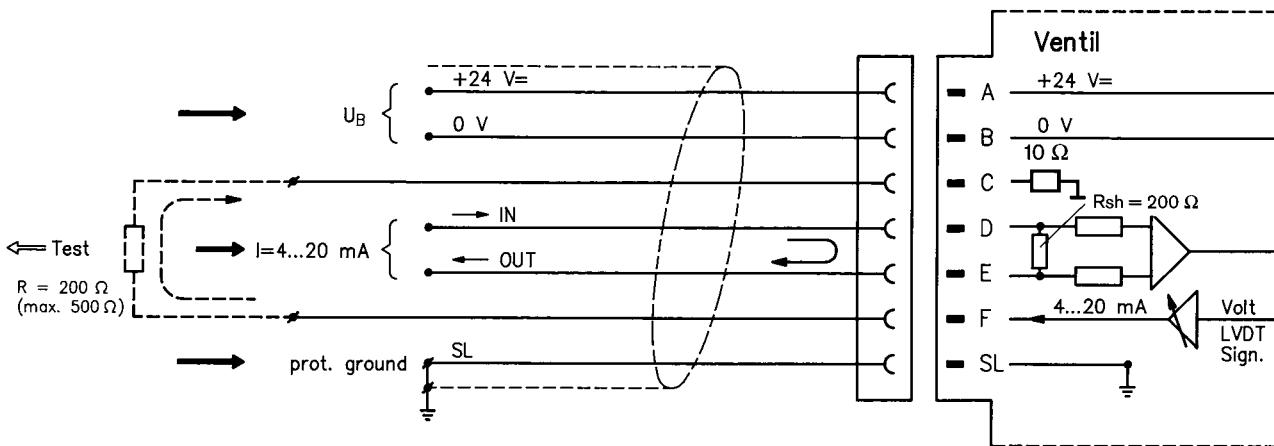



**Performance curves** (measured with HLP46,  $\vartheta_{oil} = 40^\circ\text{C} \pm 5^\circ\text{C}$ )

Flow rate/Signal function  $Q = f(U_{D-E})$   
 $Q = f(I_{D-E})$

L: Linear

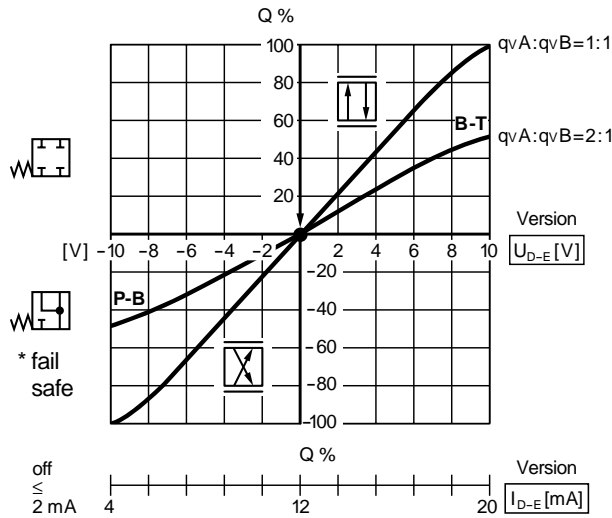

P: (kink 60%)

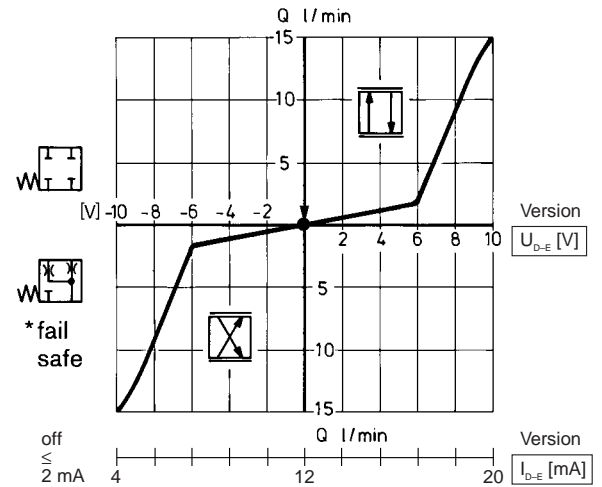

P: (kink 60%)

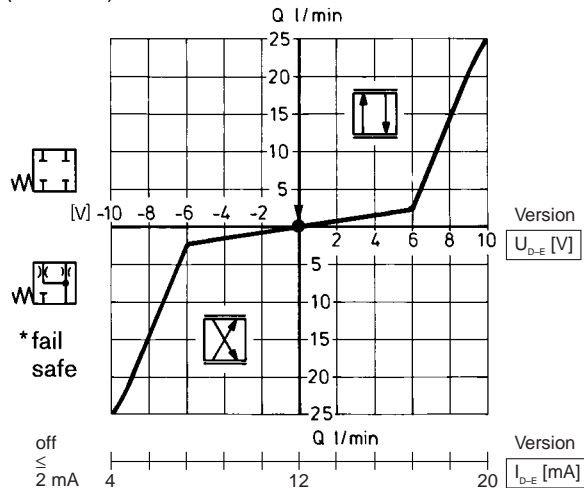

P: (kink 40%)

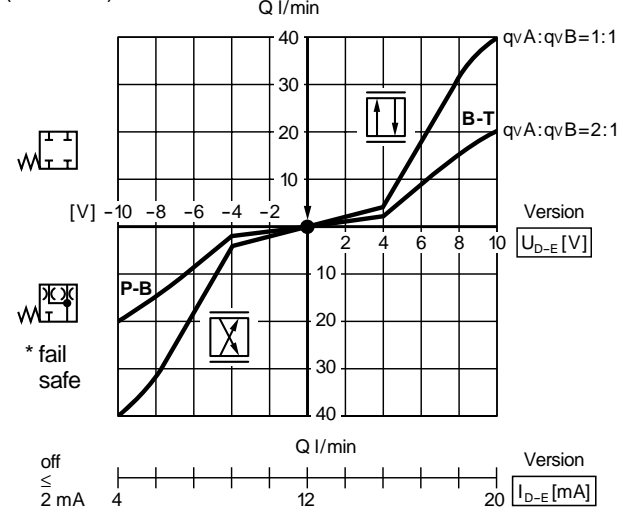

\* Fail-safe:  $U_B \leq 18\text{ V DC}$   
(version  $U_{D-E}$ )

\* Fail-safe:  $U_B \leq 18\text{ V DC} / I_{D-E} \leq 2\text{ mA}$   
(version  $I_{D-E} 4 \dots 20\text{ mA}$ )

Calibrated  $\pm 1\%$

Fail-safe-Position			
	Leakage at	100 bar	P-A 50 cm <sup>3</sup> /min P-B 70 cm <sup>3</sup> /min
	Flow rate at	$\Delta p = 35\text{ bar}$	A-T 10 ... 20 l/min B-T 7 ... 20 l/min
	Leakage at	100 bar	P-A 50 cm <sup>3</sup> /min P-B 70 cm <sup>3</sup> /min A-T 70 cm <sup>3</sup> /min B-T 50 cm <sup>3</sup> /min
		Fail-safe $p = 0\text{ bar} \rightarrow 7\text{ ms}$ $p = 100\text{ bar} \rightarrow 10\text{ ms}$	Internal enable off $U_B \leq 18\text{ V DC}$ $(I_{D-E} \leq 2\text{ mA})$

Performances curves (measured with HLP 46,  $\vartheta_{oil} = 40^\circ\text{C} \pm 5^\circ\text{C}$ )

Pressure gain

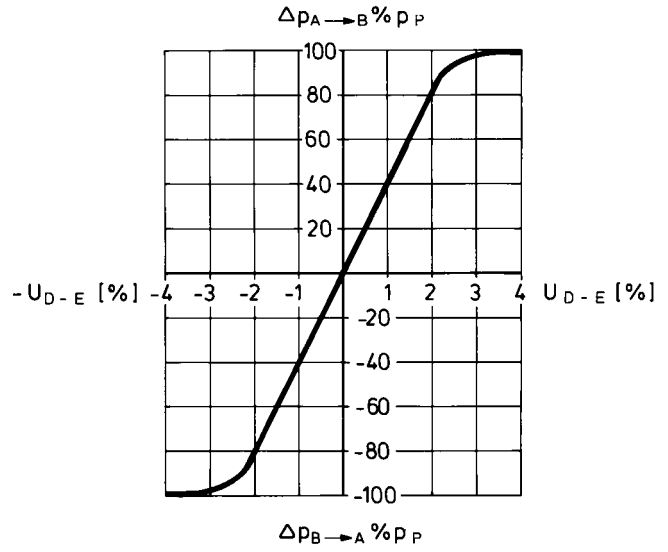
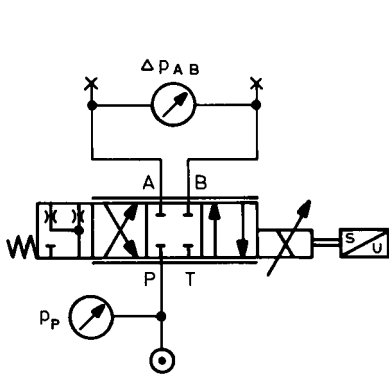

Bode diagram

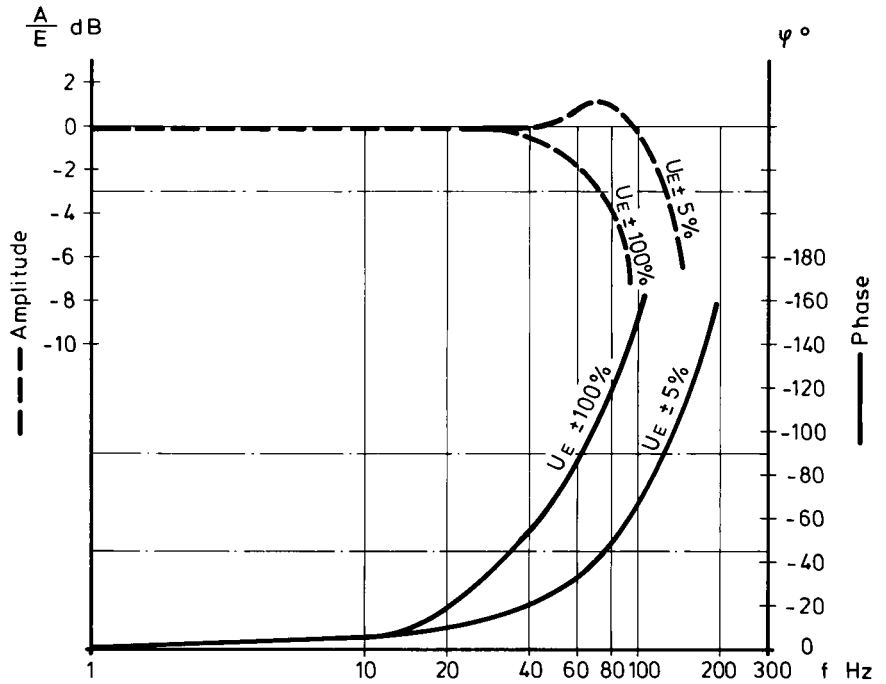
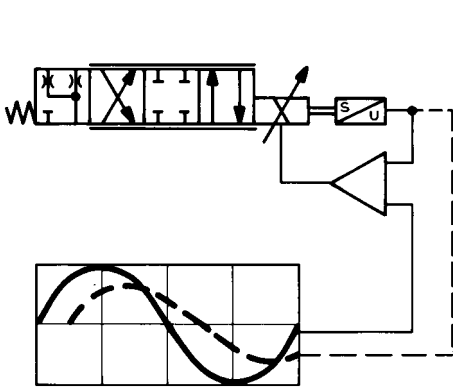

**Unit dimensions** (Nominal dimensions in mm)

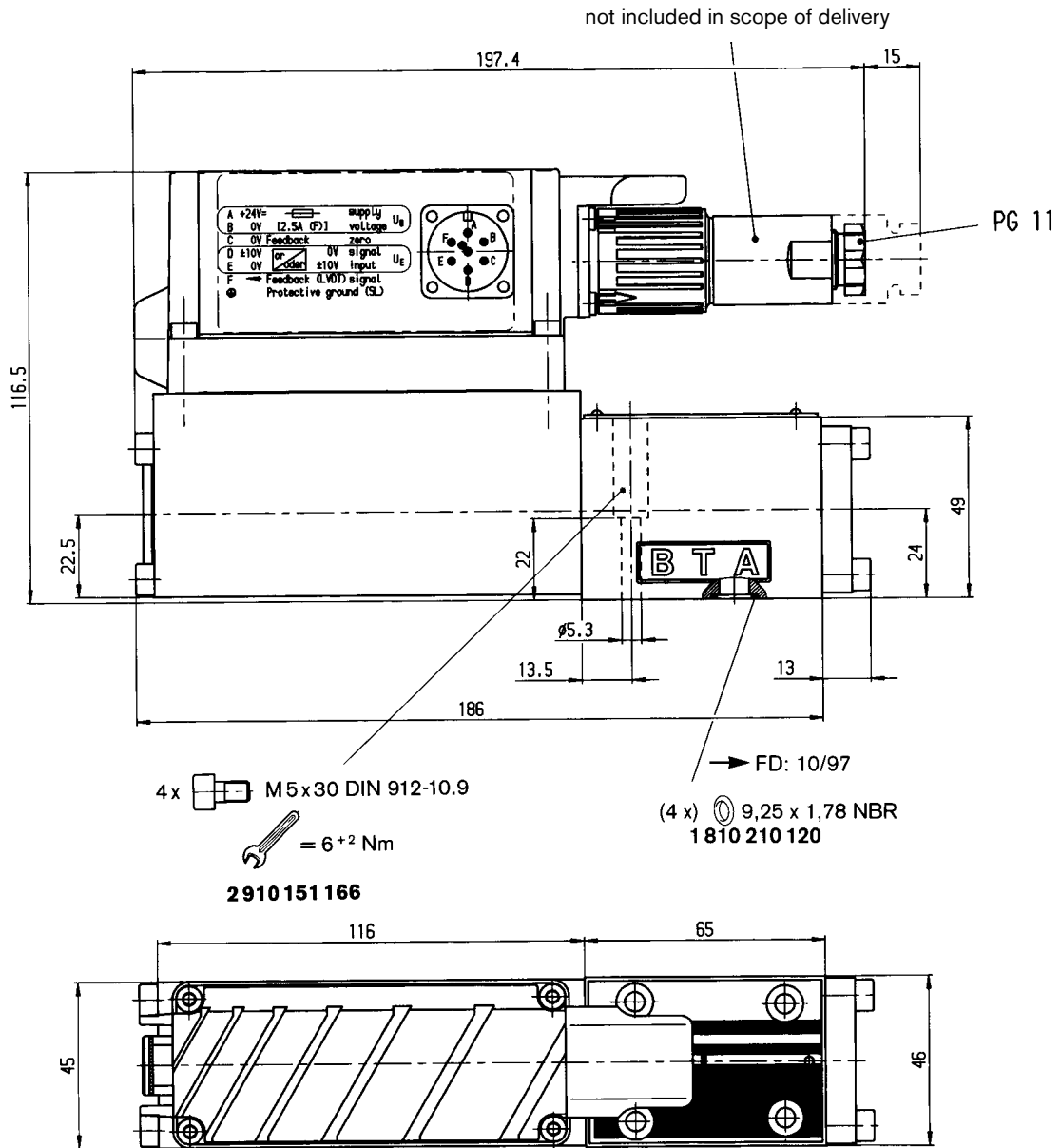

Required surface quality of mating component

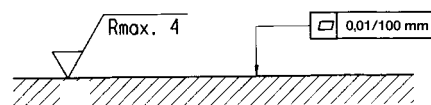

**Mounting hole configuration: NG6**

(ISO 4401-03-02-0-94)

For subplates, see catalogue section RE 45053

<sup>1)</sup> Deviates from standard

<sup>2)</sup> Thread depth:

Ferrous metal 1.5xØ

Non-ferrous 2 xØ

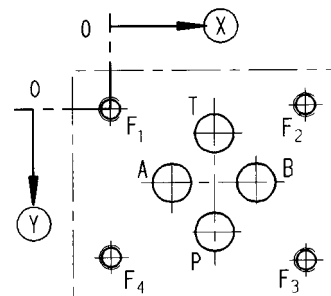

	P	A	T	B	F <sub>1</sub>	F <sub>2</sub>	F <sub>3</sub>	F <sub>4</sub>
⊗	21.5	12.5	21.5	30.2	0	40.5	40.5	0
⊙	25.9	15.5	5.1	15.5	0	-0.75	31.75	31
∅	8 <sup>1)</sup>	8 <sup>1)</sup>	8 <sup>1)</sup>	8 <sup>1)</sup>	M5 <sup>2)</sup>	M5 <sup>2)</sup>	M5 <sup>2)</sup>	M5 <sup>2)</sup>

## Notes

---