

**E47 Precision Limit Switches**

**The Cost-Effective Solution for Highly Accurate Switching Applications**

**Contents**

Overview ..... 1  
 Model Selection,  
 Basic Switches ..... 2  
 Model Selection,  
 Accessories ..... 5  
 Model Selection,  
 Enclosed Switches ..... 5  
 Specifications ..... 7

Cutler-Hammer® E47 Precision Switches from Eaton’s electrical business provide high accuracy switching at an affordable price. A variety of standard features, such as current capacity, operating force, travel characteristics and actuators, lets you custom fit the switch to your application.

The switches are available in their compact basic form, or enclosed in a rugged, metal housing.

**Approvals**

- UL Recognized
- CSA Certified



**Unless otherwise noted, the products contained in this document are not designed or intended for use in human safety applications.**

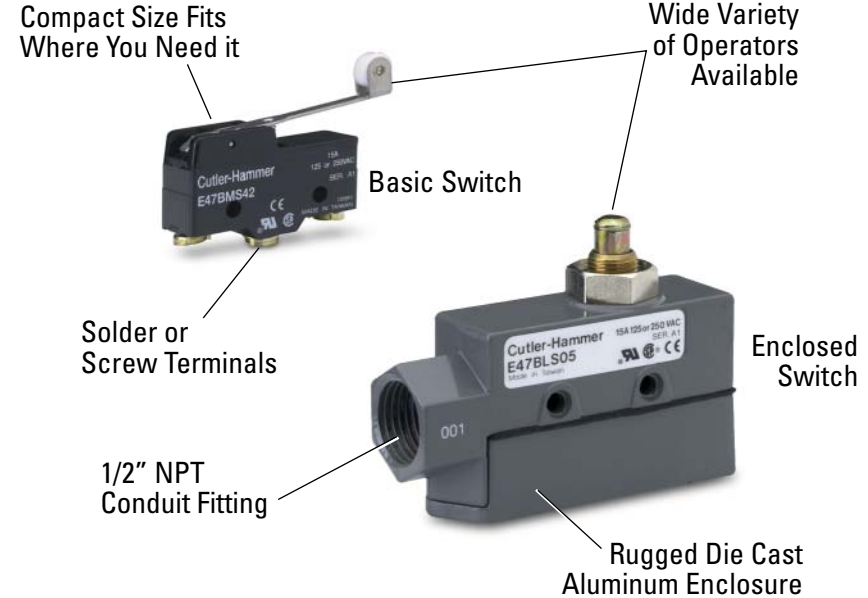

**Product Features**

- Compact housings are ideal for use where space is restricted
- Precision, snap-action operators provide accurate repeatability of electrical and mechanical operating characteristics
- High current capacity (up to 20A) allows power load switching and motor handling capability
- Enclosed booted versions shield actuators from debris



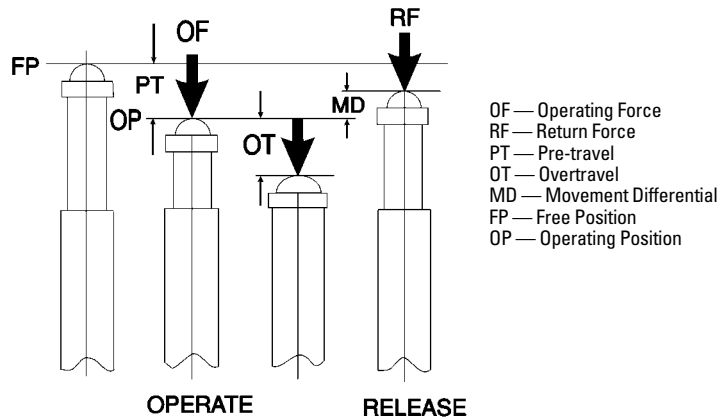





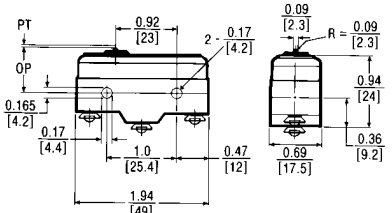

**Definitions — Operating Characteristics**

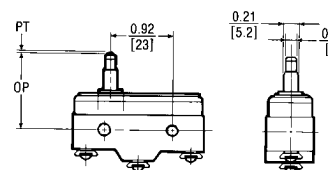

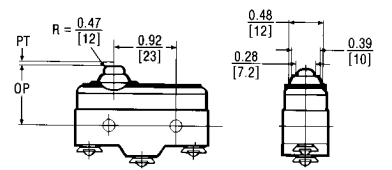
For Customer Service in the U.S. call **1-800-356-1243**,  
 in Canada call **1-800-268-3578**.  
 For Application Assistance in the U.S. and Canada  
 call **1-800-426-9184**.

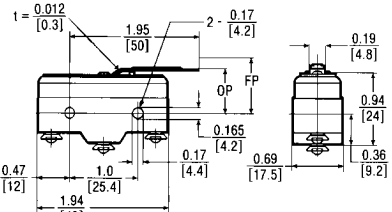
July 2005

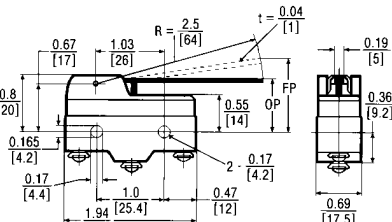

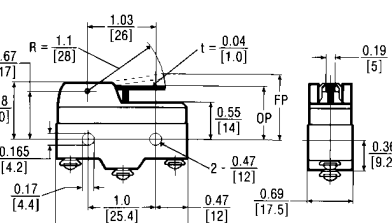



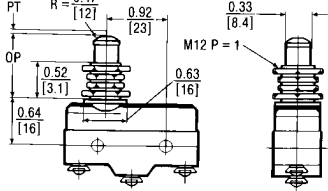

Model Selection — Basic Switches

	Type	Catalog Number		Specifications ①	Approximate Dimensions in Inches (mm)
		15A	20A		
 <p>Pin Plunger</p>	Screw Terminal	<b>E47BMS01</b>	<b>E47CMS01</b>	OF Max. — 12.3 oz (350g) RF Max. — 4.02 oz (114g) PT Max. — 0.016 in (0.4 mm) OT Max. — 0.005 in (0.13 mm) MD Max. — 0.002 in (0.05 mm) OP — 0.626 in (15.9 mm)	
	Solder Terminal	<b>E47BML01</b>	<b>E47CML01</b> ②		
 <p>Extended Plunger</p>	Screw Terminal	<b>E47BMS03</b>	—	OF Max. — 12.3 oz (350g) RF Max. — 4.02 oz (114g) PT Max. — 0.016 in (0.4 mm) OT Max. — 0.063 in (1.6 mm) MD Max. — 0.002 in (0.05 mm) OP — 1.11 in (28.2 mm)	
	Solder Terminal	<b>E47BML03</b>	—		
 <p>Straight Plunger</p>	Screw Terminal	<b>E47BMS02</b>	<b>E47CMS02</b>	OF Max. — 12.3 oz (350g) RF Max. — 4.02 oz (114g) PT Max. — 0.016 in (0.4 mm) OT Max. — 0.063 in (1.6 mm) MD Max. — 0.002 in (0.05 mm) OP — 0.846 in (21.5 mm)	
	Solder Terminal	<b>E47BML02</b>	<b>E47CML02</b>		
 <p>Reversed Lever</p>	Screw Terminal	<b>E47BMS21</b>	—	OF Max. — 5.29 oz (150g) RF Max. — 0.49 oz (14g) PT Max. — 0.16 in (4 mm) OT Max. — 0.063 in (1.6 mm) MD Max. — 0.051 in (1.3 mm) FP Max. — 0.81 in (20.6 mm) OP — 0.685 in (17.4 mm)	
	Solder Terminal	<b>E47BML21</b>	—		
	Spade Terminal	<b>E47BMT21</b>	—		
 <p>Straight Lever</p>	Screw Terminal	<b>E47BMS22</b>	<b>E47CMS22</b>	OF Max. — 2.47 oz (70g) RF Min. — 0.99 oz (28g) PT Max. — 0.394 in (10 mm) OT Max. — 0.220 in (5.6 mm) MD Max. — 0.051 in (1.3 mm) FP Max. — 1.11 in (28.2 mm) OP — 0.748 in (19 mm)	
	Solder Terminal	<b>E47BML22</b>	—		
 <p>Standard Lever</p>	Screw Terminal	<b>E47BMS20</b>	—	OF Max. — 3.53 oz (100g) RF Min. — 0.99 oz (28g) PT Max. — 0.197 in (5.0 mm) OT Max. — 0.079 in (2.0 mm) MD Max. — 0.039 in (1.0 mm) FP Max. — 0.976 in (24.8 mm) OP — 0.748 in (19 mm)	
	Solder Terminal	<b>E47BML20</b>	—		

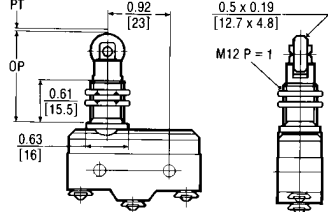
① OF = Operating Force; RF = Return Force; PT = Pre-travel; OT = Overtravel; MD = Movement Differential; FP = Free Position; OP = Operating Position.

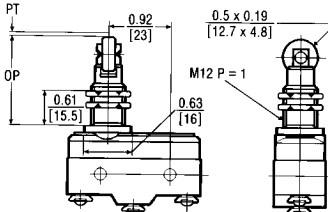
② Contact Eaton's Cutler-Hammer Sensor Applications Department at 1-800-426-9184 for approval status.

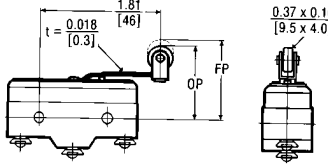

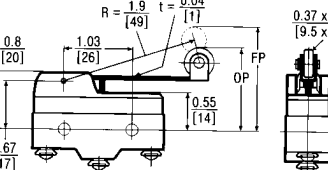



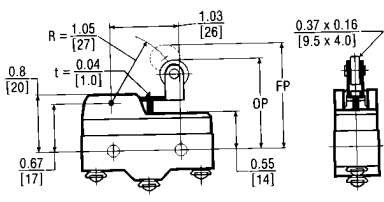

### Model Selection — Basic Switches (Continued)

	Type	Catalog Number		Specifications ①	Approximate Dimensions in Inches (mm)
		15A	20A		
 <p>Extended Straight Plunger</p>	Screw Terminal	<b>E47BMS04</b>	<b>E47CMS04</b>	OF Max. — 12.3 oz (350g) RF Max. — 4.02 oz (114g) PT Max. — 0.016 in (0.4 mm) OT Max. — 0.217 in (5.5 mm) MD Max. — 0.002 in (0.05 mm) OP — 0.858 in (21.8 mm)	
	Solder Terminal	<b>E47BML04</b>	<b>E47CML04</b>		
 <p>Roller Plunger</p>	Screw Terminal	<b>E47BMS10</b>	<b>E47CMS10</b>	OF Max. — 12.3 oz (350g) RF Max. — 4.02 oz (114g) PT Max. — 0.016 in (0.4 mm) OT Max. — 0.14 in (3.58 mm) MD Max. — 0.002 in (0.05 mm) OP — 1.315 in (33.4 mm)	
	Solder Terminal	<b>E47BML10</b>	—		
 <p>Cross Roller Plunger</p>	Screw Terminal	<b>E47BMS11</b>	<b>E47CMS11</b>	OF Max. — 12.3 oz (350g) RF Max. — 4.02 oz (114g) PT Max. — 0.016 in (0.4 mm) OT Max. — 0.14 in (3.58 mm) MD Max. — 0.002 in (0.05 mm) OP — 1.315 in (33.4 mm)	
	Solder Terminal	<b>E47BML11</b>	—		
 <p>Reversed Roller Lever</p>	Screw Terminal	<b>E47BMS41</b>	—	OF Max. — 5.29 oz (150g) RF Max. — 0.49 oz (14g) PT Max. — 0.16 in (4 mm) OT Max. — 0.063 in (1.6 mm) MD Max. — 0.051 in (1.3 mm) FP Max. — 1.252 in (31.8 mm) OP — 1.126 in (28.6 mm)	
	Solder Terminal	<b>E47BML41</b>	—		
 <p>Extended Roller Lever</p>	Screw Terminal	<b>E47BMS42</b>	<b>E47CMS42</b>	OF Max. — 5.64 oz (160g) RF Min. — 0.78 oz (22g) PT Max. — 0.28 in (7.1 mm) OT Max. — 0.16 in (4 mm) MD Max. — 0.04 in (1.02 mm) FP Max. — 1.437 in (36.5 mm) OP — 1.189 in (30.2 mm)	
	Solder Terminal	<b>E47BML42</b>	—		

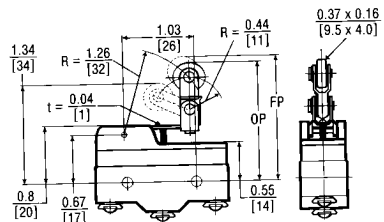
① OF = Operating Force; RF = Return Force; PT = Pre-travel; OT = Overtravel; MD = Movement Differential; FP = Free Position; OP = Operating Position.

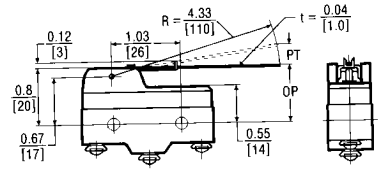

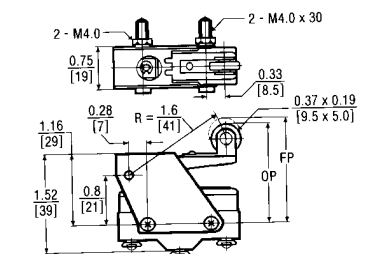
July 2005

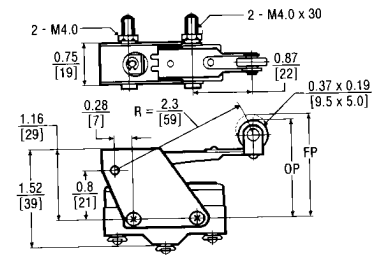
Model Selection — Basic Switches (Continued)



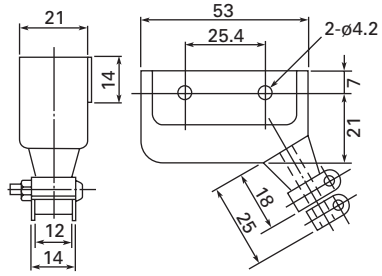

	Type	Catalog Number		Specifications ①	Approximate Dimensions in Inches (mm)
		15A	20A		
	Screw Terminal	<b>E47BMS30</b>	<b>E47CMS30</b>	OF Max. — 5.64 oz (160g) RF Min. — 1.48 oz (42g) PT Max. — 0.106 in (2.7 mm) OT Max. — 0.094 in (2.4 mm) MD Max. — 0.02 in (0.5 mm) FP Max. — 1.28 in (32.5 mm) OP — 1.189 in (30.2 mm)	
	Solder Terminal	<b>E47BML30</b>	—		
	Spade Terminal	<b>E47BMT30</b>	<b>E47CMT30</b>		
	Screw Terminal	<b>E47BMS31</b>	—	OF Max. — 5.64 oz (160g) RF Min. — 1.48 oz (42g) PT Max. — 0.106 in (2.7 mm) OT Max. — 0.094 in (2.4 mm) MD Max. — 0.02 in (0.5 mm) FP — 1.717 in (43.6 mm) OP — 1.697 in (43.1 mm)	
	Solder Terminal	<b>E47BML31</b>	—		
	Screw Terminal	<b>E47BMS23</b>	<b>E47CMS23</b>	OF Max. — 0.35 oz (10g) RF Min. — 0.106 oz (3.0g) PT Max. — 0.787 in (20.0 mm) OT Max. — 0.22 in (5.6 mm) MD Max. — 0.118 in (3.0 mm) OP — 0.748 in (19.0 mm)	
	Solder Terminal	<b>E47BML23</b>	—		
	Screw Terminal	<b>E47BMS40</b>	—	OF Max. — 17.64 oz (500g) RF Min. — 6.0 oz (170g) PT Max. — 0.197 in (5.0 mm) OT Max. — 0.5 in (12.7 mm) MD Max. — 0.087 in (2.2 mm) FP Max. — 1.752 in (44.5 mm) OP — 1.591 in (40.4 mm)	
	Solder Terminal	<b>E47BML40</b>	—		
	Screw Terminal	<b>E47BMS43</b>	—	OF Max. — 21.16 oz (600g) RF Min. — 10.58 oz (300g) PT Max. — 0.118 in (3.0 mm) OT Max. — 0.236 in (6.0 mm) MD Max. — 0.079 in (2.0 mm) FP Max. — 1.614 in (41 mm) OP — 1.591 in (40.4 mm)	
	Solder Terminal	<b>E47BML43</b>	—		

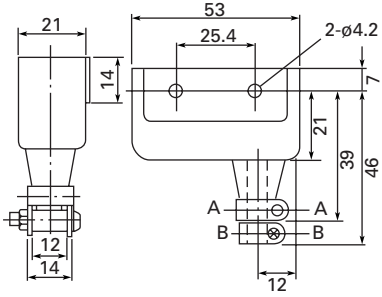
① OF = Operating Force; RF = Return Force; PT = Pre-travel; OT = Overtravel; MD = Movement Differential; FP = Free Position; OP = Operating Position.

Model Selection — Accessories — Terminal Wire Covers for Basic Switches

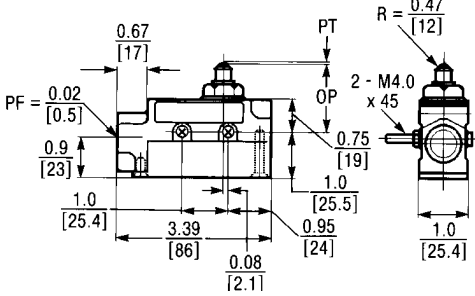
	Description	Catalog Number	Approximate Dimensions in mm
	Terminal wire cover with 45° conduit interface	<b>E47PA1</b>	
	Terminal wire cover with 90° conduit interface	<b>E47PA2</b>	

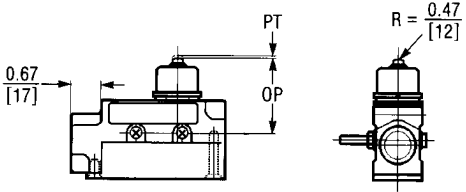
Model Selection — Enclosed Switches

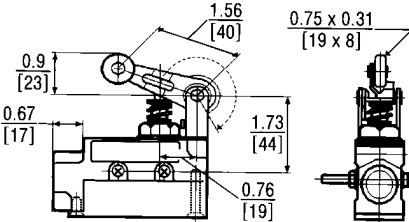
	Catalog Number	Specifications ①	Approximate Dimensions in Inches (mm)
	<b>E47BLS05</b>  <b>E47CLS05</b> ② (20 Amp version)	OF Max. — 8.82 – 12.3 oz (250 – 350g) RF Min. — 4.02 oz (114g) PT Max. — 0.016 in (0.4 mm) OT Max. — 0.217 in (5.5 mm) MD Max. — 0.002 in (0.05 mm) OP — 1.504 in (38.2 mm)	
	<b>E47BLS06</b>	OF Max. — 28.22 oz (800g) RF Min. — 8.46 oz (240g) PT Max. — 0.079 in (2.0 mm) OT Max. — 0.197 in (5.0 mm) MD Max. — 0.004 in (0.1 mm) OP — 1.803 in (45.8 mm)	
	<b>E47BLS32</b>  <b>E47CLS32</b> ② (20 Amp version)	OF Max. — 20.1 oz (570g) RF Min. — 6.0 oz (1700g) PT Max. — 0.157 in (4.0 mm) OT Max. — 0.236 in (6.0 mm) MD Max. — 0.016 in (0.4 mm)	









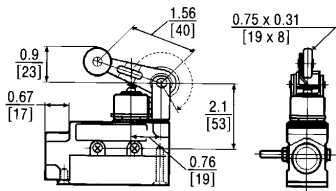

① OF = Operating Force; RF = Return Force; PT = Pre-travel; OT = Overtravel; MD = Movement Differential; FP = Free Position; OP = Operating Position.

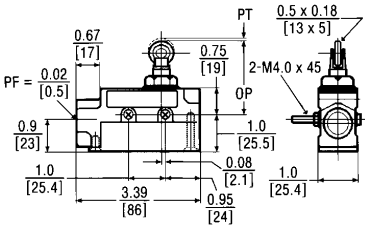
② Contact Eaton's Cutler-Hammer Sensor Applications Department at 1-800-426-9184 for approval status.

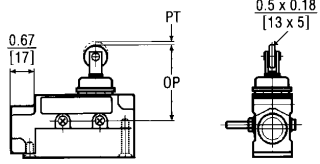
 Fast turn product with typical one day lead-time to shipment.

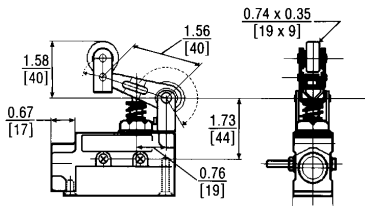
July 2005

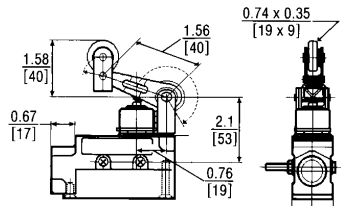
Model Selection — Enclosed Switches (Continued)

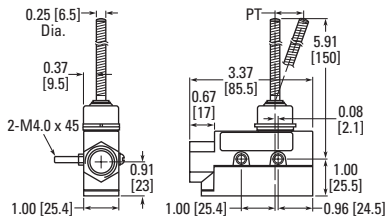
	Catalog Number	Specifications ①	Approximate Dimensions in Inches (mm)
	<b>E47BLS33</b>	OF Max. — 22.57 oz (640g) RF Min. — 8.11 oz (230g) PT Max. — 0.197 in (5.0 mm) OT Max. — 0.236 in (6.0 mm) MD Max. — 0.016 in (0.4 mm)	
	<b>E47BLS07</b>  <b>E47BLS11</b> (Cross Roller Unit)	OF Max. — 8.82 – 12.3oz (250 – 350g) RF Min. — 4.02 oz (114g) PT Max. — 0.02 in (0.5 mm) OT Max. — 0.142 in (3.6 mm) MD Max. — 0.002 in (0.05 mm) OP — 1.957 in (49.7 mm)	
	<b>E47BLS08</b>  <b>E47BLS12</b> (Cross Roller Unit)	OF Max. — 17.64 oz (500g) RF Min. — 3.53 oz (100g) PT Max. — 0.039 in (1.0 mm) OT Max. — 0.138 in (3.5 mm) MD Max. — 0.005 in (0.12 mm) OP — 1.957 in (49.7 mm)	
	<b>E47BLS34</b>	OF Max. — 20.1 oz (570g) RF Min. — 6.0 oz (170g) PT Max. — 0.157 in (4.0 mm) OT Max. — 0.236 in (6.0 mm) MD Max. — 0.016 in (0.4 mm)	
	<b>E47BLS35</b>	OF Max. — 22.57 oz (640g) RF Min. — 8.11 oz (230g) PT Max. — 0.197 in (5.0 mm) OT Max. — 0.236 in (6.0 mm) MD Max. — 0.016 in (0.4 mm)	
	<b>E47BLS14</b>	OF Max. — 2.11 oz (60g) RF Min. — 0.88 oz (25g) PT Max. — 0.520 in (13.2 mm) OT Max. — 0.315 in (8.0 mm) MD Max. — 0.039 in (1.0 mm)	

① OF = Operating Force; RF = Return Force; PT = Pre-travel; OT = Overtravel; MD = Movement Differential; FP = Free Position; OP = Operating Position.



### Specifications

Operating Speed	0.01m/second to 1m/second
Operating Frequency Mechanical Electrical	120 Operations/minute 20 Operations/minute
Mechanical Life	3,000,000 Operations minimum
Electrical Life	500,000 Operations minimum
Contact Resistance	15m Ohms maximum, initial
Insulation Resistance	100m Ohms minimum @ 500V DC
Dielectric Strength Between Non-current Carrying Parts Between Current Carrying Parts and Ground	1000V AC, 50/60 Hz for 1 minute 2000V AC, 50/60 Hz for 1 minute
Ambient Operating Temperature Basic Enclosed	-13° to 176°F (-25° to 80°C) 5° to 176°F (-15° to 80°C)
Environmental Rating Enclosed, Booted	NEMA 1
Mounting Centers	1.0 in (25.4 mm), #8 screw size
Terminal Screws	Bottom facing M4 x 0.7 (8 – 32) — Screws with cup washers will accept 22 – 12 AWG (2.5 sq. mm maximum)
Threaded Bushing	15/32 in
Material of Construction	Mineral filled phenolic
Enclosure Rating	Aluminum die casting (ADC-3/A380); Seal boot: Nitrile, butyl rubber (NBR)
Conduit Fitting On Enclosed Type	1/2 inch NPT

### Ratings <sup>①②</sup>

Model	Rated Voltage (V)	Non-inductive Load (A)			Inductive Load (A)			Inrush Current (A)	
		Resistive Load	Lamp Load		Inductive Load	Motor Load		N.C.	N.O.
			N.C. and N.O.	N.C.		N.O.	N.C.		
15A	125V AC	15	3	1.5	15	5	2.5	30 Max.	15 Max.
	250V AC	15	2.5	1.25	15	3	1.5		
	500V AC	3	1.5	0.75	2.5	1.5	0.75		
	8V DC	15	3	1.5	15	5	2.5		
	14V DC	15	3	1.5	10	5	2.5		
	30V DC	6 (2)	3	1.5	5	5	2.5		
	125V DC	0.4	0.4	0.4	0.05	0.05	0.05		
250V DC	0.2	0.2	0.2	0.03	0.03	0.03			
20A	125V AC	20	7.5	7.5	20	12.5	12.5	60 Max.	30 Max.
	250V AC	20	7.5	7.5	20	8.3	8.3		
	500V AC	6	4	4	5	2	2		
	8V DC	20	3	1.5	20	12.5	12.5		
	14V DC	20	3	1.5	15	12.5	12.5		
	30V DC	6	3	1.5	5	5	5		
	125V DC	0.5	0.5	0.5	0.05	0.05	0.05		
250V DC	0.25	0.25	0.25	0.03	0.03	0.03			

① Inductive load has a power factor of 0.04 minimum (AC) and a time constant of 7 m/second (DC).

② Lamp load has an inrush current of 6 times steady-state current.

### Terminal Configurations

