

gama

M
E
C
H
A
T
R
O
N
I
C
S

Panoramica prodotti 

Products overview 

Produktübersicht 

Gamme de produits 

Gama de productos 

Gama de produtos 

Ürünler 

产品概述 

製品一覽表 

제품 개요 

Distributors of Handling products

26/02/2016

GIMATIC
Group

CONSOCIATE ITALIANE

Piemonte, Liguria, Valle D'Aosta, Como, Lecco, Milano, Monza e Brianza, Pavia, Varese, Lodi, Verbania, Campania, Lazio, Puglia, Basilicata, Calabria Sicilia, Sardegna

GIMATRADE S.r.l.

Via Borgomanero, 1
28010 Veruno (NO)
Tel. +39 0322 830624
Fax +39 0322 830624
info@gimatrade.it
www.gimatrade.it

Bergamo, Brescia, Cremona, Mantova,

Sondrio

Bolzano, Trento

Verona

Piacenza, Parma, Reggio Emilia

Toscana

GIMATRADE BRESCIA S.r.l.

Via Chiusure, 5/b
25127 Brescia (BS)
Tel. +39 030 320212
Fax +39 030 2415436
info@gimatradebrescia.it
www.gimatradebrescia.it

Padova, Rovigo, Vicenza

Modena, Bologna, Ferrara, Ravenna,

Forlì e Cesena, Rimini

GIMATRADE VICENZA S.r.l.

Via Kennedy, 7
36040 Grisignano di Zocco (VI)
Tel. +39 0444 37 12 36
Fax +39 0444 37 12 36
info@gimatradevicenza.it
www.gimatradevicenza.it

Belluno, Treviso, Pordenone, Venezia, Udine,

Trieste, Gorizia

GIMATRADE TREVISO S.r.l.

Via Giovanni Verga, 21
33082 Corva di Azzano (PN)
Tel. +39 0434 646156
Fax +39 0434 646156
info@gimatradetreviso.it
www.gimatradetreviso.it

GIMATIC
Group

FOREIGN SUBSIDIARIES

Germany

GIMATIC VERTRIEB GmbH

Linsenäcker 18
72379 Hechingen
Ph. +49 7471 96015 – 0
Fax +49 7471 96015 – 19
zentrale@gimaticvertrieb.de
www.gimaticvertrieb.de

Spain

GIMATIC SPAIN s.l.

C/Corín Tellado nº8 - 1ª
33204 Gijón - Asturias - ESPAÑA
Ph. +34 984 493 897
Fax +34 984 493 897
jrodriguez@gimaticspain.es
www.gimaticspain.com

France

EURL GIMATIC FRANCE

265 rue Denis Papin
38090 Villefontaine - FR
Ph. 0033 768 380 865
Fax
vbecart@gimatic.fr
www.gimatic.fr

Czech Republic, Slovakia

GIMATIC CZECH REPUBLIC, s.r.o.

Pod Hájem 290
250 73, Přezletice
Ph. +420 608 954 500
Fax +420 222 364 605
info@gimatic.cz
www.gimatic.cz

Denmark, Iceland, Estonia, Lithuania, Latvia,

Finland, Sweden, Norway

GIMATIC NORDIC AB

Oestergarden 114
18637 Vallentuna - SE
Ph. +46 (8) 121 445 00
Fax +46 (0) 8 120 503 70
nordic@gimatic.se
www.gimatic.com

Turkey

GIMATIC OTOMASYON TICARET

LTD. STI.

Perpa Tic. Merk. A Blok Kat:11
No:1478
34160 Okmeydani, Istanbul
Ph. +90 212 210 83 91
Fax +90 212 210 83 98
gimatic@gimatic.com.tr

China, Hong Kong, Macao, Taiwan

GIMATIC AUTOMATION TECHNOLOGY (SHANGHAI) CO. LTD

Room 805, Block 8-9,
Lane 1500 South Lianhua Road
201108 Shanghai - CN
Ph. (+86) 021 54735580
Fax (+86) 021 54735680
info@gimatic-china.com
www.gimatic.com

South Korea

GIMATIC KOREA Limited

RN 215 27 Sankidaehak-ro
Siheung-si, Gyeonggi-do, Korea
(Jeongwang-dong, Rasung
Venture Town)
Ph. +82 31 504 8771
Fax +82 31 504 8772
sales@gimatic.co.kr
www.gimatic.co.kr

Central and Latin America

GIMATIC AUTOMAÇÃO Ltda

Rua Campos Salles, 190
09551-310 Bairro Barcelona
São Caetano do Sul
São Paulo - BRASIL
Ph. +55 11 4318 2550
Fax +55 11 4318 2551
gimatic@gimatic.com.br
www.gimatic.com.br

U.S.A., Mexico

GIMATIC USA

28300 Euclid Ave.
44092 Wickliffe, Ohio - USA
Ph. +1 216 535 4811
Fax +1 216 535 4833
sales@gimaticusa.com
www.gimaticusa.com

ITALIA

Ancona, Pesaro Urbino, Macerata

A.T.I. S.r.l. ARTICOLI TECNICI INDUSTRIALI

Via Bruno Buozzi, 8
60044 Fabriano (AN)
Tel. +39 0732 639 111
Fax +39 0732 626 641
vendite@ati-srl.com
www.ati-srl.com

Abruzzo, Ascoli Piceno, Fermo, Macerata

TKF S.r.l.

Via Dei Castani
64014 Martinsicuro (TE)
Tel. +39 0861 762 092
Fax +39 0861 797 942
acquisti@tkfsrl.com

EUROPE

Austria

BRUTECS GmbH
Groß-Dörnbach Straße, 12
A-4073 Wilhering
Ph. +43 664 380 6747
Fax +43 7221 87093
office@bruteecs.com
www.bruteecs.com

Belgium, Luxembourg

CS PLASTICS bvba
Spievelstraat 14
9160 Lokeren - BELGIUM
Ph. +32 9 262 04 60
Fax +32 (0)9 356 00 15
info@csplastics.be
www.csplastics.be

Bulgaria

MASTER Ltd
26 Tsar Asen Str.
7000 Ruse - BULGARIA
Ph. +35 982 836 530
Fax +35 982 826 530
ruse@master-bg.com
www.master-bg.com

Greece

TECNOPNEUMATIC A.E.
97, Iera Odos Str.
11855 Athens - GREECE
Ph. +30 210 346 70 00
Fax +30 210 347 99 30
avieris@tecnopneumatic.gr
www.tecnopneumatic.gr

Hungary

GRIP-PLAST Kft.
Ikva u.7
H-8000 Székesfehérvár
HUNGARY
Mobil +36 302 093 773
Ph. +36 227 883 90
Fax +36 227 883 90
a.jobbagy@grip-plast.hu
www.grip-plast.hu

Netherlands

GRIPPING & HANDLING SOLUTIONS B.V.
Amer 53
5711 KJ Someren
The Netherlands
Ph. +31 654 962 059
Fax +31 493 470 176
info@ghsolutions.com
www.ghsolutions.com

Polonia

DZV DOROTA ZDUNOWSKA
Plac Gornoslaski, 7
81509 Gdynia POLAND
Ph. +48 696 437 741
Fax +48 587 421 710
biuro@dzv.com.pl
www.dzv.com.pl

Portugal

TECNOTRONICA Lda.
Zona Industrial da Murteira,
Lote n.22
2135 Samora Correia
PORTUGAL
Ph. +351 263 659 340
Fax +351 263 659 349
tecnotronica@mail.telepac.pt
www.tmac.pt

Russia

IBC SYSTEMS
Kuskovskaya str.20A, off.611A
111141 Moscow - RUSSIA
Ph. +74 957 270 528
Fax +74 957 270 529
info@ibcplastic.ru
www.ibcplastic.ru

United Kingdom

PRECISION MOTION (COFIL) Ltd
PO BOX 2034, Preston
PR5 9AD Lancashire
Ph. +44 177 233 96 33
Fax +44 177 233 63 62
stuart@precisionmotion.co.uk
www.precisionmotion.co.uk

GEIGER HANDLING UK Ltd
Raleigh Hall Industrial Estate -
Eccleshall
ST21 6JL Stafford ENGLAND
Ph. +44 178 585 1111
Fax +44 178 585 9090
sales@geigerhandling.co.uk
www.gimatic.co.uk

Serbia, Slovenia, Croatia

KOVIMEX
Podskranik 60
1380 Cerknica - SLOVENIA
Ph. +386 (170) 96 430
Fax +386 (402) 18 211
kovimex@kovimex.si
www.kovimex.si

Switzerland

ROBXPPTS GmbH
Aachstrasse 2
9326 Horn - SWITZERLAND
Ph. +41 62 822 33 77
mail@robxperts.com
www.robxperts.com

ASIA

India

NEEJTECH INDIA
305, Swagat Building C.G. Road,
Ahmedabad
380009 - GUJARAT - IN
Ph. +91 98250 40231
Fax +91 79265 61312
info@neejtech.com
www.neejtech.com

Israele

R.E.P. Automation Ltd
2, HaAmelim St.
P.O.B.10115
Haifa Bay 26110
Ph. +97 248 403 012
Fax +97 248 403 013
rep@repac.co.il
www.repac.co.il

Malesia, Thailand

FUTURE STATE (Asia) Co. Ltd.
86/1 Soi Thianthayal, 22
Bangkhunthian
Thakham, Bangkhunthian
10150 Bangkok Thailand
Ph. +66 25 30 04 05
Fax +66 25 30 04 06
nianinbkk@hotmail.com
www.futurestateasia.com

Indonesia, Malesia, Thailand

OS PRECISION EQUIPMENT SDN BHD
N.13A, Jalan Kenari 17D
Bandar Puchong Jaya
47170 - Puchong, Selangor,
MALAYSIA
Ph. +60 380 750 833
Fax +60 380 600 666
osprecisions@gmail.com

AFRICA

South Africa

PLASTIC & CHEMICAL TRADING
PO BOX 92223 Norwood
2117 - SOUTH AFRICA
Ph. +27 11 483 3015
Fax +27 11 728 3419
matt@plastrading.com

AMERICA

Argentina

GENERAL AUTOMATION Srl
ALVEAR, 360
1619 GARIN (BUENOS AIRES)
Ph. +54 (0) 348 462 4481
am@ga-srl.com.ar
www.ga-srl.com.ar

Canada

SEMPRESS CANADA INC
9-3250 Ridgeway Drive
L5L-5Y6
Mississauga - Ontario - CANADA
Ph. 905.949.2324
Fax 905.949.1944
brentmccurdy@sempress.ca
www.sempress.ca

Chile, Peru



EQUIPAMIENTO Y AUTOMATIZACION PROAPSIS Spa
Las Calizas, 58
Cond. Los Portones Colina
9340000 Santiago - CL
Ph. +56 998 282 612
jvasquez@proapsis.cl
www.proapsis.cl

OCEANIA



Australia

ENKOSI PTY LTD
Unit 3/9 Nicole Close
3153 Bayswater noth vic
AUSTRALIA
Ph. +61 397 616 377
Fax +61 397 616 499
graham@enkosi.com.au
www.enkosi.com.au



Pinze elettriche parallele a 2 griffe
 2-jaw parallel electric grippers
 Elektrischer 2-Backen-Parallelgreifer
 Pincas eléctricas paralelas de 2 mordazas
 Pinças eléctricas paralelas de 2 mordentes
 2 çeneli paralel elektrikli tutucular
 双钳口平行电夹
 2ジョー平行電動グリッパ
 2-조 평행 전기 그리퍼

MPPM	F [N]	s [mm]	m [g]
MPPM1606	67	2x3	145
MPPM2508	125	2x4	330
MPPM3210	245	2x5	525





MPXM	F [N]	s [mm]	m [g]
MPXM1612	68	2x6	184
MPXM2516	95	2x8	390
MPXM3220	215	2x10	604

MPLM	F [N]	s [mm]	m [g]
MPLM1630	63	2x15	263
MPLM2535	98	2x17.5	500
MPLM3240	210	2x20	844

Pinze elettriche parallele a 3 griffe
 3-jaw parallel electric grippers
 Elektrischer 3-Backen-Parallelgreifer
 Pincas eléctricas paralelas de 3 mordazas
 Pinças eléctricas paralelas de 3 mordentes
 3 çeneli paralel elektrikli tutucular
 三钳口平行电夹
 3ジョー平行電動グリッパ
 3-조 평행 전기 그리퍼

MPTM	F [N]	s [mm]	m [g]
MPTM1606	57	3x3	183
MPTM2508	124	3x4	430
MPTM3210	220	3x5	693

Pinze elettriche angolari a 2 griffe
 2-jaw angular electric grippers
 Elektrischer Winkelgreifer mit 2 Backen
 Pincas eléctricas angulares de 2 mordazas
 Pinças eléctricas angulares de 2 mordentes
 2 çeneli açılı elektrikli tutucular
 双钳口角度电夹
 2ジョー・アンギュラー電動グリッパ
 2조 평행 전기 그리퍼



MPBM	C [Ncm]	s	m [g]
MPBM1640	68	2x23°	140
MPBM2540	151	2x23°	315
MPBM3240	277	2x23°	510

Pinze elettriche per materozze
 Electric sprue grippers
 Elektrischer Greifer für Angüsse
 Pincas eléctricas para mazarotas
 Pinças eléctricas para jitos
 Elektrikli sürgün tutucusu
 电动夹具
 電動スプリュー・グリッパ
 전기 스프루 그리퍼



MPBS	C [Ncm]	s	m [g]
MPBS1630	70	2x16°	145
MPBS1630S	70	2x16°	150

Pinze elettriche radiali a 2 griffe
 2-jaw radial electric grippers
 Elektrische Radialgreifer mit 2 Backen
 Pincas eléctricas radiales de 2 mordazas
 Pinças eléctricas radiais de 2 mordentes
 2 çeneli radyal elektrikli tutucu
 双钳口角度电夹
 2ジョー・ラジアル電動グリッパ
 2조 레이디얼 전기 그리퍼



MPRM	C [Ncm]	s	m [g]
MPRM1690	52	2x93°	210
MPRM2590	90	2x93°	445
MPRM3290	256	2x93°	730

Attuatori rotanti elettrici a 2 posizioni
 2 position electric rotary actuators
 Elektrische 2-Positions-Drehantriebe
 Vérins rotatifs électriques à 2 positions
 Actuadores rotatorios eléctricos de 2 posiciones
 Actuadores rotativos eléctricos de 2 posições
 2 konumlu elektrikli döner devindirici
 2点旋转型电动执行器
 2点電動回転型アクチュエータ
 2 포지션 전기 회전 액츄에이터



MRE	C [Ncm]	s	m [g]
MRE16180	45	90°/180°	195
MRE25180	80	90°/180°	400
MRE32180	138	90°/180°	738

Motori lineari
 Linear motors
 Linearmotoren
 Moteurs linéaires
 Motores lineales
 Motores lineares
 Doğrusal motorlar
 线性电机
 リニアモーター
 리니어 모터



ML	V [Vdc]	Ø [mm]	m [g]
ML2570X4	72	25	273
ML2570X6	72	25	384
ML25300X4	325	25	273
ML25300X6	325	25	384
ML4070X4	72	40	670
ML4070X6	72	40	940
ML40300X4	325	40	700
ML40300X6	325	40	980

Tavole rotanti elettriche
 Electric indexing tables
 Rotierende Elektro-Tische
 Tables rotatives électriques
 Mesas rotatorias eléctricas
 Mesas de indexação eléctricas
 Elektrikli endeksleme tabloları
 电动旋转模块
 電動インデックス・テーブル
 전기 인덱싱 테이블



MTRE	C [Ncm]	s	m [g]
MTRE3204C	196	4x90°	1800
MTRE3204A	196	4x90°	1800
MTRE3206C	196	6x60°	1800
MTRE3206A	196	6x60°	1800
MTRE3208C	196	8x45°	1800
MTRE3208A	196	8x45°	1800
MTRE3212C	196	12x30°	1800
MTRE3212A	196	12x30°	1800

Steli motore
 Motor sliders
 Motorschafte
 Tiges moteur
 Vástagos motor
 Hastes motor
 Motor milleri
 电机滑轨
 モータースライダー
 모터 슬라이더



ML	L [mm]	Ø [mm]	m [g]
ML12X10L218	218	12	190
ML12X13L271	271	12	235
ML12X16L325	325	12	285
ML12X20L395	395	12	350
ML12X27L519	519	12	460
ML12X33L625	625	12	560
ML12X38L715	715	12	655
ML12X44L820	820	12	735
ML20X10L238	238	20	490
ML20X14L309	309	20	620
ML20X18L380	380	20	760
ML20X21L433	433	20	865
ML20X27L542	542	20	1079
ML20X33L646	646	20	1285
ML20X44L842	842	20	1670
ML20X55L1042	1042	20	2055
ML20X72L1342	1342	20	2650

Sensori Encoder
Encoder sensors
Encoder Sensoren
Capteurs Encoder
Sensores Encoder
Sensores Encoder
Kodlayıcı sensorleri
编码传感器
エンコーダーセンサー
엔코더 센서



SE	V [Vdc]	r [mm/°]	m [g]
SE9ABZ1	5	±25 μm	19
SE9ABZ1-HR	5	±10 μm	19
SE9SIN1	5	-	19 (*)
SE9HALL1	5	±60°	19

(*)
Articolo in preparazione / Under construction / Artikel in Vorbereitung /
En cours de construction / Artículo en preparación / Em construção /
Yapım aşamasında
准备中
構築中
수리 중

Guide lineari elettriche
Electric linear guides
Elektrische Linearführungen
Guides linéaires électriques
Guías lineales eléctricas
Guías lineares eléctricas
Elektrikli doğrusal kılavuzlar
电动线性导轨
電動リニア・ガイド
전기 리니어 가이드



LVP	V [Vdc]	F [N]	s [mm]	m [g]
LVP250200-70	72	105.4	200	2730
LVP250300-70	72	105.4	300	3040
LVP250400-70	72	105.4	400	3330
LVP250500-70	72	105.4	500	3635
LVP250200-300	325	131.6	200	2730
LVP250300-300	325	131.6	300	3040
LVP250400-300	325	131.6	400	3330
LVP250500-300	325	131.6	500	3635
LVP400200-70	72	294	200	6350
LVP400300-70	72	294	300	7000
LVP400500-70	72	294	500	8200
LVP400700-70	72	294	700	9450
LVP401000-70	72	294	1000	11350
LVP400200-300	325	412	200	6350
LVP400300-300	325	412	300	7000
LVP400500-300	325	412	500	8200
LVP400700-300	325	412	700	9450
LVP401000-300	325	412	1000	11350

Attuatori lineari elettrici
Electric linear actuators
Elektrische Linearantriebe
Vérins linéaires électriques
Actuadores lineales eléctricos
Actuadores lineares eléctricos
Elektrikli doğrusal devindiriciler
电动线性执行器
電動リニア・アクチュエータ
전기 리니어 액츄에이터



LV	V [Vdc]	F [N]	s [mm]	m [g]
LV25050-70	72	98.1	50	1170
LV25100-70	72	98.1	100	1380
LV25150-70	72	105.4	150	1825
LV25200-70	72	105.4	200	2185
LV25050-300	325	117	50	1170
LV25100-300	325	117	100	1380
LV25150-300	325	131.6	150	1825
LV25200-300	325	131.6	200	2185
LV40050-70	72	287	50	2730
LV40100-70	72	287	100	3590
LV40150-70	72	294	150	4430
LV40200-70	72	294	200	4865
LV40050-300	325	421	50	2730
LV40100-300	325	421	100	3590
LV40150-300	325	412	150	4430
LV40200-300	325	412	200	4865







Bilanciatori a molla
Spring compensators
Federausgleicher
Égalisateurs à ressort
Equilibradores con muelle
Compensadores de mola
Yay kompensatörleri
弹簧平衡器
ばね補正器
스프링 컴펜세이터



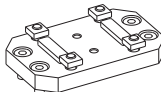

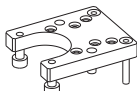
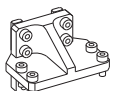
	s [mm]	m [g]
LV25-KIT-050	50	105
LV25-KIT-100	100	136
LV25-KIT-150	150	165
LV25-KIT-200	200	191

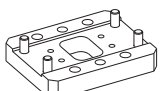
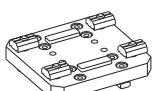

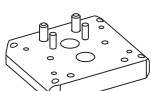
Accessori
Optionals
Zubehör
Accessoires
Accesorios
Acessórios
Aksesuarlar
 可选项
 付属品
 악세서리

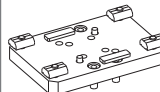
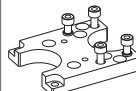
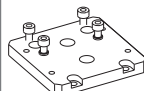
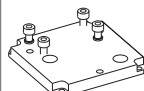
	m [g]
LV25-KIT-01	57
	m [g]
LV25-KIT-02	79 (*)
	m [g]
LV25-KIT-04	30
	m [g]
LV25-KIT-07	100
	m [g]
LV25-KIT-08	285
	m [g]
LV25-KIT-09	190
	m [g]
LV25-KIT-10	190
	m [g]
LV25-KIT-11	50
	m [g]
LV25-KIT-12	70

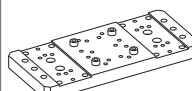
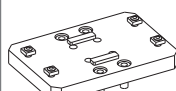
	m [g]
LV40-KIT-01	215
	m [g]
LV40-KIT-04	105
	m [g]
LV40-KIT-11	165
	m [g]
LV40-KIT-12	165
	m [g]
LV40-KIT-13	330
	m [g]
LV40-KIT-14	630
	m [g]
LV40-KIT-15	190

Opzioni circuito
 Circuit options
 Systemoptionen
 Option circuit
 Opciones de circuito
 Opções de circuito
 Devre seçenekleri
 回路选择
 回路オプション
 회로 옵션

VERSIONE PNP-NPN / VERSION PNP-NPN / PNP-NPN VERSION / VERSION PNP-NPN /
 VERSION PNP-NPN / VERSÃO PNP-NPN / PNP-NPN VERSİYONU / PNP-NPN 版本 / PNP-
 NPNバージョン / PNP-NPN 버전

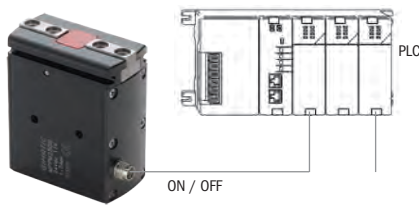
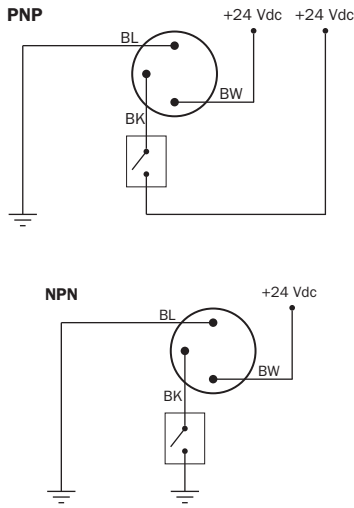

RIDUZIONE DI FORZA / FORCE REDUCTION / KRAFTREDUZIERUNG / RÉDUCTION DE
 FORCE / REDUCCIÓN DE FUERZA / REDUÇÃO DE FORÇA / GÜÇ DÜŞÜRME / 减小力量 /
 電力削減 / 힘 감소

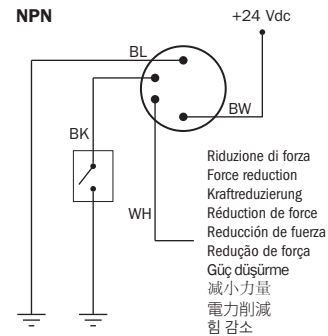
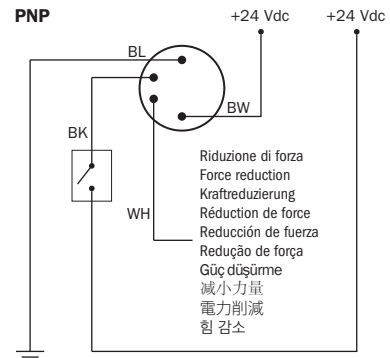

VERSIONE VELOCE 2Hz / 2Hz FAST VERSION / 2Hz SCHNELLVERSION / VERSION
 RAPIDE 2Hz / VERSION VELOZ 2 Hz / VERSÃO RÁPIDA 2Hz / 2Hz HIZLI VERSİYON / 2Hz
 快速版本 / 2Hz高速バージョン / 2Hz 빠른 버전

2Hz
 120 Picks/Minute

MPPM1606V
44 N
2x3 mm
2 Hz
DC 84%

Forza di presa
 Gripping force
 Greifkraft
 Force de prise
 Fuerza de aprehensión
 Força de prensão
 Kavrama kuvveti
 夹持力
 グリップ力
 약력

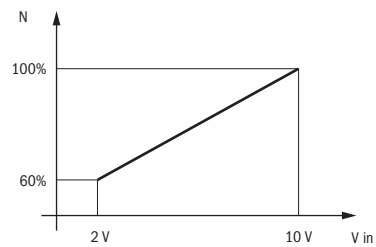

Tensione d'ingresso analogica
 Analog input voltage
 Analoge Eingangsspannung
 Tension d'entrée analogique
 Tensión de entrada analógica
 Tensão de entrada analógica
 Analog giriş gerilimi
 模拟输入电压
 アナログ入力電圧
 아날로그 출력 전압

Opzioni circuito
 Circuit options
 Systemoptionen
 Option circuit
 Opciones de circuito
 Opções de circuito
 Devre seçenekleri
 回路选择
 回路オプション
 회로 옵션

USCITA PICCO / PEAK OUTPUT / SPITZENLEISTUNG / SORTIE PIC / SALIDA PICO / SAÍDA PICO / PİK ÇIKIŞI / 峰值输出 / 피크出力 / 피크 출력

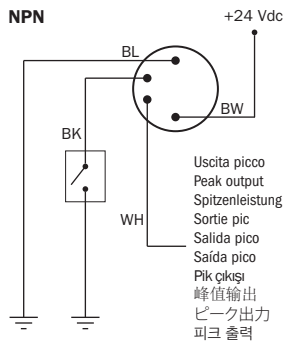
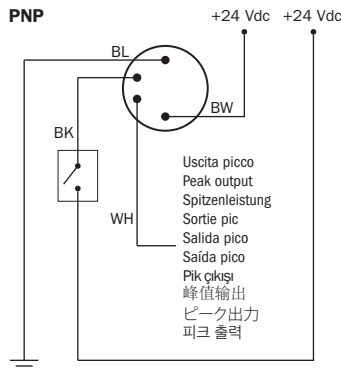

Tempo di lavoro pinza
 Working gripper time
 Greifer-Arbeitszeit
 Temps de travail pince
 Tiempo de trabajo de la pinza
 Tempo de trabalho da pinça
 Pense çalışma süresi
 抓取器运行时间
 그리퍼 작동 시간



Tensione d'uscita
 Voltage output
 Ausgangsspannung
 Tension en sortie
 Tensão de saída
 Çıkış gerilimi
 电压输出
 電圧出力
 전압 출력

USCITA POSIZIONE / POSITION OUTPUT / POSITIONSAUSGANG / SORTIE POSITION / SALIDA POSICIÓN / SAÍDA POSIÇÃO / POZİSYON ÇIKIŞI / 位置输出 / 位置出力 / 위치 출력

Uscita encoder
 Encoder output
 Encoder-Ausgang
 Sortie codeur
 Salida codificador
 Saída do encoder
 Enkoder çıkışı
 编码器输出
 엔코더 출력
 인코더 출력

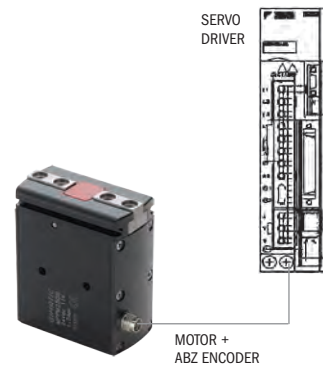
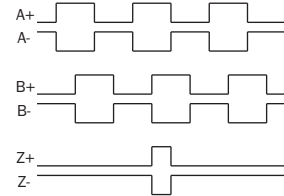

COMUNICAZIONE CON BUS DI CAMPO / FIELDBUS COMMUNICATION / KOMMUNIKATION MIT FELDBUS / COMMUNICATION AVEC BUS DE TERRAIN / COMUNICACIÓN CON BUS DE CAMPO / COMUNICAÇÃO COM BUS DE CAMPO / ENDÜSTRİYEL HABERLEŞME / 现场总线通信 / フィールドバス通信 / 필드버스 통신



Industry 4.0

Sensori magnetici per cave a "C"
 Magnetic sensors for "C" slot
 Magnetische Sensoren für "C" nuten
 Capteurs magnétique pour rainures à "C"
 Sensores magnéticos para ranuras en forma de "C"
 Sensor magnético para ranhuras em "C"
 "C" yarığı için manyetik sensörler
 C槽的磁传感器
 C型スロット用磁気センサー
 "C" 슬롯용 자기센서

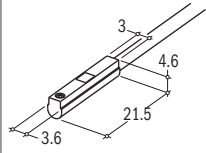

SS-G				m [g]
SS3N203-G	PNP	M8 connector	12	
SS4N225-G	PNP	2.5m cable	22	
SS3M203-G	NPN	M8 connector	12	
SS4M225-G	NPN	2.5m cable	22	

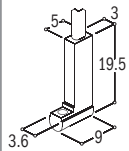

SN-G				m [g]
SN3N203-G	PNP	M8 connector	12	
SN4N225-G	PNP	2.5m cable	22	
SN3M203-G	NPN	M8 connector	12	
SN4M225-G	NPN	2.5m cable	22	

Sensori induttivi
 Inductive sensors
 Induktive Sensoren
 Capteurs inductifs
 Sensores inductivos
 Sensores indutivos
 Endüktif sensörler
 电感式传感器
 誘導センサー
 인덕티브 센서



SI				m [g]
SI4M225-G	NPN	2.5m cable	20	
SI4N225-G	PNP	2.5m cable	20	

Connettore
 Connector
 Steckverbinder
 Connecteurs
 Conector
 Conectores
 Bağlantı
 连接器
 コネクタ
 커넥터

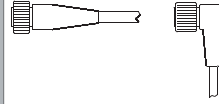

CF		# Pin	L [m]	m [g]
CFGM800325P	M8 axial	3	2.5	104
CFGM890325P	M8 angular	3	2.5	104
CFGM800425P	M8 axial	4	2.5	105
CFGM890425P	M8 angular	4	2.5	105
CFGM1200525P	M12 axial	5	2.5	108
CFGM1290525P	M12 angular	5	2.5	108
CFGM1200825P	M12 axial	8	2.5	173
CFGM1290825P	M12 angular	8	2.5	173
CFGM1200430P	M12 axial	4	3	125
CFGM1290430P	M12 angular	4	3	125

Esempio di applicazione
Application examples
Anwendungsbeispiele
Exemples d'application
Ejemplo de aplicación
Exemplo de aplicação
Uygulama örnekleri
实例应用
用途例
적용 예

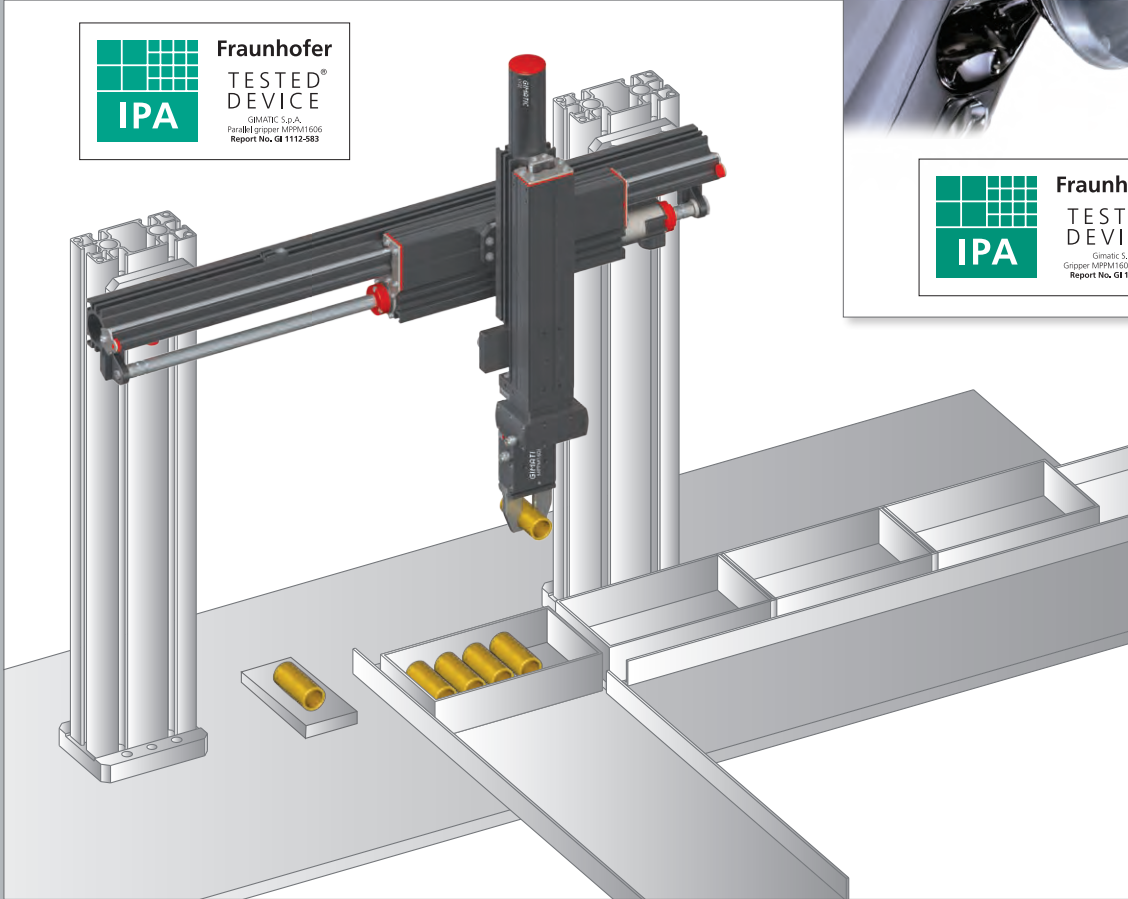

F [N]	Forza	Force	Kraft	Force	Fuerza	Força	Kuvvet	力	力	힘
C [Ncm]	Coppia	Torque	Drehmoment	Couple	Par	Binário	Tork	扭矩	トルク	토크
s [mm]	Corsa	Stroke	Hub	Course	Carrera	Curso	Strok	行程	ストローク	스트로크
m [g]	Peso	Weight	Gewicht	Poids	Peso	Peso	Ağırlık	重量	重量	중량
V [Vdc]	Alimentazione	Power Supply	Betriebsspannung	Alimentation	Alimentación	Alimentação	Güç Kaynağı	动力供应	パワーサプライ	전력 공급
L [m]	Lunghezza	Lenght	Länge	Longueur	Longitud	Comprimento	Boy	长度	長さ	길이
r [mm/°]	Risoluzione	Resolution	Auflösung	Résolution	Resolución	Resolução	Çözünürlük	分辨率	解像度	해결

Riservati tutti i diritti, traduzioni incluse. Proibita ogni forma di riproduzione o trasmissione senza permesso scritto ed approvato da GIMATIC Srl. Con riserva di modifiche ed aggiornamenti in qualsiasi momento e senza alcun preavviso.

All rights reserved, including translation rights. No parts of this publication may be reproduced or transmitted in any form or by any means, electronic, mechanical, photocopying or otherwise, without the prior written permission of GIMATIC Srl. We reserve the right to make alterations.

Alle Rechte, einschließlich Übersetzungen, vorbehalten. Jede Form von Vervielfältigung oder Übermittlung ohne eine schriftliche und von GIMATIC Srl genehmigte Bevollmächtigung ist untersagt. Unter Vorbehalt von jederzeit und ohne Vorankündigung antragbaren Änderungen und Erneuerungen.

Réservés tous droits, traductions incluses. Toutes formes de reproduction ou transmission par quelque procédé que ce soit, interdites sans autorisation écrite préalable par GIMATIC Srl. Avec réserve de modifications et de mise à jour sans préavis.

Todos los derechos reservados, incluyendo los derechos de traducción. Ninguna parte de esta publicación puede ser reproducida o transmitida en ninguna forma y por ningún medio, sea electrónico, mecánico, fotocopia u otro, sin permiso previo por escrito de Gimatic Srl. La empresa se reserva el derecho de aportar modificaciones sin previo aviso.

Todos os direitos reservados, inclusas traduções. É proibida qualquer forma de reprodução ou transmissão sem a autorização escrita e aprovada pela GIMATIC Srl. Reservamo-nos o direito de efectuar modificações e actualizações em qualquer momento e sem aviso prévio.

Çeviri hakkı dahil her hakkı saklıdır. Bu yayının hiç bir kısmı GIMATIC Srl'nin yetkili yazılı izni olmadan çoğaltılamaz veya elektronik, mekanik, fotokopi ve diğer yollarla, herhangi bir biçimde, yayınlanamaz. Değişiklik yapma hakkı bizde saklıdır.

本书所提及的内容, 包括翻译在内的版权均归GIMATIC Spa所有, 在无GIMATIC的书面授权下, 不得以任何电子或纸张的形式复制或传播本刊物。我们保留修改的权力。

著作権所有。翻訳を含め、すべての著作権所有。本発行物のいかなる部分であっても、GIMATIC SpAの事前の書面による許可なく、電子的、機械的に複製、送信すること、コピーならびにその他の手段を取ることは、いかなる形式、手段であれ禁じられています。当社は変更を行う権利を有しております。

번역권 포함 판권 분사 소유. 본 간행물의 그 어떤 부분도 GIMATIC Srl의 사전 서면 동의 없이 전자적, 기계적, 복사 또는 기타 그 어떤 방식으로든 재생산 또는 전할 수 없습니다. 변형에 대한 권리는 분사에 있습니다.



Visitate il nostro sito ed avrete a disposizione tutti gli strumenti necessari con gli aggiornamenti, in tempo reale, sulle ultime novità di prodotto, i prezzi e la rete di vendita. L'offerta Gimatic, oltre ai prodotti della sezione MECHATRONICS mostrati in questa brochure, comprende una sezione HANDLING dedicata ai componenti per la manipolazione generale, una sezione PLASTICS dedicata ai componenti per l'asservimento di presse per stampaggio ed una sezione SENSORS dedicata ai sensori per l'automazione.



Besuchen Sie unsere Website, dort finden Sie alle notwendigen technischen Informationen, die aktuellen Produktneuheiten, Preislisten und eine Übersicht zur Vertriebsstruktur. Neben den in dieser Broschüre gezeigten Produkten der Rubrik MECHATRONICS enthält das Angebot von Gimatic die Rubrik HANDLING, die den Bestandteilen der allgemeinen Handhabung gewidmet ist, die Rubrik PLASTICS, die Komponenten für Spritzgusspressen umfasst, und die Rubrik SENSORS, die Automationsensoren beinhaltet.



Visite nuestro sitio y tendrá a disposición todas las herramientas necesarias con todas las actualizaciones, en tiempo real, sobre las últimas novedades de los productos, los precios y la red de ventas. La oferta Gimatic, además de los productos de la sección MECHATRONICS indicados en este folleto, incluye una sección HANDLING dedicada a los componentes para la manipulación en general, una sección PLASTICS dedicada a los componentes para prensas de moldeado y una sección SENSORS dedicada a los sensores para la automatización.



Ürünlerimiz ve satış ağımla ilgili en güncel bilgiye ulaşmak, yeni ürünlerimizden haberdar olmak için internet sitemizi ziyaret edin. İşbu brüshün MECHATRONICS bölümünde yer alan ürülene ek olarak Gimatic, genel kullnım uygulamalarına yönelik pnömatrik bileşenlere dair bir HANDLING bölümü, enjeksiyon döküm makinelerinin ara bağlantı parçalarına ayrılmış bir PLASTICS bölümünü ve otomasyon sensorlarına tahsis edilmiş bir SENSORS bölümü sunmaktadır.



我が社のホームページをご覧になったら、リアルタイムで製品に関する最新のニュース、価格、販売網などを知ることができます。Gimatic社のラインアップは、本パンフレットに掲載されているMECHATRONICSセクションの製品に加え、一般のハンドリング部品用の空気圧式コンポーネントに関連するHANDLINGセクション、射出成形機用の連動コンポーネント専門のPLASTICSセクション、自動化用センサー専用のSENSORSセクションがあります。



Visit our website: you will have access to all the necessary tools with real-time updates on the latest news, prices and sales network. In addition to the products of the MECHATRONICS section shown in this brochure, the Gimatic offer includes a HANDLING section concerning pneumatic components for general handling applications, PLASTICS section dedicated to interlocking components for injection moulding machines and a SENSORS section dedicated to sensors for automation.



Visitez notre site et vous aurez à disposition tous les instruments nécessaires avec toutes les mises à jour, en temps réel, sur les dernières nouveautés du produit, ainsi que la liste des prix et le réseau de vente. L'offre Gimatic, en dehors des produits de la section MECHATRONICS montrés dans cette brochure, comprend une section HANDLING, dédiée aux composants pour la manipulation générale, une section PLASTICS, dédiée aux composants pour l'asservissement de presses de moulage, et une section SENSORS, dédiée aux capteurs pour l'automatisation.



Visite o nosso site e terá ao seu dispor todos os instrumentos necessários de atualização, em tempo real, para as últimas novidades dos produtos, assim como a lista de preços e a rede de vendas. A oferta Gimatic, para além dos produtos da secção MECHATRONICS ilustrados no presente folheto, inclui uma secção HANDLING, dedicada aos componentes para a manipulação geral, uma secção PLASTICS, dedicada aos componentes para mecanismos de prensas para moldagens e uma secção SENSORS, dedicada aos sensores para a automatização.



您可以通过登录我们的网站获得最新的新闻和销售网络信息。除宣传册中提及的电驱装置外，Gimatic的销售产品还包括自动化部件，治具和传感器。



저희 웹사이트를 방문하시면 최근 제품 소식, 가격 목록, 판매 네트워크 등에 대한 실시간 업데이트와 함께 필요한 모든 도구를 이용하실 수 있습니다. Gimatic는 본 브로셔에 나와 있는 MECHATRONICS 제품 섹션만이 아니라 범용 취급 애플리케이션용 공압 부품인 HANDLING 섹션, 사출 성형기용 인터록킹부품 전용인 PLASTICS 섹션, 자동화를 위한 전용 센서인 SENSORS 섹션 등을 제공합니다.

H A N D L I N G



P L A S T I C S

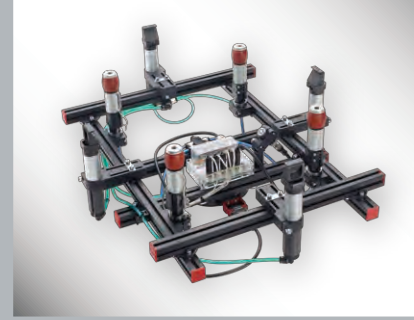

S E N S O R S



M E C H A T R O N I C S



Gimatic S.r.l.

Via Enzo Ferrari, 2/4 - 25030 Roncadelle (BS) - ITALIA
Tel. +39 030 2584655 - Fax +39 030 2583886
www.gimatic.com - sales@gimatic.com

