



RESISTANCE THERMOMETERS



D

■ GENERAL

Resistance Thermometers are used widely from -200 to $+850^{\circ}\text{C}$ in different processes. Especially at low temperatures, resistance thermometers are preferred since their accuracy is much better than thermocouples. Up to 500°C standard types and between $500 - 850^{\circ}\text{C}$ special types are used. The maximum temperatures given in the catalogue are in the air where there are not hazardous gases. In different processes, the life of the resistance thermometer will be different according to the corrosive media.

The application for the resistance thermometers,

- Tanks, pipes and engines, etc
- In gaseous or liquid media, such as air, vapour, gases, water, oil etc..
- Low and high pressure applications
- Surface measurements

■ DESIGN AND SELECTION

In order for the life-time of the resistance thermometer to be as long as possible and the results taken within this period to be reliable, resistance thermometer element, protecting tube and the type should be chosen according to process conditions.

■ RESISTANCE THERMOMETER STANDARD

Resistance Thermometer element Pt-100 and Ni-100 give resistance values according to DIN standard 43760 Pt-100 and Ni-100 elements have 100 ohms resistance value at 0°C . Resistance thermometers are manufactured with inset. Resistance thermometer bulb is first installed into the inset metal tube and it is filled with metal oxide powder. Then this inset is inserted into outertube. The advantage of inset is that it can be changed when it is damaged, without interrupting the process.

■ PROTECTING TUBES

Protecting tubes should be chosen according to the process. Most common tubes are used to produce resistance thermometers;

- Brass
 - 1.4301 (304 quality stainless steel)
 - 1.4571 (316 quality stainless steel)
- For insets, 1.4301 metal tubes are used.

■ CONNECTION HEADS

B type aluminium cast heads are used for resistance thermometers. Inset is fixed to a ceramic terminal block which in turn is secured into the connection head by two spring loaded screws. Heads are according to DIN43729 standards. The temperature of the aluminium heads are limited with the temperature limits of the extension cables.

■ MOUNTING METHOD

The resistance thermometers in this catalogue are designed to be mounted by mounting bushes or flanges. Surface types should be well-mounted to the surface of the body.

■ INSTALLATION INSTRUCTIONS

The maximum immersion length of the resistance thermometers should be determined by considering the measurement errors that may be caused by heat transfer occurring along the protecting tube and R/T element. The fluid speed where the resistance thermometer is immersed is a factor affecting the measurement sensitivity. In general, R/T should be perpendicular to the flow direction. Copper conductive cables are used between resistance thermometer head and the instruments. Up to 10 meters, 2x1.5 mm copper cable, up to 150 meters 3x1.5 mm copper cable are used. In order to get accurate measurement, immersion length of the thermocouple should be not less than 10 times of the external diameter.

■ STANDARD TYPES

The standard types ordered by the customers are delivered in short periods and at reasonable prices provided that the priority is given to the competition factors. To choose the standard type of resistance thermometers are easy by using code list and can be delivered from stock.

■ SPECIAL TYPES

Special types according to the application can be ordered by giving the answers of the questions below.

- a) Application
- b) Continuous and maximum operating temperatures
- c) Technical drawings with size, diameter and other details,
- d) Product code number, if ordered previously
- e) Pressure and flow data if known
- f) Chemical corrosion factors

■ SPARE PARTS

All kinds of spare parts of resistance thermometers can be ordered by using the selection table in the catalogue. According to the stock level, the spare parts may be delivered from stock or within a certain delivery period.

■ REPAIR

Repair of the resistance thermometers is not economical if almost all the elements are defective. As stated in the resistance thermometer spare section only when either the tube or the inset is working the other component can be repaired using spare parts.

■ HOW TO ORDER

a) Standart Types

Standard types are coded by using drawing number and 5 different groups of alpha numeric characters

b) Special types

Special features are defined in the 5.digit or by additional information added to the end of the 5.digit. Fully special types are subjected to a different coding.

Example

RT01 - 1 K 09 -50 - U
1 2 3 4 5

- According to drawing nr. RT01
- With single element 1xPt-100
- Protecting tube 1.4571
- Protecting tube diameter 9 mm
- Immersion length 500 mm
- Three-wire installation

Elimko Resistance Thermometer Coding

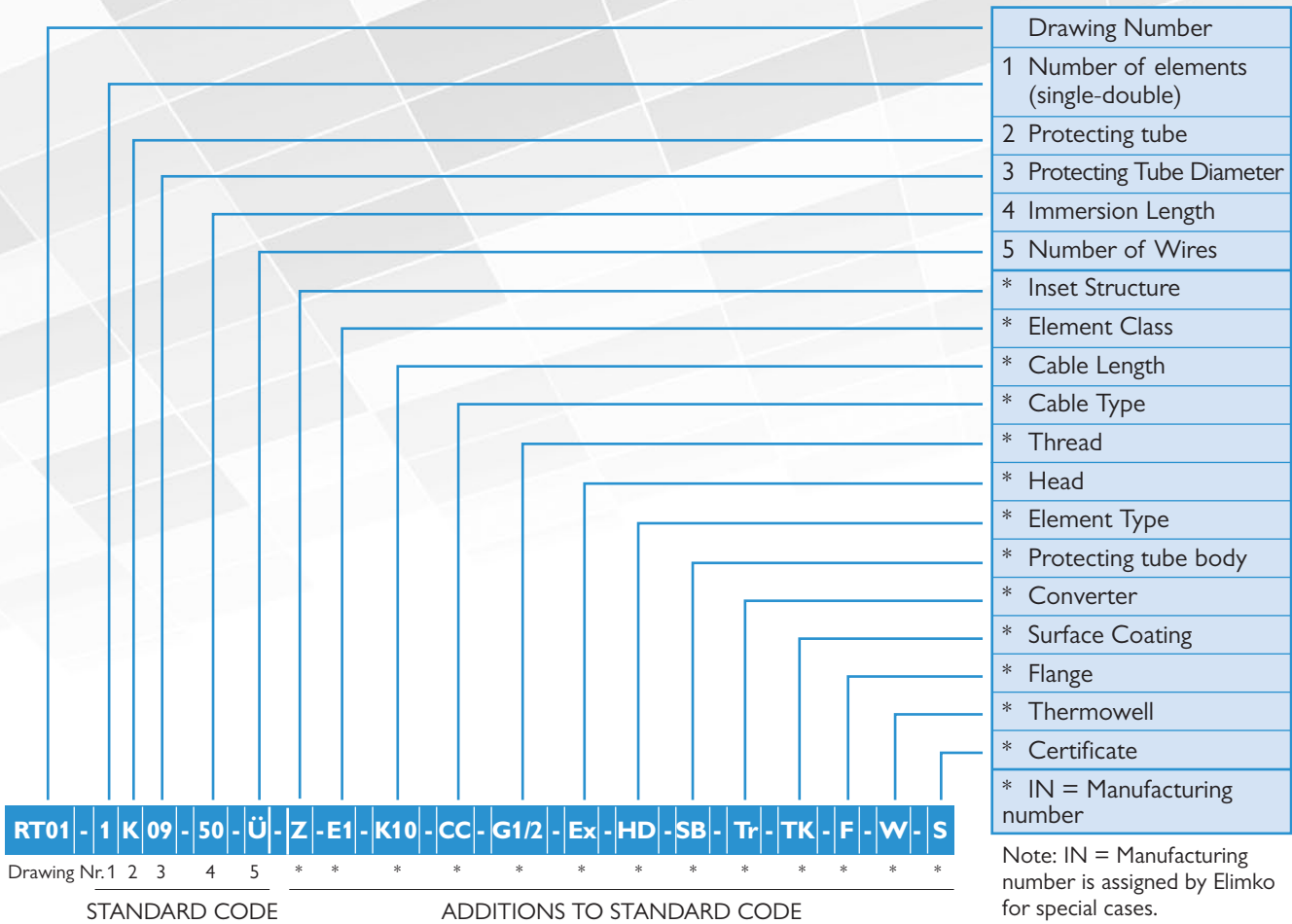

STANDARD CODE

It is coded with digits and letters containing the drawing number and 5 separate pieces of information.

ADDITIONS TO STANDARD CODE

In addition to the technical specifications contained in the standard codes, the required features are listed in the "ADDITIONS TO STANDARD CODE". These features are given below. In this section only needed features are written. See examples.

SPECIAL CASES

Additional features which are not fully defined with "STANDARD CODE" and "ADDITIONS TO STANDARD CODE" are coded with special drawing number. This code is expressed with IN=Manufacturing number.

Drawing Number	RT01, RT02, RT03, RT04, RT05, RT06, RT07, RT07-1, RT07-I, RT07-H, RT07-HD, RT07-Y, RT07-YA, RT08, RT09, RT10, RT11, RT15, RT16, RT21, RT22, RT23, RT24, RT25, RT26, RT27, RT28, RT29, RT30-N, RT30-NU, RT30-NUN, RT30-R, RT30-RK	Resistance thermometers are coded with different drawing numbers												
1- Element Number	(1) Single Element (2) Double Element	1 or 2 comes in the 1. digit in accordance with the number of the elements of resistance thermometers												
2- Protecting tube	<table border="0"> <tr> <td>D St-35.8</td> <td>K 1.4571 (316 Ti)</td> </tr> <tr> <td>I Inconel</td> <td>L 1.4749 / 1.4762 / 446</td> </tr> <tr> <td>P 1.4301 (304)</td> <td>N 1.4841 / 1.4845 / 310S</td> </tr> <tr> <td>E 1.4401 (316)</td> <td>Y KER 610</td> </tr> <tr> <td>H 1.4404 (316L)</td> <td>Z KER 799</td> </tr> <tr> <td>J 1.4541 (321)</td> <td>T Teflon</td> </tr> </table>	D St-35.8	K 1.4571 (316 Ti)	I Inconel	L 1.4749 / 1.4762 / 446	P 1.4301 (304)	N 1.4841 / 1.4845 / 310S	E 1.4401 (316)	Y KER 610	H 1.4404 (316L)	Z KER 799	J 1.4541 (321)	T Teflon	In 2. digit, the material of protecting tube is given by selecting in accordance with the process.
D St-35.8	K 1.4571 (316 Ti)													
I Inconel	L 1.4749 / 1.4762 / 446													
P 1.4301 (304)	N 1.4841 / 1.4845 / 310S													
E 1.4401 (316)	Y KER 610													
H 1.4404 (316L)	Z KER 799													
J 1.4541 (321)	T Teflon													

3- Protecting tube Diameter (mm)	02 08 14 20 30 03 09 15 22 32 04 10 16 24 05 11 17 26 06 12 18 28 Note: These sizes are in mm	MIINERAL INSULATED 20 2.0 mm 60 6.0 mm 30 3.0 mm 80 8.0 mm 45 4.5 mm 09/06 D=9 mm d=6 mm 14/12 D=14 mm d=12 mm	In 3.digit, the material of protecting tube is given by selecting in accordance with the process.
4- Resistance Thermometer length (immersion in cm)	05 50 200 10 71 16 100 18 120 25 140 35 160 Note: These sizes are in mm Only inset lengths given in mm	50/74 L ₁ =50 L=74 71/91 L ₁ =70 L=91	In 4.digit, the immersion length is given. In order to ensure an accurate measurement, immersion length of the resistance thermometers should be at least 6 or 10 times of the protecting tube diameter. Note: 4.digit has two digits.
5- Number of wires	It is not written if 2 wires exit	Ü 3 wires D 4 wires	Element wire number is written on the 5 th digit.
* Inset Structure	Z no insets M with insets	Note: If no expression is written for inset it means it has standard insets.	
* Element Class	E1 Pt-100 - Ceramic - A class E2 Pt-100 - Ceramic - B class E3 Pt-100 - Film - A class E4 Pt-100 - Film - B class	E5 Pt-1000 - Ceramic - A class E6 Pt-1000 - Ceramic - B class E7 Pt-1000 - Film - A class E8 Pt-1000 - Film - B class	E9 Pt-50 E10 Pt-500 E11 Ni 100 E12 Other elements
* Cable Length	K05 50 cm K10 1 m	K15 1.5 m K20 2 m	K25 2.5 m ...
* Cable Type	SS Silicon +Silicon CC Fiber Glass+Fiber Glass TT Teflon + Teflon	PP PVC + PVC CCB Fiber Glass+Fiber Glass+Annealing SCB Silicon + Fiber Glass + Annealing	Note: Please contact Elimko for other cable types.
* Thread	G1 G½ G¼ G⅝ G1 S Adjustable ...	1NPT ½NPT ¼NPT ⅜NPT 1NPT S Adjustable ...	M10x1 M12x1 M12x1.5 M27x2 M10x1 S Adjustable ...
* Head	A Type A head B Type B head C1 Type C1 head	C2 Type C2 head P Plastic head SS Stainless head	Ex Type Exx head ½" Ex-proof certified
* Element Type	H Air slot I Needle type HD Air Hole	UA Open Ended Y Surface YD Surface Spherical	YA Surface Angle YU Surface type open V Vibrationı resistant
* Protecting tube body	SB Perforated with fill material PSB Half Pipe – half full		Protecting tube can be machined from pipe and rod material. If the protecting tube is a pipe, no letters written.
* Converter	Tr Elimko converter installed range Tr/l Elimko insulated converter installed Tr/k To use Elimko converter Tr/d Other brand converter to be installed Tr/dk To use other brand converter	(Specify the during order.)	Elimko or other brand converters can be installed in the thermocouple head.
* Surface Coating	TK Teflon coating TH Teflon hose STK Stellitecoating		Protecting tubes can be coated with known materials. If it is coated, it is coded according to its type.
* Flange	F Flange exists. Flange codes valid.		It means flange exists if F is written on the flange digit. Please refer to its catalogue for flange details.
* Thermowell	W Thermowell exists. Thermowell codes are valid.		It means thermowell exists if W is written on Thermowell digit. Please refer to Elimko catalog for Thermowell details.
* Certificate	S calibration certificate		Note: Please refer to Elimko for your certificate.

Elimko Resistance Thermometers



RT01



RT02

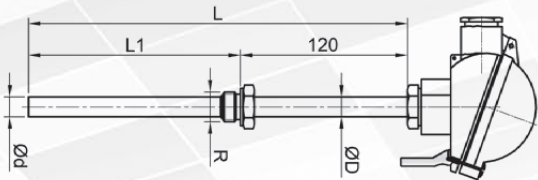

RT03

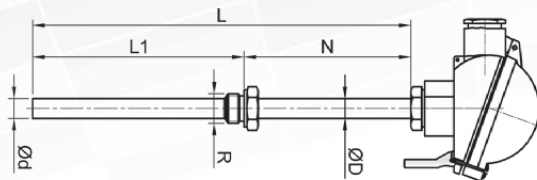

RT04

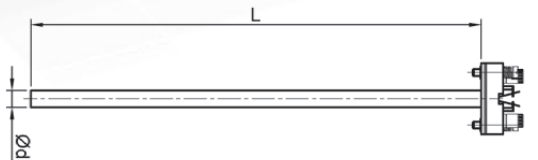

RT05

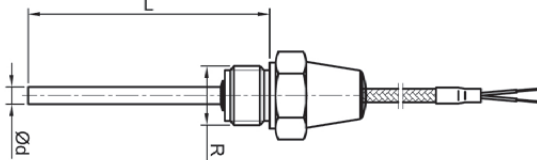

RT06

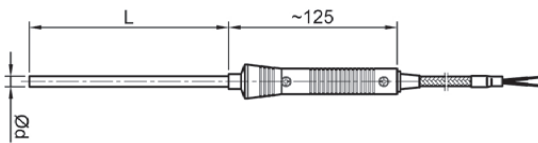

RT07

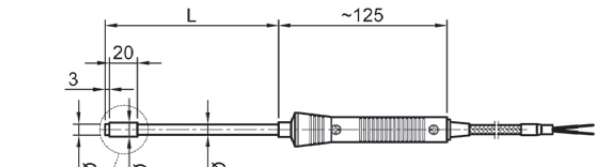

RT07-Y

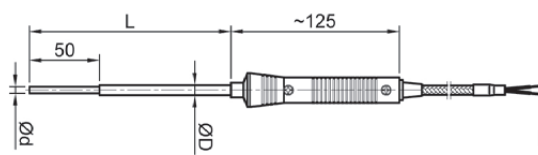

RT07-1

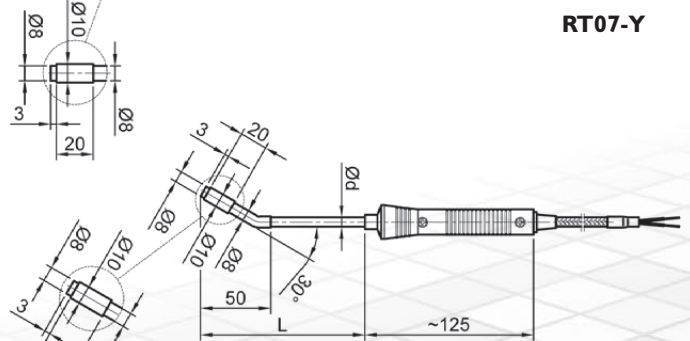

RT07-YA

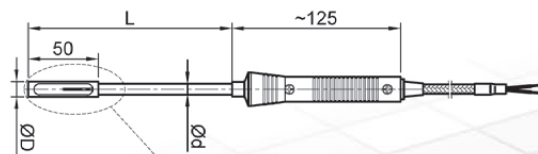

RT07-H

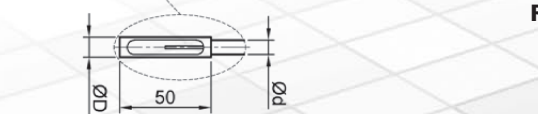

RT07-HD

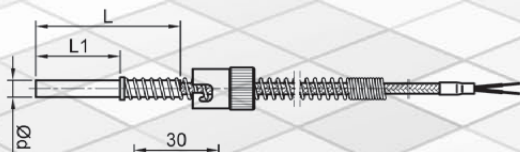

RT08

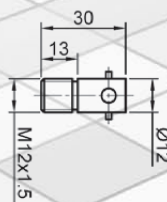

D

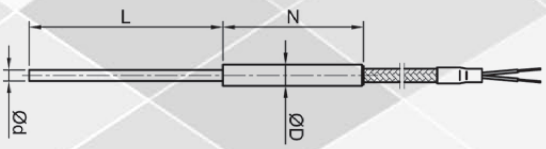

RT09

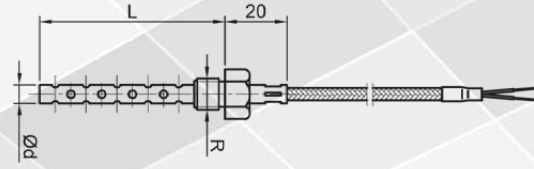

RT10



RT11

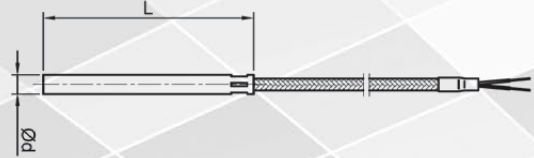

RT15

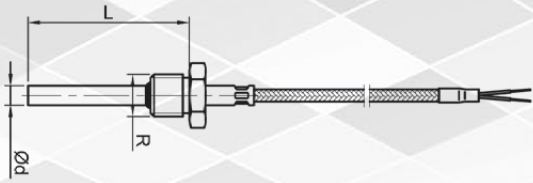

RT16

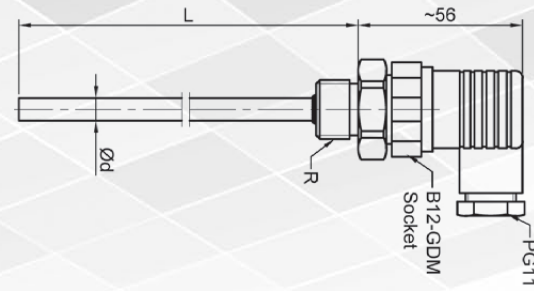

RT21

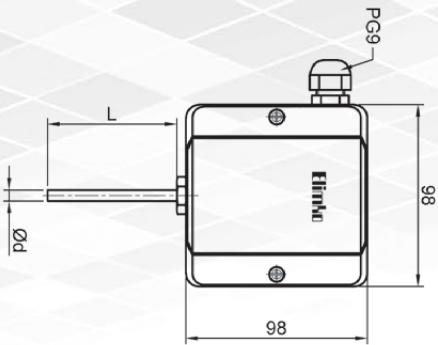

RT22

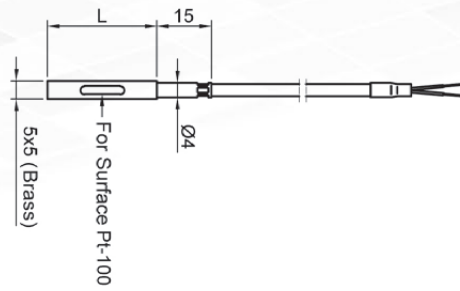

RT23

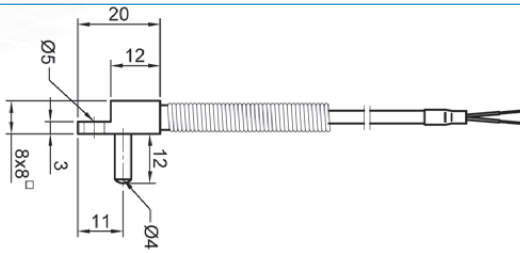

RT24

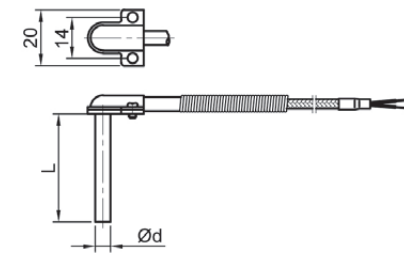

RT25

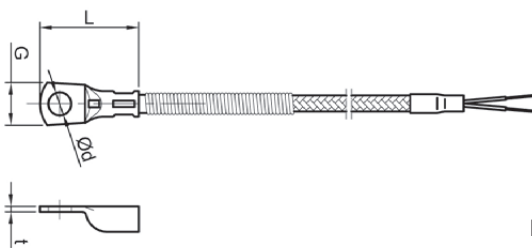

RT26

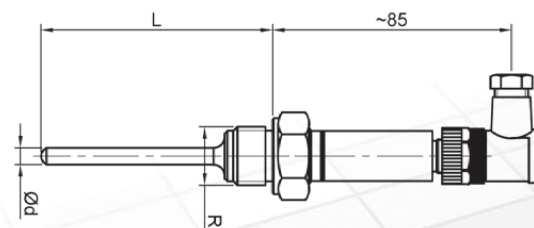

RT27

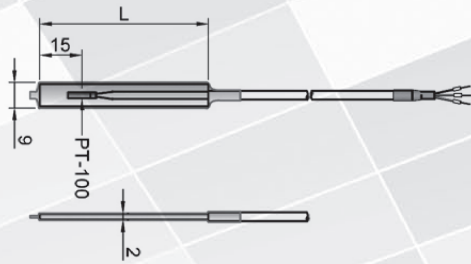

Material: Fiber

RT28

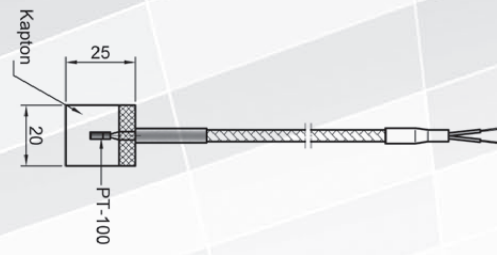

RT29

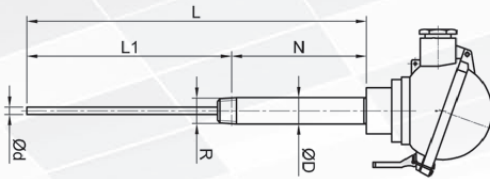

RT30-N Nipple

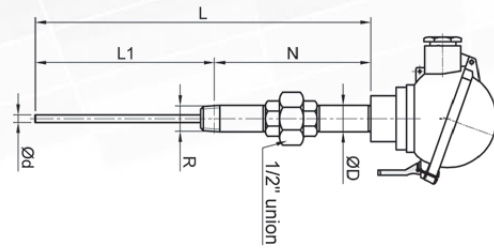

RT30-NUN Nipple-Union-Nipple

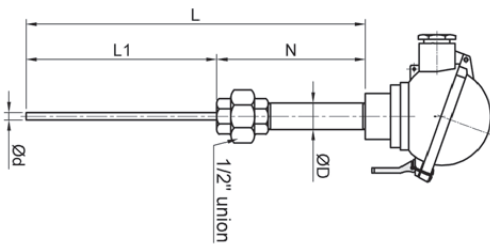

RT30-NU Nipple-Union

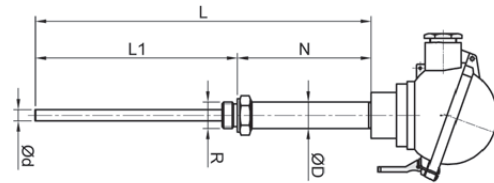

RT30-R Flat-Thread

D