

MOL

Configuration

MOL Setscrew Type
Outside Dia. $\phi 16 \sim \phi 32$

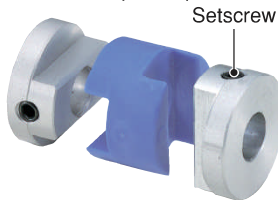

MOL-C Clamp Type
Outside Dia. $\phi 16 \sim \phi 32$

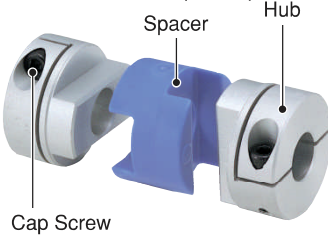

MOL Setscrew Type
Outside Dia. $\phi 40 \sim \phi 63$

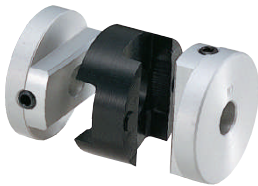

MOL-C Clamp Type
Outside Dia. $\phi 40 \sim \phi 63$



Material & Finish

Hub	A2017, Anodized Aluminum Coating
Spacer	Polyacetal
Setscrew	SCM435, Black Oxide Coating*
Cap Screw	SCM435, Black Oxide Coating*

*Stock screws can be replaced with stainless steel screws. Please take advantage of our stainless steel screw option. For more information please refer to page 16.

The protruded spacer design enables high allowable angular misalignment and minimized load on shafts.

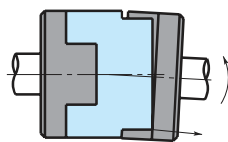
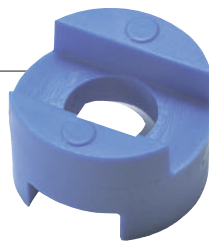

Without Protrusion

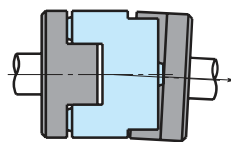

MOL
With Protrusion

Oldham coupling with no protrusions feature low allowable misalignment ($1 \sim 1.5^\circ$) due to interference between the spacer and hubs at the proximity of the outside diameter.

A bending moment is generated as well.

The MOL series features a high maximum angular misalignment (3°), enabled by the protrusions which act as points of support.

No bending moment is generated and the shaft load is minimized.

Features

Merits

- High Torque
- Small Eccentric Reaction Force
- High Allowable Misalignment
- Vibration Absorption

- Recipient of the 1991 Ministry of Economy, Trade and Industry Good Design Award
- Oldham type flexible coupling
- Slippage between hubs and spacer allows high parallel and angular misalignments
- Minimized load derived from misalignments on shafts
- Simple configuration enables ease of assembly
- Excellent electrical insulation
- Operational temperature: $-20^\circ\text{C} \sim 80^\circ\text{C}$
- Finished products featuring two different end bore diameters available in stock

Application	
Servomotor	—
Stepping Motor	●
General-purpose Motor	◎
Encoder	—
Features	
Zero Backlash	—
High Torsional Stiffness	—
High Torque	◎
Absorption of Misalignment	◎
Vibration Absorption	●
Electrical Insulation	◎
Corrosion Resistant (All Stainless Steel)	—

◎ : Excellent ● : Very Good

When Ordering

Specify product code and both bore diameters.

MOL-20-6×8

Product Code

D₁

D₂



Technical Data



Eccentric Reaction Force

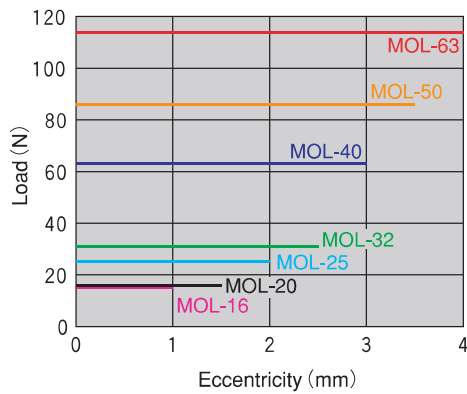

This graph indicates the initial slip load on the hub and spacer. After the component is broken in, slip load is lessened, axel load caused by misalignment is reduced, and the burden on bearings will be lightened.



Changes in Static Torsional Stiffness Caused by Temperature

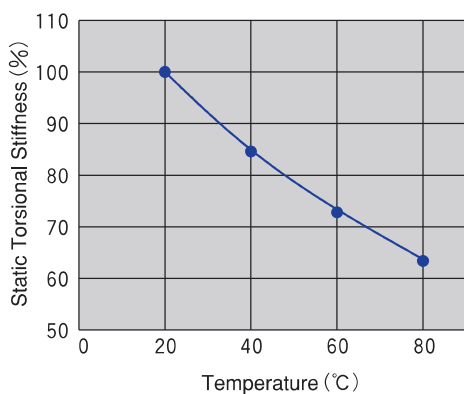

100% values represent product performance at 20°C. The graph shows the changes in torsional stiffness within the operational temperature range. Please take into consideration the decreases in response at higher temperatures.



Natural Frequency

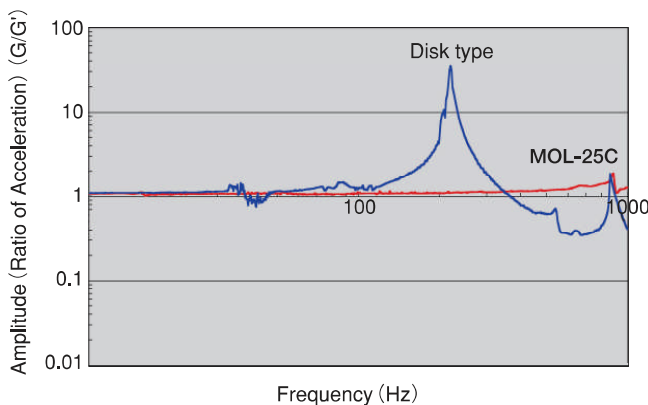

MOL has low natural frequency amplitudes and features excellent vibration absorption. *Data for all sizes can be downloaded from our homepage.

● The technical data contained in this catalog is for convenient reference, but they are not guaranteed values. More detailed technical data can be downloaded from our homepage.

MOL Setscrew Type

CAD DATA [2D](#) [3D](#)
down load

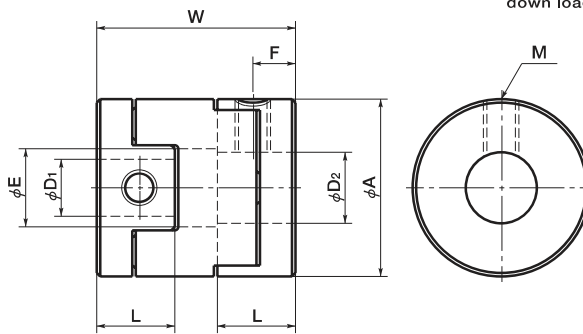

Dimensions

unit:mm

Product Code			A	L	W	E	F	G	M	Wrench Torque (N·m)
MOL-16			16	7	18	7	3,5	—	M 3	0,7
MOL-20			20	9	23	9	4,5	—	M 4	1,7
MOL-25			25	11	28	11	5,5	—	M 5	4
MOL-32			32	13	33	14,5	6,5	—	M 6	7
MOL-40			40	14	32	17	7	—	M 6	7
MOL-50			50	17	38	23	8,5	—	M 8	15
MOL-63			63	21	47	28	10,5	—	M10	30
MOL-16C			16	12,5	29	7	3	5	M 2,5	1
MOL-20C			20	14	33	9	3	6,5	M 2,5	1
MOL-25C			25	16,5	39	11	3,8	9	M 3	1,5
MOL-32C			32	19	45	14,5	4,5	11	M 4	2,5
MOL-40C			40	23	50	17	7	13	M 5	4
MOL-50C			50	27	58	23	8	16	M 6	8
MOL-63C			63	33	71	28	10	21	M 8	16

Product Code	Stock Bore Diameters															
	D1 · D2															
	3	4	5	6	6-35	8	9-525	10	11	12	14	15	16	18	20	25
MOL-16	●	●	●	●	●											
MOL-20		●	●	●	●	●										
MOL-25			●	●	●	●	●									
MOL-32						●	●		●	●						
MOL-40							●		●	●	●	●				
MOL-50										●	●	●	●	●	●	
MOL-63												●	●	●	●	●
MOL-16C			●	●												
MOL-20C				●	●	●										
MOL-25C					●	●	●									
MOL-32C						●	●	●	●	●						
MOL-40C									●	●	●	●	●			
MOL-50C												●	●	●	●	●
MOL-63C													●	●	●	●

- All products come with setscrews (MOL) or cap screws (MOL-C).
- Tolerance on shaft bores of setscrew type coupling is H8.
- Recommended tolerance on shaft diameters is h6 and h7.
- Setscrew type/clamp type and other combination couplings are available on request.
- Bore and keyway modifications are available on request. * Please take advantage of our bore modification services. For more information please refer to pages 17~19.

MOL-C Clamp Type

CAD DATA [2D](#) [3D](#)
down load

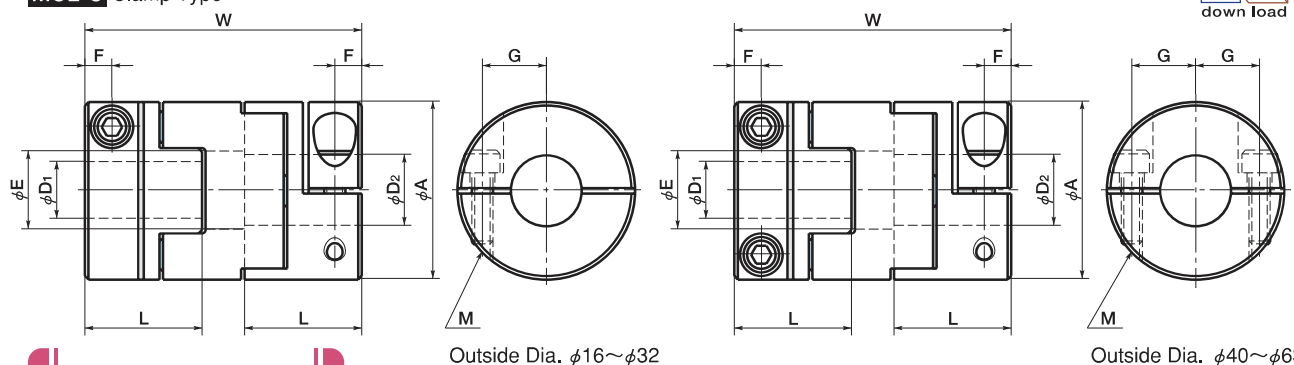

Specifications

Product Code	Max. Bore (mm)	Rated* Torque (N·m)	Max.* Torque (N·m)	Max. Rotational Frequency (min ⁻¹)	Moment of Inertia (kg·m ²)	Static Torsional Stiffness (N·m/rad)	Errors of Eccentricity (mm)	Errors of Angularity (°)	Mass** (g)
MOL-16	6,35	0,7	1,4	39000	3,2×10 ⁻⁷	31	1,0	3	7
MOL-20	8	1,2	2,4	31000	1,0×10 ⁻⁶	60	1,5	3	14
MOL-25	10	2	4	25000	3,0×10 ⁻⁶	140	2,0	3	27
MOL-32	14	4,5	9	19000	9,5×10 ⁻⁶	280	2,5	3	50
MOL-40	16	9	18	15000	2,3×10 ⁻⁵	540	3,0	3	80
MOL-50	20	18	36	12000	6,7×10 ⁻⁵	820	3,5	3	150
MOL-63	25	36	72	10000	2,2×10 ⁻⁴	1900	4,0	3	300
MOL-16C	6	0,7	1,4	39000	5,8×10 ⁻⁷	31	1,0	3	12
MOL-20C	8	1,2	2,4	31000	1,5×10 ⁻⁶	60	1,5	3	19
MOL-25C	10	2	4	25000	4,4×10 ⁻⁶	140	2,0	3	36
MOL-32C	14	4,5	9	19000	1,4×10 ⁻⁵	280	2,5	3	69
MOL-40C	16	9	18	15000	4,1×10 ⁻⁵	540	3,0	3	130
MOL-50C	20	18	36	12000	1,2×10 ⁻⁴	820	3,5	3	230
MOL-63C	25	36	72	10000	3,7×10 ⁻⁴	1900	4,0	3	450

*Adjustment of rated and maximum torque specifications for load fluctuations is not required. However, if operating temperature exceeds 30°C, please adjust rated torque and maximum torque as detailed in the table below. The operational temperature range for **MOL** is -20°C~80°C. For more detailed information, please refer to For Better Drive on page 34.

**Based on the maximum shaft bores.

Air Temperature	Temperature Correction Factor
-20°C~30°C	1,00
30°C~40°C	0,80
40°C~60°C	0,70
60°C~80°C	0,55

● We also manufacture a compact oldham type coupling **MOS**.



MOS (P.106~P.108)