

PS001V-301-2UPN8X-H1141

Pressure sensor – 2 PNP/NPN Transistor Switching Outputs

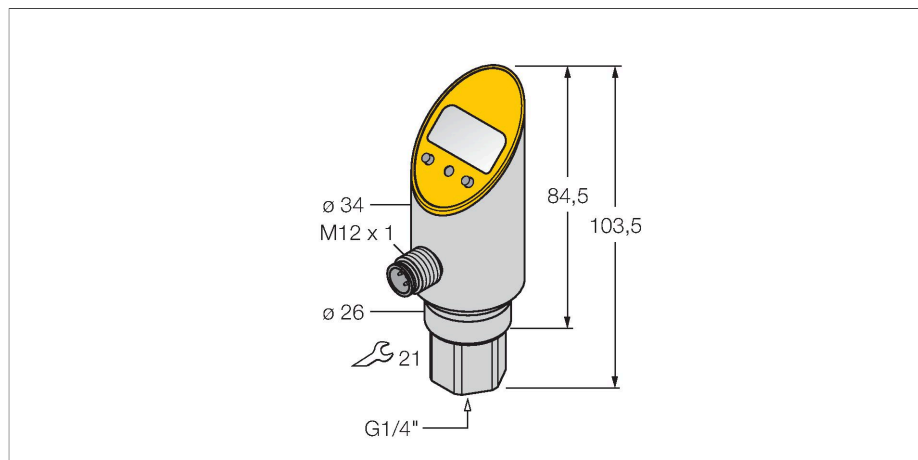

Features

- Rigid process connection, non-rotatable body
- Reading of adjusted values without tool
- Recessed pushbutton and keylock for secure programming
- Permanent indication of pressure (bar, psi, kPa, MPa, misc)
- Peak pressure memory
- Pressure range -1...1 bar rel.

Wiring diagram

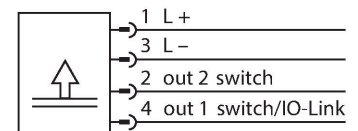

Technical data

| | |
|---|----------------------------------|
| Type | PS001V-301-2UPN8X-H1141 |
| ID | 6833314 |
| Medium temperature | -40...+85 °C |
| Pressure range | |
| Pressure type | Relative pressure |
| Pressure range | -1...1 bar |
| | -14.5...14.5 psi |
| | -0.1...0.1 MPa |
| Admissible overpressure | ≤ 5.5 bar |
| Burst pressure | ≥ 5.5 bar |
| Response time | < 3 ms |
| Power supply | |
| Operating voltage | 18...30 VDC |
| Current consumption | ≤ 50 mA |
| Protective measure | SELV; PELV according to EN 50178 |
| Short-circuit/reverse polarity protection | yes / yes |
| Insulation class | III |
| Outputs | |
| Output 1 | Switching output or IO-Link mode |
| Output 2 | Switching output |
| Switching output | |
| Communication protocol | IO-Link |
| Output function | NO/NC, PNP/NPN |
| Accuracy | ± 0.5 % FS BSL |
| Rated operational current | 0.2 A |
| Switching frequency | ≤ 180 Hz |
| Switching point distance | ≥ 0.5 % |

Functional principle

The pressure sensors in the PS product series operate with ceramic measuring cells. As a result of the pressure acting on the ceramic substrate, a signal that is proportional to the pressure is generated and processed electronically. The processed signal is available either as a switching or an analog output signal, depending on the sensor type used. Maximum flexibility thanks to a rigid or rotatable sensor body, a variety of thread types, front-flush or dead-space-free pressure membranes and an accuracy of 0.5 % of full scale guarantee a safe connection to the process.

Technical data

| | |
|---|---|
| Switch point: | (Min. + 0.005 × range)...100 % of full scale |
| Release point(s) | min up to (SP - 0.005 x range) |
| Switching cycles | ≥ 100 mil. |
| IO-Link | |
| IO-Link specification | V 1.0 |
| Transmission physics | corresponds to 3-wire physics (PHY2) |
| Frame type | 2.2 |
| Transmission rate | COM 2 / 38.4 kbps |
| Process data width | 16 bit |
| Measured value information | 14 bit |
| Switchpoint information | 2 bit |
| Programming | FDT / DTM |
| Accuracy | ± 0.5 % FS BSL |
| Included in the SIDI GSDML | Yes |
| Programming options | switch/release point, PNP/NPN; NO/NC; hysteresis/window mode, muting; pressure unit, peak pressure memory |
| Housing material | Stainless-steel/Plastic, 1.4305 (AISI 303) |
| Process connection | G 1/4" female thread |
| Pressure connection material | Stainless steel 1.4305 (AISI 303) |
| Pressure transducer material | Ceramic Al ₂ O ₃ |
| Sealing material | FPM spez. |
| Wrench size pressure connection / coupling nut | 21 |
| Max. tightening torque of housing nut | 35 Nm |
| Electrical connection | Connector, M12 × 1 |
| Protection class | IP67 IP69K |
| Ambient temperature | -40...+80 °C |
| Storage temperature | -40...+80 °C |
| Shock resistance | 50 g (11 ms) , acc. to IEC 68-2-27 |
| Vibration resistance | 20 g (9...2000 Hz), according to IEC 68-2-6 |
| EMV | EN 61000-4-2 ESD:4 kV CD / 8 kV AD EN 61000-4-3 HF radiated: 15 V/m EN 61000-4-4 Burst: 2 kV EN 61000-4-5 Surge: 1000 V, 42 Ohm EN 61000-4-6 HF cable bound: 10 V |
| Tests/approvals | |
| UL registration number | E183243 |
| Reference conditions acc. to IEC 61298-1 | |
| Temperature | 15...+25 °C |
| Atmospheric pressure | 860...1060 hPa abs. |

Technical data

| | |
|---|---|
| Humidity | 45...75 % rel. |
| Auxiliary power | 24 VDC |
| Display | 4-digit 7-segment display, rotatable by 180°, disengageable |
| Switching state | 2 × LEDs, Yellow |
| Unit display | 5 x LEDs green (bar, psi, kPa, MPa, misc) |
| Temperature behaviour | |
| Temperature coefficient span T_{KS} | ± 0.3 % of full scale/10 K |
| Temperature coefficient zero point T_{K0} | ± 0.3 % of full scale/10 K |
| MTTF | 242 years acc. to SN 29500 (Ed. 99) 40 °C |

Technical data

| | |
|---|----------------------------------|
| Type | PS001V-301-2UPN8X-H1141 |
| ID | 6833314 |
| Pressure range | |
| Pressure type | Relative pressure |
| Pressure range | -1...1 bar |
| | -14.5...14.5 psi |
| | -0.1...0.1 MPa |
| Admissible overpressure | ≤ 5.5 bar |
| Burst pressure | ≥ 5.5 bar |
| Response time | < 3 ms |
| Power supply | |
| Operating voltage | 18...30 VDC |
| Current consumption | ≤ 50 mA |
| Voltage drop at I_o | ≤ 2 V |
| Protective measure | SELV; PELV according to EN 50178 |
| Short-circuit/reverse polarity protection | yes / yes |
| Protection type and class | IP67 IP69K / III |
| Outputs | |
| Output 1 | Switching output or IO-Link mode |
| Output 2 | Switching output |
| Switching output | |
| Communication protocol | IO-Link |
| Output function | NO/NC, PNP/NPN |
| Accuracy | ± 0.5 % FS BSL |
| Rated operational current | 0.2 A |
| Switching frequency | ≤ 180 Hz |
| Switching point distance | ≥ 0.5 % |

Technical data

| | |
|--|---|
| Switch point: | (Min. + 0.005 × range)...100 % of full scale |
| Release point(s) | min up to (SP - 0.005 x range) |
| Switching cycles | ≥ 100 mil. |
| IO-Link | |
| IO-Link specification | V 1.0 |
| Programming | FDT / DTM |
| Transmission physics | corresponds to 3-wire physics (PHY2) |
| Transmission rate | COM 2 / 38.4 kbps |
| Process data width | 16 bit |
| Measured value information | 14 bit |
| Switchpoint information | 2 bit |
| Frame type | 2.2 |
| Accuracy | ± 0.5 % FS BSL |
| Included in the SIDI GSDML | Yes |
| Temperature behaviour | |
| Medium temperature | -40...+85 °C |
| Temperature coefficient zero point T _{k0} | ± 0.3 % of full scale/10 K |
| Temperature coefficient span T _{ks} | ± 0.3 % of full scale/10 K |
| Ambient conditions | |
| Ambient temperature | -40...+80 °C |
| Storage temperature | -40...+80 °C |
| Vibration resistance | 20 g (9...2000 Hz), according to IEC 68-2-6 |
| Shock resistance | 50 g (11 ms) , acc. to IEC 68-2-27 |
| EMV | EN 61000-4-2 ESD:4 kV CD / 8 kV AD EN 61000-4-3 HF radiated: 15 V/m EN 61000-4-4 Burst: 2 kV EN 61000-4-5 Surge: 1000 V, 42 Ohm EN 61000-4-6 HF cable bound: 10 V |
| Mechanical data | |
| Housing material | Stainless-steel/Plastic, 1.4305 (AISI 303) |
| Pressure connection material | Stainless steel 1.4305 (AISI 303) |
| Pressure transducer material | Ceramic Al ₂ O ₃ |
| Sealing material | FPM spez. |
| Process connection | G 1/4" female thread |
| Wrench size pressure connection / coupling nut | 21 |
| Electrical connection | Connector, M12 × 1 |
| Max. tightening torque of housing nut | 35 Nm |
| Reference conditions acc. to IEC 61298-1 | |
| Temperature | 15...+25 °C |
| Atmospheric pressure | 860...1060 hPa abs. |

Technical data

| | |
|------------------------|---|
| Humidity | 45...75 % rel. |
| Auxiliary power | 24 VDC |
| Display | 4-digit 7-segment display, rotatable by 180°, disengageable |
| Switching state | 2 × LEDs, Yellow |
| Unit display | 5 x LEDs green (bar, psi, kPa, MPa, misc) |
| Programming options | switch/release point, PNP/NPN; NO/NC; hysteresis/window mode, muting; pressure unit, peak pressure memory |
| Tests/approvals | |
| Approvals | cULus |
| UL registration number | E183243 |
| MTTF | 242 years acc. to SN 29500 (Ed. 99) 40 °C |

Accessories

| | |
|-----------|-------|
| PTS-COVER | A9350 |
|-----------|-------|

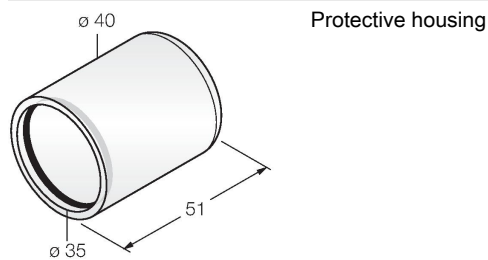

Accessories

| Dimension drawing | Type | ID | |
|-------------------|---------------|---------|--|
| | WKC4.4T-2/TEL | 6625025 | Connection cable, female M12, angled, 4-pin, cable length: 2 m, sheath material: PVC, black; cULus approval; other cable lengths and qualities available, see www.turck.com |
| | RKC4.4T-2/TEL | 6625013 | Connection cable, female M12, straight, 4-pin, cable length: 2 m, sheath material: PVC, black; cULus approval; other cable lengths and qualities available, see www.turck.com |

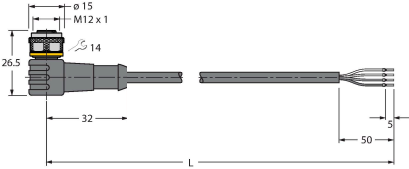
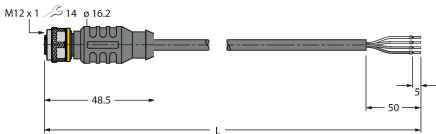
| Dimension drawing | Type | ID | |
|---|---------------------|---------|--|
|  <p>Technical drawing of the RKC4.4T-2/TXL cable. It shows a female M12 connector with a diameter of 15mm and a length of 11.5mm. The cable length is 2m (L). The drawing also indicates a 14mm distance from the connector to the start of the cable sheath and a 50mm distance from the end of the cable to the start of the sheath.</p> | RKC4.4T-2/TXL | 6625503 | Connection cable, female M12, straight, 4-pin, cable length: 2 m, sheath material: PUR, black; cULus approval; other cable lengths and qualities available, see www.turck.com |
|  <p>Technical drawing of the WKC4.4T-2/TXL cable. It shows an angled female M12 connector with a diameter of 15mm and a length of 26.5mm. The cable length is 2m (L). The drawing also indicates a 14mm distance from the connector to the start of the cable sheath and a 50mm distance from the end of the cable to the start of the sheath.</p> | WKC4.4T-2/TXL | 6625515 | Connection cable, female M12, angled, 4-pin, cable length: 2 m, sheath material: PUR, black; cULus approval; other cable lengths and qualities available, see www.turck.com |
|  <p>Technical drawing of the RKC4.4T-P7X2-10/TXL cable. It shows a female M12 connector with a diameter of 15mm and a length of 48.5mm. The cable length is 10m (L). The drawing also indicates a 14mm distance from the connector to the start of the cable sheath and a 50mm distance from the end of the cable to the start of the sheath.</p> | RKC4.4T-P7X2-10/TXL | 6626184 | Connection cable, female M12, angled, 4-pin, cable length: 10m, sheath material: PUR, black; cULus approval; other cable lengths and qualities available, see www.turck.com |

Accessories

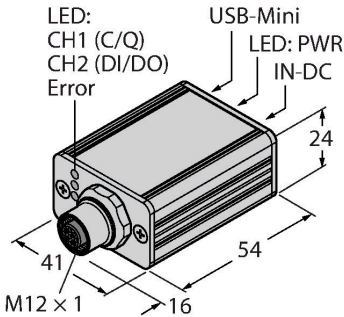
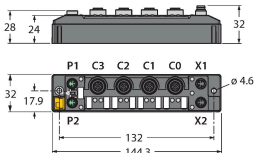
| Dimension drawing | Type | ID | |
|--|----------------|---------|--|
|  <p>Technical drawing of the USB-2-IOL-0002 module. It is a rectangular module with dimensions 41mm (width), 54mm (depth), and 24mm (height). It features an M12 x 1 connector on the front. Labels include: LED: CH1 (C/Q), CH2 (DI/DO), Error; USB-Mini; LED: PWR; and IN-DC.</p> | USB-2-IOL-0002 | 6825482 | IO-Link Master with integrated USB port |
|  <p>Technical drawing of the TBEN-S2-4IOL module. It is a compact module with dimensions 132mm (width) and 144.3mm (depth). It features a P1 connector, four digital channels (C3, C2, C1, C0), and an X1 connector. Other labels include P2 and X2.</p> | TBEN-S2-4IOL | 6814024 | Compact multiprotocol I/O module, 4 IO-Link Master 1.1 Class A, 4 universal PNP digital channels 0.5 A |