

Technical data sheet

Actuator sensor interface · M12 - cables

Female M12 angled with PUR cable, shielded 360°, open end
Self-locking screw connection
C-track compatible, halogen free



Identification

Type K UW8-M12(C) 5M PUR
Part No. [458905](#)

Product version

Datasheet version 00

Use/Application/Properties

Properties

- Silicone free
- Free from paint wetting disruptive substances (LABS-free)
- Hydrolysis-resistant, microbe-resistant, and rot-resistant
- Resistance to acids, alkalines and watery solutions

General

Design	M 12×1
Form male 1	M 12 female angle connector
Form male 2	line end open
Rated insulation voltage	36 V
Test voltage	1500 V
Degree of pollution	3
Contact resistance	<5 mΩ
Flamability according to UL 94	HB
Degree of protection	IP65/67
Housing material	TPU
Color of the housing	black
Contact material	CuSn, gold-plated

United Kingdom: LÜTZE Ltd.

Unit 3, Sandy Hill Park
Sandy Way, Amington · GB-Tamworth, Staffs B77 4DU
Tel. +44 (0)1827 31333-0 · Fax +44 (0)1827 31333-2
www.lutze.com · sales.gb@lutze.co.uk

Germany: Friedrich Lütze GmbH

Postfach 12 24 (PLZ 71366) · Bruckwiesenstraße 17-19 · D-71384 Weinstadt
Tel. +49 (0)7151 6053-0 · Fax +49 (0)7151 6053-277(-288)
www.luetze.de · info@luetze.de

03.05.2022 · Subject to technical modification

Part No. [458905](#) · Datasheet version: 00

page 1 of 4



SYSTEMATIC TECHNOLOGY

Technical data sheet

Actuator sensor interface · M12 - cables

Dimensions

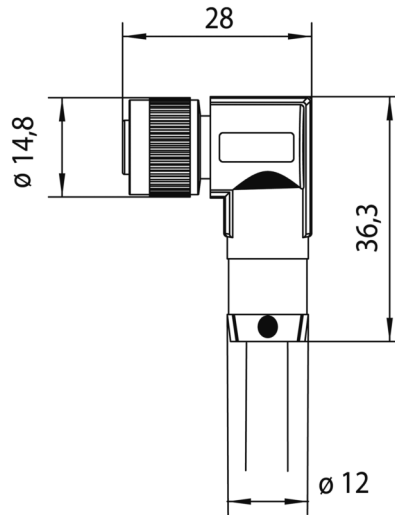

Action chart

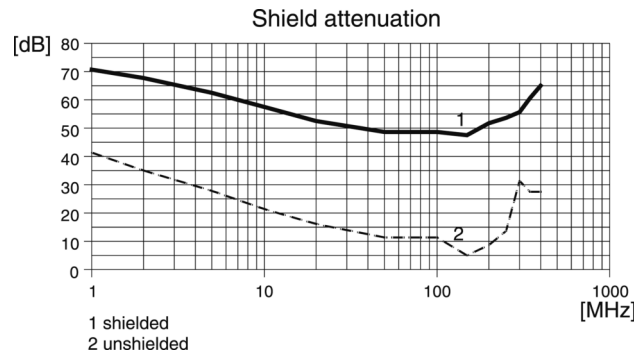

Pin layout

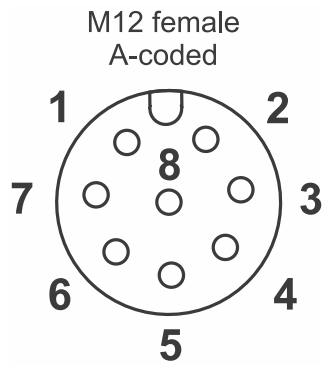

Technical data sheet

Actuator sensor interface · M12 - cables

Circuit diagram

