

## ■ PRO-10 PB | Portable Pipe Beveller



PRO-10 PB is a heavy duty pipe Beveller designed for portable use in pipe machining operations. Self-centering expandable mandrels provide quick and proper alignment to a pipe or a tube prior to machining operations.

PRO-10 PB is able to bevel, face off, ID chamfer, counterbore and J-beveling, making all these weld prep operations quick and simple.

Depending on users preferences and on site conditions PRO-10 PB machine can be operated with a high quality powerful pneumatic motor or top quality high torque electric motor.

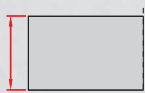
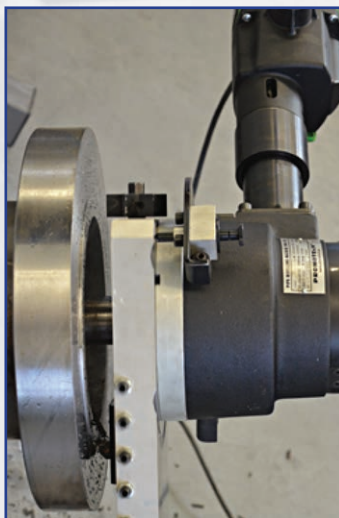
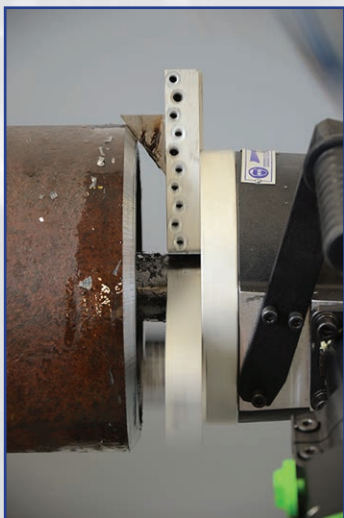

Max. wall  
thickness 15 mm



ID 84-269 mm  
38-84 mm (option)  
or 270-349 mm (option)



Facing off



Pipe OD  
beveling



Pipe ID  
beveling



J-groove beveling  
(option)

# PRO 10-PB Capacities at a Glance

Wide range of accessories for multiple applications including flange facing and oval beveling.  
PRO-10 PB can be equipped with optional accessories according to customers' needs and preferences.

**EXTENSION SETS**  
for pipe ID range  
38-84 mm & 270-349 mm

**ATTACHMENTS**  
for  
oval pipe & flange facing

**ELECTRIC & PNEUMATIC**  
heavy-duty motors  
available

Technical specifications	PRO-10 PB with electric motor	PRO-10 PB with pneumatic motor
Electric motor	1.8 kW	-
Supply	110-120 V / 50-60 Hz or 220-240 V / 50-60 Hz	-
Rotational speed (nominal)	gear 1-12 to 29 rpm	-
	gear 2-41 to 96 rpm	-
Pneumatic drive	-	1,8 kW
Air requirement	-	0,6 MPa
Air consumption	-	1750 NI/min
Rotational speed (without load)	-	17 rpm
Rotational speed (nominal)	-	9 rpm
Min ID	84 mm (3.31"); 38 mm - option	84mm (3.31"); 38mm - option
Max ID	269 mm (10.59"); 349 mm (13.74") - option	269 mm (10.59"); 349 mm (13.74") - option
Max OD	273 mm (10.75"); 355 mm (13.98") - option	273 mm (10.75"); 355 mm (13.98") - option
Max. wall thickness	15 mm (0.59")	15 mm (0.59")
Weight (incl. motor)	35.9 kg (79 lbs)	33 kg (73 lbs)

## Dimensions

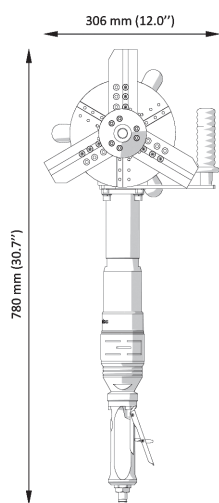
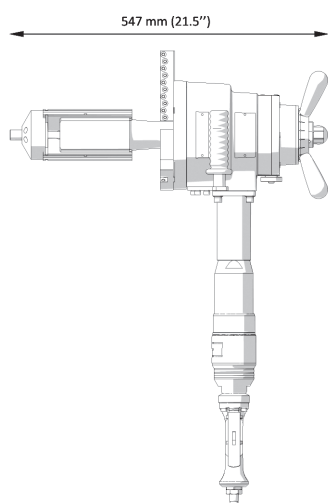

PRO-10 PB with pneumatic motor

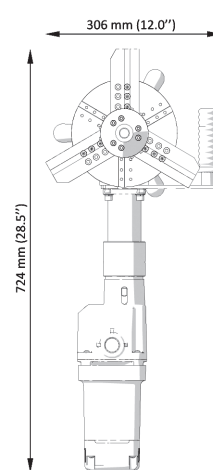
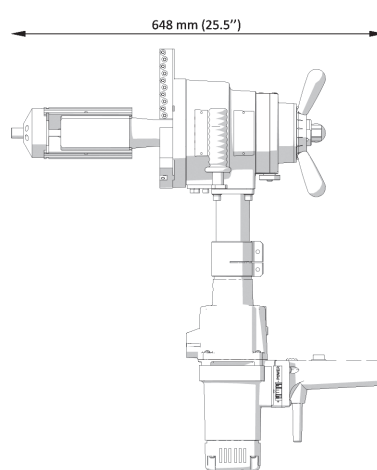

PRO-10 PB with electric motor

## Standard shipping set:

- PRO-10 PB (without motor, tool bits)
- Metal box
- Standard self-centering expandable mandrel for pipe ID  $\varnothing$  84 – 269 mm (3.31 – 10.59")
- Jaw blocks (1,2,3,4,5,6) and adapter – 3 sets
- Set of tools
- Coolant container
- Operator's manual

Product code: UKS-0200-10-00-01-1





## OPTIONAL ACCESSORIES



Electric motor 230 V  
Product Code: SLN-000094

Electric motor 115 V US plug  
Product Code: SLN-000102

Electric motor 115 V UK plug  
Product Code: SLN-000120



Pneumatic motor  
Product Code: SLN-0200-15-00-00-0

Connection set for electric motor  
Product Code: ZST-0200-99-01-00-0

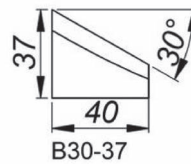
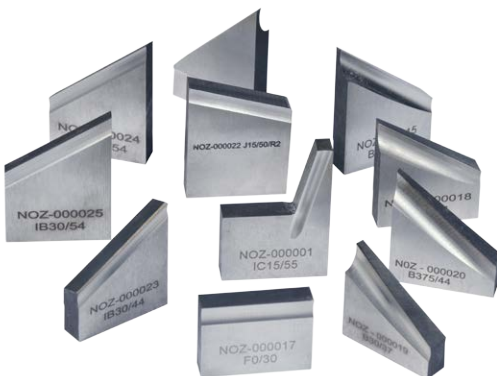

30° Beveling Tool Bit,  
Height 37 mm [B30/37]  
Product Code: NOZ-000019

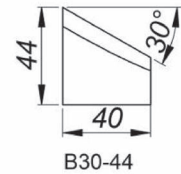

30° Beveling Tool Bit,  
Height 44 mm [B30/44]  
Product Code: NOZ-000018

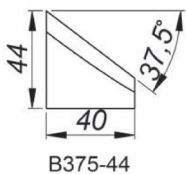

37.5° Beveling Tool Bit,  
Height 44 mm [B375/44]  
Product Code: NOZ-000020

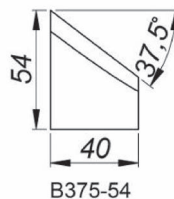

37.5° Beveling Tool Bit,  
Height 54 mm [B375/54]  
Product Code: NOZ-000015

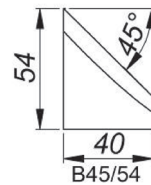

45° Beveling Tool Bit,  
Height 54 mm [B45/54]  
Product Code: NOZ-000021

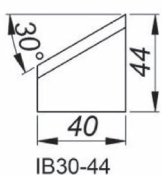

30° Internal Beveling Tool Bit,  
Height 44 mm [IB30/44]  
Product Code: NOZ-000023

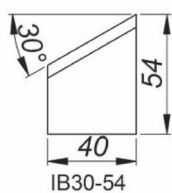

30° Internal Beveling Tool Bit,  
Height 54 mm [IB30/54]  
Product Code: NOZ-000025

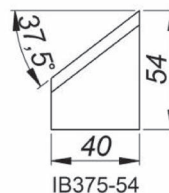

37.5° Internal Beveling Tool  
Bit, Height 54 mm [IB375/54]  
Product Code: NOZ-000024

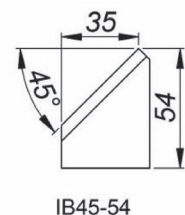

45° Internal Beveling Tool  
Bit, Height 54 mm [IB45/54]  
Product Code: NOZ-000026

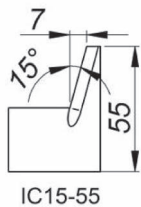

15° Internal Calibration Tool Bit, Height 55 mm [IC15/55]  
Product Code: NOZ-000001

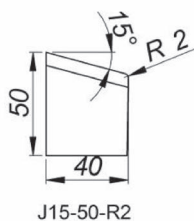

15° J-Beveling Tool Bit, Height 50 mm, Radius 2mm [J15/50/R2]  
Product Code: NOZ-000022

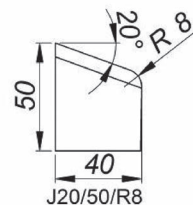

20° J-Beveling Tool Bit, Height 50 mm, Radius 8mm [J20/50/R8]  
Product Code: NOZ-000016

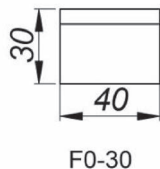

Facing Tool Bit, Height 30 mm [F0/30]  
Product Code: NOZ-000017

Custom made versions of tool bits are available on request.  
Tool bits could also be coated to increase their durability



Small expanding mandrel set incl. jaws I, II, III, IV for pipe ID Ø 38 – 86 mm (1.5 to 3.39")  
Product Code: ZSP-0200-05-00-00-2



Extension set for OD Ø up to 355 mm (14") incl. 3 steel tool holders and jaws 7, 8, 9, 10, 11  
Recommended for pipe wall thickness up to 7 mm (0.26")  
Product Code: ZST-0200-13-00-00-2



Large expanding mandrel for pipe ID Ø 126 – 296 mm (5 to 11.65") with standard jaws, and pipe ID Ø 219 – 376 mm (8.62 to 14.80") with optional extension set  
Product Code: TRZ-0200-99-00-00-0

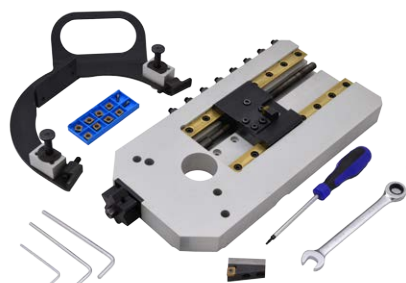

Flange facing attachment  
Product Code: PRK-0447-00-00-00-2

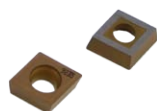

Flange facing insert  
P.Code: PLY-000210

Flange diameter	90–508 mm (3.54–20")
Automatic feed range	180.5 mm (7.11")
Diameter of rotating parts	569.4 mm (22.42")
Pipe ID	84–269mm (3.31–10.59") using the standard expanding mandrel 219–376 mm (8.62–13.74") using the large expanding mandrel
Feed per rotation	0.33 mm (0.013", with one tripper block engaged) 0.66 mm (0.026", with two tripper blocks engaged)



Oval attachment set incl. large mandrel for pipe ID Ø 126 – 296 mm (5 to 11-5/8")  
Product Code: PRK-0463-00-00-00-1



Air preparation set  
Product Code: ZST-000021



PROMOTECH Sp. z o.o.  
ul. Elewatorska 23/1, 15-620 BIAŁYSTOK, POLAND  
tel. (+48 85) 678 34 05, fax (+48 85) 662 78 77  
marketing@promotech.eu www.promotech.eu

Your local dealer:



Tuurschipper 118 2292 JE Wateringen telefoon: 0174 226 226 telefax: 0174 – 225 220 e-mail: info@hatek.nl www.hatek.nl  
De Coronijn 75d 1689 AN Zwaag telefoon: 0229-212 334 telefax: 0229-246 979 e-mail: jpm@hatek.nl www.hatek.nl