

Achtung ! Kopie
nicht maßstäblich !

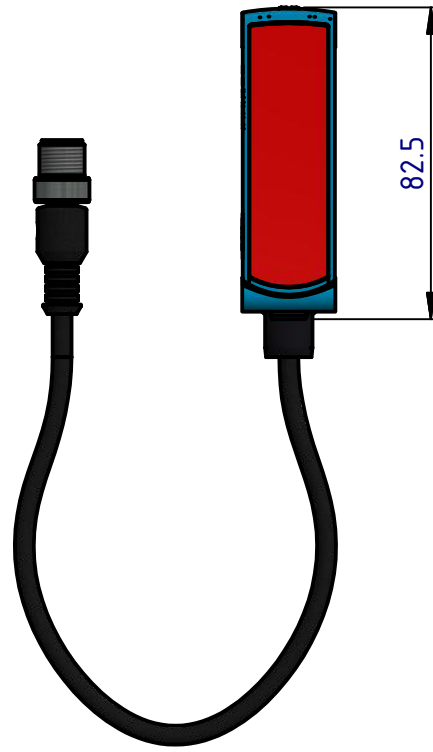

0°

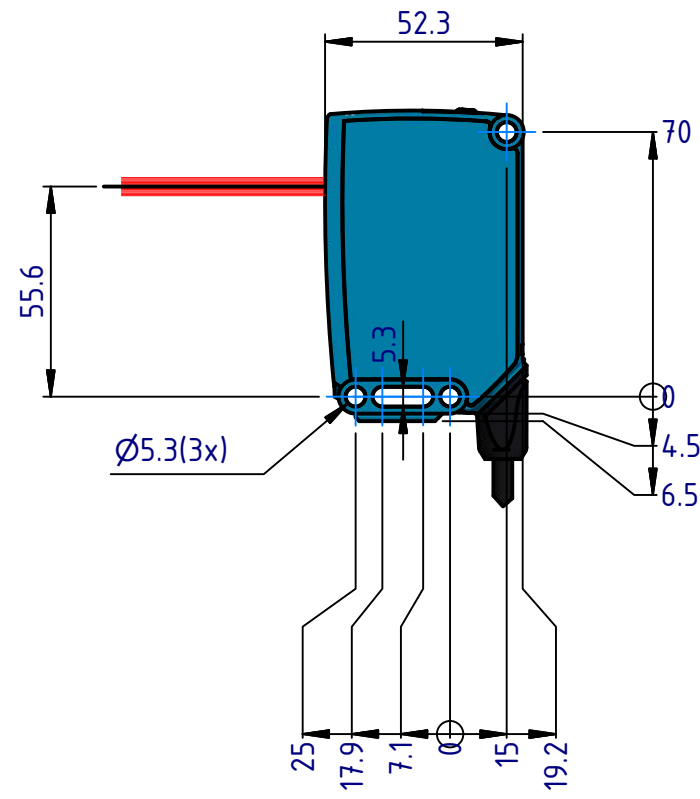
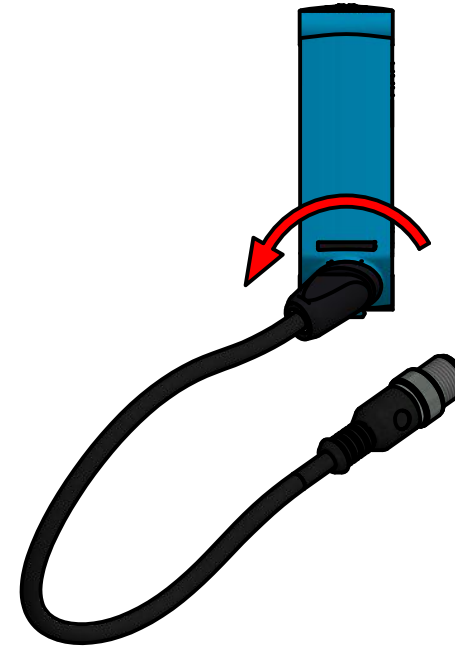

90°

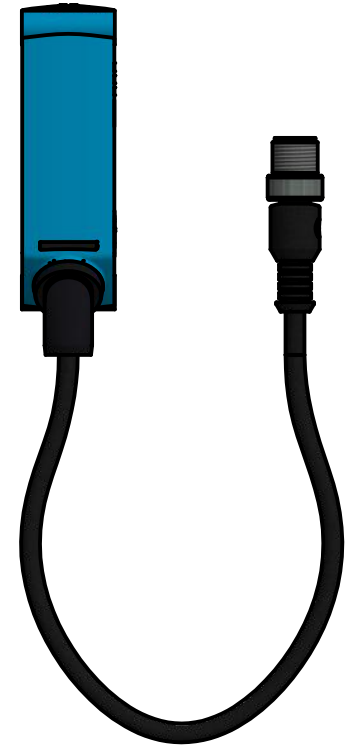

180°

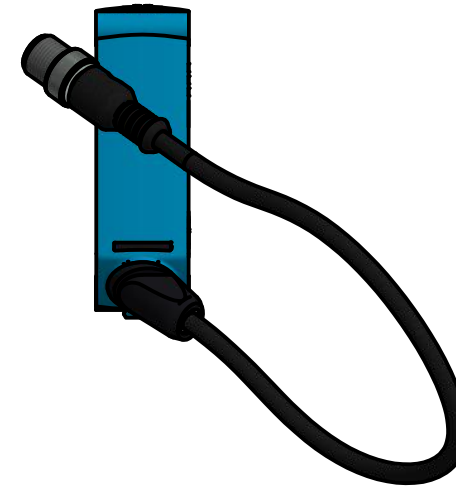

270°

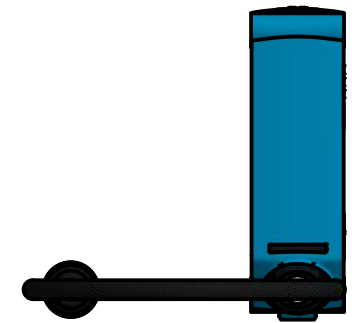

Schutzvermerk nach
DIN 34 / DIN ISO 16016

protection mark according
to DIN 34 / DIN ISO 16016

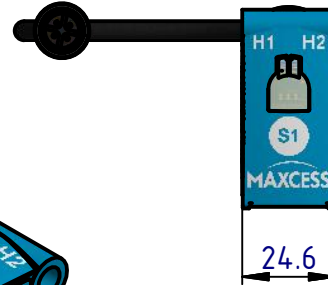
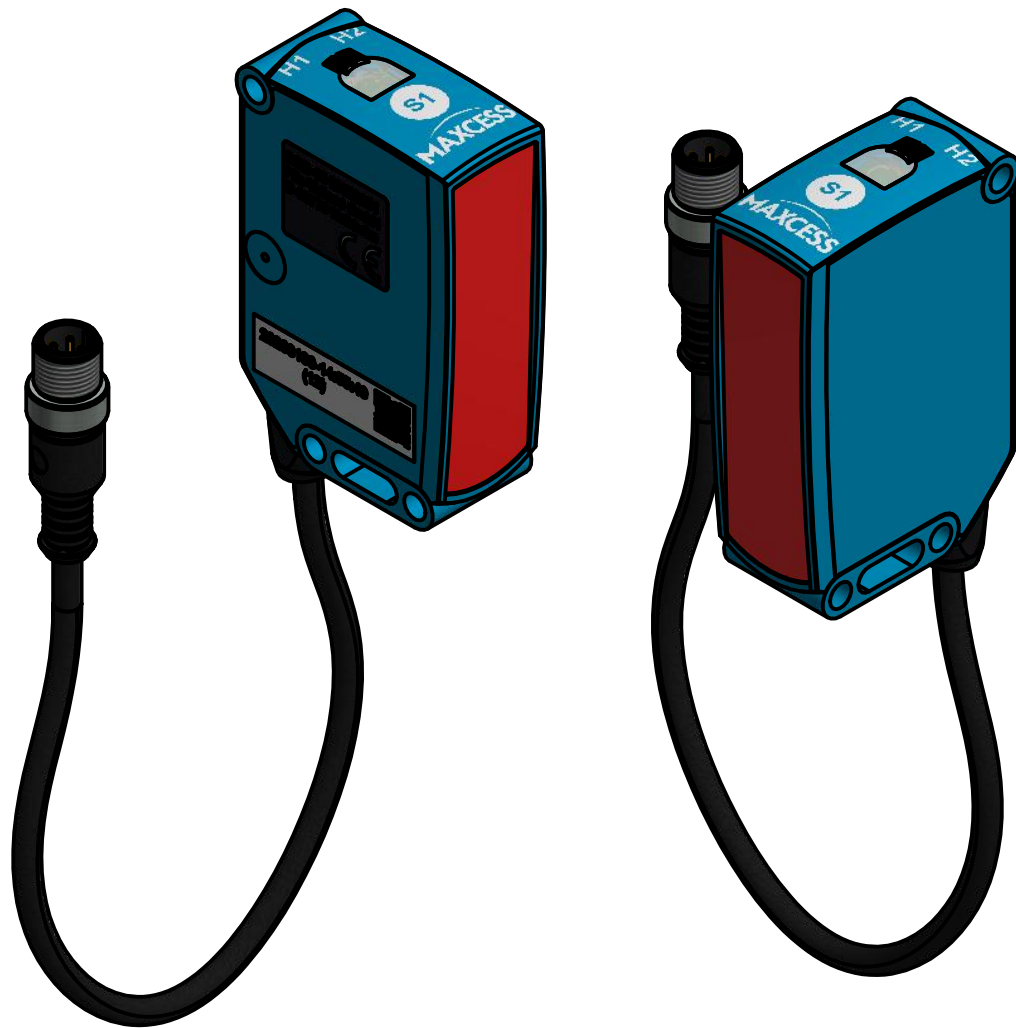

Zulässige Abweichung nach
DIN ISO 2768 T1 -m-
DIN ISO 2768 T2 -K-
Oberflächentoleranz nach
DIN ISO 1302



Benennung
REFLEXLICHTSENSOR
DSE-15 MIT KABEL
L= 0,3m

Blatt
1/1

Referenz-Zeichnung	Gewicht	Format	Maßstab	Maßeinheit	Key	Teilenummer	Zeichnungsnummer	Index
	-	A3	1 : 2	mm		M452951	807311	002
CAD-System	Projektion	Bearb.	Gepr.		001	Tastensymbol geändert		23.09.2019
IV2018		13.06.2019		ftrillin	002	Änderung der Position des Typenschildes		21.04.2020