

User Manual

PC Cards cifX

PCI (CIFX 50-XX, CIFX 50-2XX, CIFX 50-2XX\XX)

PCI Express (CIFX 50E-XX)

Low Profile PCI Express (CIFX 70E-XX, CIFX 100EH-RE\CUBE)

Installation, Operation and Hardware Description

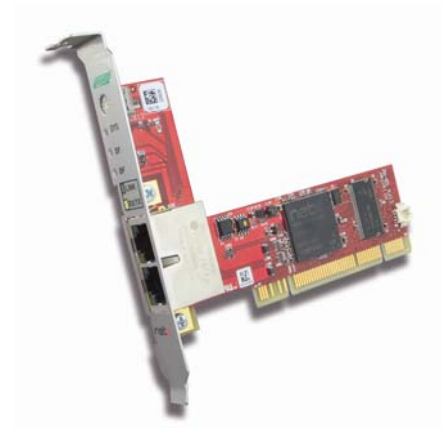

Hilscher Gesellschaft für Systemautomation mbH

www.hilscher.com

DOC120204UM46EN | Revision 46 | English | 2015-12 | Released | Public

Table of Contents

1	INTRODUCTION.....	8
1.1	About the User Manual.....	8
1.1.1	List of Revisions.....	9
1.1.2	Notes on Hardware, Firmware, Software and Driver Versions.....	10
1.1.3	Conventions in this Manual.....	13
1.1.4	Used Terminology.....	13
1.2	Contents of the Product DVD.....	14
1.2.1	Installation Guide, Documentation Overview.....	14
1.2.2	What's New.....	14
1.2.3	Important Changes.....	14
1.2.4	Device Description Files PC Cards cifX.....	17
1.3	Legal Notes.....	18
1.3.1	Copyright.....	18
1.3.2	Important Notes.....	18
1.3.3	Exclusion of Liability.....	19
1.3.4	Warranty.....	19
1.3.5	Export Regulations.....	20
1.3.6	Registered Trademarks.....	20
1.3.7	EtherCAT Disclaimer.....	21
1.3.8	Obligation to read and understand the Manual.....	21
1.4	Licenses.....	21
1.4.1	License Note about VARAN Client.....	21
2	SAFETY.....	22
2.1	General Note.....	22
2.2	Intended Use.....	22
2.3	Personnel Qualification.....	23
2.4	Safety Instructions to avoid Personal Injury.....	23
2.4.1	Electrical Shock Hazard.....	23
2.5	Safety Instructions to avoid Property Damage.....	24
2.5.1	Device Destruction by exceeding allowed Supply Voltage.....	24
2.5.2	Device Destruction by exceeding allowed Signaling Voltage.....	25
2.5.3	Electrostatically sensitive Devices.....	25
2.6	Labeling of Safety Messages.....	26
2.7	References Safety.....	26
3	DESCRIPTIONS AND REQUIREMENTS.....	27
3.1	Description.....	27
3.2	PC Cards PCI CIFX 50-XX.....	27
3.3	PC Cards PCI (2 Channels) CIFX 50-2XX, CIFX 50-2XX\XX.....	28
3.4	PC Cards PCI Express CIFX 50E-XX, CIFX 70E-XX, CIFX 100EH-RE\CUBE.....	28

3.5	The Function „Slot Number (Card ID)“.....	29
3.6	The Function „DMA Mode“	31
3.7	PC Cards cifX with additional MRAM	32
3.8	System Requirements	33
3.8.1	Slot for the PC Cards cifX PCI, PCIe and Low Profile PCIe	33
3.8.2	Power Supply and Host Interface.....	34
3.8.3	Operating Temperature Range for UL Certificate	34
3.9	Requirements for Operation of the PC Card cifX.....	35
3.10	Prerequisites for Certification.....	36
3.10.1	PROFINET IO Certification for IRT and SYNC0 Signal	36
4	GETTING STARTED.....	37
4.1	Installation and Configuration PC Card cifX	37
4.2	Note on Exchange Service (Replacement Case)	40
4.3	Notes for the Configuration of the Master Device	40
4.4	Device Names in SYCON.net.....	42
4.5	Update for Firmware, Driver and Software	44
5	DEVICE DRAWINGS	45
5.1	PC Cards cifX PCI and PCI Express	45
5.1.1	CIFX 50-RE, CIFX 50-RE\ET, CIFX 50E-RE, CIFX 50E-RE\ET	45
5.1.2	CIFX 50-DP, CIFX 50E-DP	47
5.1.3	CIFX 50-2DP	49
5.1.4	CIFX 50-2DP\CO.....	50
5.1.5	CIFX 50-2DP\DN.....	51
5.1.6	CIFX 50-CO, CIFX 50E-CO	52
5.1.7	CIFX 50-2CO.....	54
5.1.8	CIFX 50-2CO\DN.....	55
5.1.9	CIFX 50-DN, CIFX 50E-DN.....	56
5.1.10	CIFX 50-2DN	58
5.1.11	CIFX 50-2ASM, CIFX 50E-2ASM.....	59
5.1.12	CIFX 50-CC, CIFX 50E-CC.....	61
5.1.13	Meaning of the Front Panel Inscriptions for 2 Channel Devices	62
5.2	PC Cards cifX Low Profile PCI Express	63
5.2.1	CIFX 70E-RE, CIFX 70E-RE\MR	63
5.2.2	CIFX 100EH-RE\CUBE	65
5.2.3	CIFX 70E-DP, CIFX 70E-DP\MR	66
5.2.4	CIFX 70E-CO, CIFX 70E-CO\MR	68
5.2.5	CIFX 70E-DN, CIFX 70E-DN\MR.....	70
6	HARDWARE INSTALLATION AND UNINSTALLING	72
6.1	Safety Messages on Personal Injury	72
6.1.1	Electrical Shock Hazard	72
6.2	Property Damage Messages	73
6.2.1	Device Destruction by exceeding allowed Supply Voltage	73

6.2.2	Device Destruction by exceeding allowed Signaling Voltage	73
6.2.3	Electrostatically sensitive Devices.....	73
6.3	Fix Front Plate Sticker	74
6.3.1	Fix Front Plate Sticker at CIFX 50-RE, CIFX 50-RE\ET, CIFX 50E-RE and CIFX 50E-RE\ET	74
6.3.2	Fix Front Plate Sticker at CIFX 70E-RE, CIFX 70E-RE\MR, CIFX 100EH-RE\CUBE.....	75
6.4	Installing PC Card cifX PCI, PCIe, Low Profile PCIe	77
6.5	Uninstalling the PC Card cifX PCI, PCIe, Low Profile PCIe.....	78
7	TROUBLESHOOTING	79
7.1	Instructions for Problem Solving	79
8	LED DESCRIPTIONS	80
8.1	Overview LEDs Real-Time Ethernet Systems	80
8.2	Overview LEDs Fieldbus Systems.....	81
8.3	System LED.....	82
8.4	EtherCAT Master	83
8.5	EtherCAT Slave	84
8.6	EtherNet/IP Scanner (Master)	85
8.7	EtherNet/IP Adapter (Slave)	86
8.8	Open Modbus/TCP	87
8.9	POWERLINK Controlled Node/Slave	88
8.10	PROFINET IO-Controller	89
8.11	PROFINET IO-Device.....	90
8.12	sercos Master	91
8.13	sercos Slave	93
8.14	VARAN Client (Slave).....	95
8.15	PROFIBUS DP Master	96
8.16	PROFIBUS DP Slave	97
8.17	PROFIBUS MPI Device	98
8.18	CANopen Master	99
8.19	CANopen Slave	100
8.20	DeviceNet Master	101
8.21	DeviceNet Slave	102
8.22	AS Interface Master	103
8.23	CC-Link Slave.....	104
9	DEVICE CONNECTIONS AND SWITCHES	105
9.1	Ethernet Interface	105
9.1.1	Ethernet Pin Assignment at the RJ45 Socket	105
9.1.2	Ethernet Connection Data	106

9.1.3	Use of Hubs and Switches	106
9.2	PROFIBUS Interface	107
9.3	CANopen Interface	107
9.4	DeviceNet Interface	108
9.5	AS-Interface Interface	108
9.6	CC-Link Interface	109
9.7	Rotary Switch for Slot Number (Card ID).....	110
9.7.1	Set Slot Number (Card ID)	110
9.7.2	Note for Device Exchange Service (Replacement Case):	110
9.7.3	Rotary Switch Slot Number PC Cards cifX Low Profile.....	111
9.8	SYNC Connector (Pin-Assignment, Hardware/Firmware)	112
9.8.1	Pin Assignment SYNC Connector, X51 (CIFX 50 50E 70E).....	112
9.8.2	Pin Assignment SYNC Connector, J1 (CIFX 100EH)	112
9.8.3	Items on Hardware	113
9.8.4	Items on Firmware.....	113
9.9	Pin Assignment at the PCI Bus.....	114
9.9.1	Overview.....	114
9.9.2	References PCI Specifications.....	114
9.9.3	Pin Assignment for PCI Express Bus CIFX 100EH-RE\CUBE	115
10	TECHNICAL DATA	116
10.1	Technical Data PC Cards cifX	116
10.1.1	CIFX 50-RE, CIFX 50-RE\ET	116
10.1.2	CIFX 50E-RE, CIFX 50E-RE\ET	118
10.1.3	CIFX 50-DP	120
10.1.4	CIFX 50E-DP	121
10.1.5	CIFX 50-CO.....	123
10.1.6	CIFX 50E-CO	124
10.1.7	CIFX 50-DN	125
10.1.8	CIFX 50E-DN.....	127
10.1.9	CIFX 50-CC	128
10.1.10	CIFX 50E-CC.....	130
10.1.11	CIFX 50-2DP	131
10.1.12	CIFX 50-2DP\CO.....	133
10.1.13	CIFX 50-2DP\DN	134
10.1.14	CIFX 50-2CO	136
10.1.15	CIFX 50-2CO\DN.....	137
10.1.16	CIFX 50-2DN	138
10.1.17	CIFX 50-2ASM	140
10.1.18	CIFX 50E-2ASM	141
10.1.19	CIFX 70E-RE, CIFX 70E-RE\MR	143
10.1.20	CIFX 100EH-RE\CUBE	145
10.1.21	CIFX 70E-DP, CIFX 70E-DP\MR	147
10.1.22	CIFX 70E-CO, CIFX 70E-COMR	148
10.1.23	CIFX 70E-DN, CIFX 70E-DN\MR.....	150
10.2	PCI IDs PC Cards cifX on the PCI Bus.....	152

10.3	Supported PCI-Bus Commands	152
10.4	Technical Data of the Communication Protocols	153
10.4.1	EtherCAT Master	153
10.4.2	EtherCAT Slave	154
10.4.3	EtherNet/IP Scanner (Master)	155
10.4.4	EtherNet/IP Adapter (Slave)	156
10.4.5	Open Modbus/TCP	157
10.4.6	POWERLINK Controlled Node/Slave	157
10.4.7	PROFINET IO-Controller	158
10.4.8	PROFINET IO-Device (V3.4)	159
10.4.9	PROFINET IO Device (V3.5)	160
10.4.10	sercos Master	161
10.4.11	sercos Slave	162
10.4.12	VARAN Client (Slave)	163
10.4.13	PROFIBUS DP Master	164
10.4.14	PROFIBUS DP Slave	165
10.4.15	PROFIBUS MPI	166
10.4.16	CANopen Master	167
10.4.17	CANopen Slave	168
10.4.18	DeviceNet Master	169
10.4.19	DeviceNet Slave	170
10.4.20	AS-Interface Master	171
10.4.21	CC Link Slave	172
11	ANNEX	173
11.1	Device Label with Matrix Code	173
11.2	Tolerances of the shown Card Dimensions	173
11.3	Dimensions PC Cards cifX PCI and PCI Express	174
11.3.1	CIFX 50-RE, CIFX 50-RE\ET	174
11.3.2	CIFX 50E-RE, CIFX 50E-RE\ET	175
11.3.3	Front Panel CIFX 50-RE, CIFX 50-RE\ET, CIFX 50E-RE or CIFX 50E-RE\ET	176
11.3.4	CIFX 50-DP, CIFX 50E-DP	177
11.3.5	Front Panel CIFX 50-DP or CIFX 50E-DP	179
11.3.6	CIFX 50-CO, CIFX 50E-CO	180
11.3.7	Front Panel CIFX 50-CO or CIFX 50E-CO	182
11.3.8	CIFX 50-DN, CIFX 50E-DN	183
11.3.9	Front Panel CIFX 50-DN or CIFX 50E-DN	185
11.3.10	CIFX 50-CC, CIFX 50E-CC	186
11.3.11	Front Panel CIFX 50-CC or CIFX 50E-CC	188
11.3.12	CIFX 50-2DP	189
11.3.13	CIFX 50-2DP\CO	190
11.3.14	CIFX 50-2DP\DN	191
11.3.15	CIFX 50-2CO	192
11.3.16	CIFX 50-2CO\DN	193
11.3.17	CIFX 50-2DN	194
11.3.18	Front Panel CIFX 50-2FB	195
11.3.19	CIFX 50-2ASM, CIFX 50E-2ASM	196
11.3.20	Front Panel CIFX 50-2ASM, CIFX 50E-2ASM	198

11.4	Dimensions PC Cards cifX Low Profile PCI Express.....	199
11.4.1	CIFX 70E-RE, CIFX 70E-RE\MR	199
11.4.2	Front Panel CIFX 70E-RE, CIFX 70E-RE\MR	200
11.4.3	CIFX 70E-DP, CIFX 70E-DP\MR	201
11.4.4	CIFX 70E-CO, CIFX 70E-COMR	203
11.4.5	Front Panel CIFX 70E-CO, CIFX 70E-COMR.....	204
11.4.6	CIFX 70E-DN, CIFX 70E-DN\MR.....	205
11.4.7	Front Panel CIFX 70E-DN, CIFX 70E-DN\MR	206
11.5	Notes on earlier Hardware Revisions	207
11.5.1	Failure in 10 MBit/s Half Duplex Mode and Workaround	207
11.6	Disposal of Waste Electronic Equipment.....	208
11.7	References	208
11.8	EtherCAT Summary over Vendor ID, Conformance test, Membership and Network Logo.....	209
11.8.1	Vendor ID	209
11.8.2	Conformance	209
11.8.3	Certified Product vs. Certified Network Interface	209
11.8.4	Membership and Network Logo	209
11.9	List of Figures	210
11.10	List of Tables	211
11.11	Glossary.....	214
11.12	Contacts.....	223

1 Introduction

1.1 About the User Manual

This user manual provides descriptions of the **installation, operation and hardware** of the PC Cards cifX *PCI, PCI Express* and *Low Profile PCI Express* under Windows® XP, Windows® Vista, Windows® 7 and Windows® 8, as listed subsequently.

PC Cards cifX:

- PCI (CIFX 50),
- PCI Express (CIFX 50E),
- Low Profile PCI Express (CIFX 70E, CIFX 100EH-RE\CUBE*)

**only Real-Time Ethernet*

for the Real-Time Ethernet systems:

- EtherCAT
- EtherNet/IP
- Open-Modbus/TCP
- POWERLINK
- PROFINET IO
- sercos
- VARAN

for the fieldbus systems:

- PROFIBUS DP
- PROFIBUS MPI
- CANopen
- DeviceNet
- AS-Interface
- CC-Link



For information about the **Installation of the Software** refer to the User Manual „Software Installation for PC Cards cifX“ [DOC120207UMXXEN].

For information about the **Wiring of the Protocol Interface** refer to the „Wiring Instructions“ [DOC120208UMXXEN].

The **devices described in this manual** are listed in the sections

- *PC Cards PCI CIFX 50-XX* (page 27),
 - *PC Cards PCI (2 Channels) CIFX 50-2XX, CIFX 50-2XX\XX* (page 28) and
 - *PC Cards PCI Express CIFX 50E-XX, CIFX 70E-XX, CIFX 100EH-RE\CUBE* (page 28).
- The devices are described in detail in the chapters *Hardware Installation and Uninstalling* (page 72), *LED Descriptions* (page 80), *Device Connections and Switches* (page 105) and *Technical Data* (page 116).

You can download the latest edition of a manual from the website www.hilscher.com under **Support > Downloads > Manuals** or under **Products** directly with the information about your product.

1.1.1 List of Revisions

Index	Date	Chapter	Revisions
42	14-12-01	All and 3.3, 5, 8.22, 10.1.17, 10.1.18, 5.1.13, 7.1, 8.1, 8.2, 8.13, 10.1, 11.11	Updates for chapter / sections <i>PC Cards PCI (2 Channels) CIFX 50-2XX</i> , <i>CIFX 50-2XXIXX</i> , <i>Device Drawings</i> , <i>AS Interface Master</i> , <i>CIFX 50-2ASM</i> , <i>CIFX 50E-2ASM</i> : 1.) Naming for channels for 2-channel devices (instead of channel 0 and 1 -> channel X1 and X2); 2.) Naming for LEDs for AS-interface (instead of CH0 and CH1 -> COM1 and COM2). Section <i>Meaning of the Front Panel Inscriptions for 2 Channel Devices</i> added. Sections <i>Instructions for Problem Solving</i> , <i>Overview LEDs Real-Time Ethernet Systems</i> , <i>Overview LEDs Fieldbus Systems</i> and <i>sercos Slave</i> updated. Section <i>Technical Data PC Cards cifX</i> : Indications on UL certification revised. Section <i>Glossary</i> : Entries for CH0 and CH1 or X1 and X2 added.
43	15-02-10	5 10.1.9, 10.1.10, 11.1, 11.2, 11.3, 11.4	Note: 'Preliminary status' refers only to the sections 11.1 to 11.4. All other parts of this revision are in 'released status'. Chapter <i>Device Drawings</i> revised and completed. Sections <i>CIFX 50-CC</i> or <i>CIFX 50E-CC</i> : Dimensions corrected: W = 86 mm. Section <i>Device Label with Matrix Code</i> revised Sections <i>Tolerances of the shown Card Dimensions</i> , <i>Dimensions PC Cards cifX PCI</i> and <i>PCI Express</i> and <i>Dimensions PC Cards cifX Low Profile PCI Express</i> added.
44	15-06-18	8, 11.3, 11.4	Chapter <i>LED Descriptions</i> revised. Sections <i>Dimensions PC Cards cifX PCI</i> and <i>PCI Express</i> and <i>Dimensions PC Cards cifX Low Profile PCI Express</i> - slight corrections added.
45	15-07-28	11.11	Section <i>Glossary</i> : entry "Firmware" revised.
46	15-12-04	3.10	Section <i>Prerequisites for Certification</i> added.

Table 1: List of Revisions

1.1.2 Notes on Hardware, Firmware, Software and Driver Versions



Note on Software Update: The hardware revisions and the versions for the firmware, the driver or the configuration software listed in this section functionally belong together. For existing hardware installation the firmware, the driver and the configuration software must be updated according to the details listed in this section.

For the software upgrade system overview refer to section *Update for Firmware, Driver and Software* on page 44.

1.1.2.1 Hardware: PC Cards cifX

PC Card cifX	Part No.	Hardware Revision	USB from HW Rev.	„Rotary Switch Slot Number (Card ID)“ from HW Rev.	„DMA Mode“ from HW Rev.
CIFX 50-RE	1250.100	5	-	3	1
CIFX 50-REJET	1250.105	1	-	1	1
CIFX 50-DP	1250.410	5	-	5	1
CIFX 50-CO	1250.500	5	-	5	1
CIFX 50-DN	1250.510	5	-	5	1
CIFX 50-CC	1250.740	2	-	2	1
CIFX 50E-RE	1251.100	5	-	4	4
CIFX 50E-REJET	1251.105	1	-	1	1
CIFX 50E-DP	1251.410	6	-	5	5
CIFX 50E-CO	1251.500	5	-	4	4
CIFX 50E-DN	1251.510	5	-	4	4
CIFX 50E-CC	1251.740	4	-	3	3
CIFX 50-2DP	1252.410	3	-	3	1
CIFX 50-2DP\CO	1252.470	2	-	2	1
CIFX 50-2DP\DN	1252.480	1	-	1	1
CIFX 50-2CO	1252.500	2	-	2	1
CIFX 50-2CO\DN	1252.570	1	-	1	1
CIFX 50-2DN	1252.510	2	-	2	1
CIFX 50-2ASM	1252.630	2	-	2	1
CIFX 50E-2ASM	1253.630	5	-	2	4
CIFX 70E-RE	1.259.100	1	-	1	1
CIFX 70E-REVMR	1.259.103	1	-	1	1
CIFX 100EH-REVCUBE	9016.090	4	-	1	1
CIFX 70E-DP	1.259.410	1	-	1	1
CIFX 70E-DPVMR	1.259.413	1	-	1	1
CIFX 70E-CO	1.259.500	1	-	1	1
CIFX 70E-COMR	1.259.503	1	-	1	1
CIFX 70E-DN	1.259.510	1	-	1	1
CIFX 70E-DNMR	1.259.513	1	-	1	1

Table 2: Reference on Hardware PC Cards cifX

1.1.2.2 Driver and Software

Driver and Software		Version
SYCON.net	SYCONnet netX setup.exe	V1.360.x.x
netX Configuration Tool-Setup	netXConfigurationUtility_Setup.exe	1.0510.x.x
cifX Device Driver	cifX Device Driver Setup.exe	1.2.x.x
Toolkit		1.1.x.x
cifX TCP/IP Server for SYCON.net	cifX TCP Server.exe	V2.1.0.0
US Driver	USB Driver of Windows®	5.1.2600.x

Table 3: Reference on Driver and Software

1.1.2.3 Firmware

The downloadable cifX firmware runs on PC Cards cifX *PCI*, *PCI Express* and *Low Profile PCI Express*. The firmware automatically detects whether it is running on a PC Cards cifX *PCI*, *PCI Express* or *Low Profile PCI Express*.

PC Cards with one Channel:

Protocol	Firmware File	Firmware Version*	Minimum Version of the Firmware for USB Support
CANopen Master	CIFXCOM.NXF	2.11.x.x	from 2.5.2.0
CANopen Slave	CIFXCOS.NXF	3.6.x.x	from 2.4.4.0
CC-Link Slave	CIFXCCS.NXF	2.9.x.x	-
DeviceNet Master	CIFXDNM.NXF	2.3.x.x	from 2.2.7.0
DeviceNet Slave	CIFXDNS.NXF	2.3.x.x	from 2.2.7.0
EtherCAT Master	cifxecm.NXF	3.0.x.x	from 2.4.4.0
EtherCAT Slave	cifxECS.NXF	2.5. x.x (V2)	from 2.5.13.0
EtherCAT Slave	cifxECS.NXF	4.2.x.x (V4)	from 2.5.13.0
EtherNet/IP Adapter	cifxEIS.NXF	2.7. x.x	from 2.3.4.1
EtherNet/IP Scanner	cifxEIM.NXF	2.6. x.x	from 2.2.4.1
Open-Modbus/TCP	cifxOMB.NXF	2.5. x.x	from 2.3.2.1
POWERLINK Controlled Node	cifxPLS.NXF	2.1. x.x	from 2.1.22.0
PROFIBUS DP Master	CIFXDPM.NXF	2.6.x.x	from 2.3.22.0
PROFIBUS DP Slave	CIFXDPS.NXF	2.7.x.x	from 2.3.30.0
PROFIBUS MPI-Gerät	CIFXMPI.NXF	2.4.x.x	from 2.4.1.2
PROFINET IO-Controller	cifxPNM.NXF	2.6. x.x	from 2.4.10.0
PROFINET IO-Device	cifxPNS.NXF	3.4.x.x (V3)	from 3.4.9.0
PROFINET IO-Device	cifxPNS.NXF	3.5.x.x (V3)	from 3.4.9.0
sercos Master	cifxS3M.NXF	2.1.x.x	from 2.0.14.0
sercos Slave	cifxS3S.NXF	3.1.x.x	from 3.0.13.0
VARAN-Client	cifxvrs.NXF	1.0.x.x	from 1.0.3.0

Table 4: Reference on Firmware (for 1 Channel Systems)



Note: *Unless otherwise indicated, in this manual data to the firmware version correspond to the stack version.

PC Cards PCI and PCI Express with two Channels:

Protocol Channel X1	Stack-Version	Protocol Channel X2	Stack-Version	Firmware File	Firmware Version
AS-Interface Master	2.3.x.x	AS-Interface Master	2.3.x.x	CIFX2ASM.NXF	2.3.x.x
CANopen Master	2.11.x.x	CANopen Master	2.11.x.x	C0204040.NXF	1.0.x.x
CANopen Master	2.11.x.x	CANopen Slave	3.6.x.x	C0204050.NXF	1.0.x.x
CANopen Master	2.11.x.x	DeviceNet Master	2.3.x.x	C0204060.NXF	1.0.x.x
CANopen Slave	3.6.x.x	CANopen Slave	3.6.x.x	C0205050.NXF	1.0.x.x
CANopen Slave	3.6.x.x	DeviceNet Slave	2.3.x.x	C0205070.NXF	1.0.x.x
DeviceNet Master	2.3.x.x	DeviceNet Master	2.3.x.x	C0206060.NXF	1.0.x.x
DeviceNet Slave	2.3.x.x	DeviceNet Slave	2.3.x.x	C0207070.NXF	1.0.x.x
PROFIBUS DP Master	2.6.x.x	PROFIBUS DP Master	2.6.x.x	CIFX2DPM.NXF	1.0.x.x (new version counting)
PROFIBUS DP Master	2.6.x.x	CANopen Master	2.11.x.x	C0201040.NXF	1.0.x.x
PROFIBUS DP Master	2.6.x.x	DeviceNet Master	2.3.x.x	C0201060.NXF	1.0.x.x
PROFIBUS DP Slave	2.7.x.x	PROFIBUS DP Slave	2.7.x.x	CIFX2DPS.NXF	1.0.x.x (new version counting)
PROFIBUS DP Slave	2.7.x.x	CANopen Slave	3.6.x.x	C0202050.NXF	1.0.x.x
PROFIBUS DP Slave	2.7.x.x	DeviceNet Slave	2.3.x.x	C0202070.NXF	1.0.x.x

Table 5: Reference on Firmware (for 2 Channel Systems)

1.1.3 Conventions in this Manual

Notes, operation instructions and results of operation steps are marked as follows:

Notes



Important: <important note you must follow to avoid malfunction>



Note: <general note>



<note, where to find further information>

Operation Instructions

1. <instruction>
2. <instruction>

or

- <instruction>

Results

↻ <result>

Safety Messages

The labeling of safety messages is explained in the chapter *Safety*.

1.1.4 Used Terminology

PC Card cifX Communication Interfaces of the cifX family of Hilscher based on the netX technology.

CIFX 50-RE Example for the product name for a PC card cifX Real-Time Ethernet.

CIFX 50-XX Example ('XX' replaces 'RE', 'DP', 'CO', 'DN' or 'CC')



For further terminology to the PC cards cifX, its installation, configuration and operation refer to section *Glossary* on page 214.

1.2 Contents of the Product DVD

On the **Communication Solutions DVD** you will find these installation instructions about the software installation and the necessary configuration software, the documentation, the drivers and software for your PC Card cifX, and additional auxiliary tools.

1.2.1 Installation Guide, Documentation Overview



The installation guide **Software Installation and Documentation Overview** on the Communication Solutions DVD are in the directory *Documentation\0. Installation and Overview*. The installation guide includes:

- An overview on the **Content of the Communication Solutions DVD** (in the section *What is on the Communication Solutions DVD?*)
 - Overviews listing the available **Documentations** for PC cards cifX (in chapter *PC Cards cifX, Software and Documentation*).
-

1.2.2 What's New



All current version information for hardware and software described in this manual are provided in the folder *\Documentation\What's New - Communication Solutions DVD RL XX EN.pdf* on the Communication Solutions DVD.

1.2.3 Important Changes

1.2.3.1 DeviceNet Master - SYCON.net and Firmware

The DeviceNet Master firmware from V2.3.11.0 and the DeviceNet Master DTM from V1.360.x.x support the network scan function. If in the device a firmware version V2.3.10.0 or earlier is used then a firmware update to V2.3.11.0 or higher must be done, in order to use the **network scan** function.

1.2.3.2 PROFINET IO-Device Firmware Versions 3.4 and 3.5

The PROFINET IO Device firmware was revised and completed and is available in version 3.5 since the third quarter 2013.

Use the PROFINET IO Device firmware in version 3.5 for a new installation, when you create or develop your application program for the first time.

If you want to change in an existing system from the PROFINET IO Device firmware version 3.4 to the version 3.5, note the following guidelines:

1. Customize your application program according to the Migration Guide **PROFINET IO Device, Migration from V3.4 to V3.5**.



If you want to change to V3.5, please check in the Migration Guide **PROFINET IO Device, Migration from V3.4 to V3.5** which changes are necessary in the application program in order to use version 3.5.

2. Adjust the configuration of your PROFINET IO Controller device. Use the new GSDML file in the configuration software of the PROFINET IO Controller for this:
GSDML-V2.3-HILSCHER-CIFX RE PNS-20130301.xml
3. Update the PROFINET IO Device firmware in your device to version 3.5.

Note also:

- SYCON.net V1.360.x.x can configure the PROFINET IO Device firmware V3.4 as well as V3.5
- netX Configuration Tool V1.0510.x.x can configure the PROFINET IO Device firmware V3.4 as well as V3.5.
- The development of the PROFINET IO Device firmware V3.4 will not be continued, but this firmware version will be delivered furthermore.

On the Communication Solutions DVD, software and manuals relating to both firmware versions V3.4 and V3.5 are available:

	PROFINET IO-Device V3.4 Directory on the DVD \ File:	PROFINET IO-Device V3.5 Directory on the DVD \ File:
Firmware	<i>Firmware\CIFX\cifxpns.nxf</i>	<i>Firmware\CIFX\PNS V3.5.X\cifxpns.nxf</i>
Header	<i>Examples and API\0. Header\Firmware\PROFINET IO Device V3.4.X</i>	<i>Examples and API\0. Header\Firmware\PROFINET IO Device V3.5.X</i>
GSDML	<i>EDS\PROFINET\V3.4.X\GSDML-V2.3-HILSCHER-CIFX RE PNS-20130225.xml</i>	<i>EDS\PROFINET\V3.5.X\GSDML-V2.3-HILSCHER-CIFX RE PNS-20130301.xml</i>
Protocol API	<i>Documentation\7. Programming Manuals\EN\3. Protocol API\PROFINET IO Device V3.4\PROFINET IO Device Protocol API 13 EN.pdf</i> <i>TCP IP - Packet Interface API 13 EN.pdf</i>	<i>Documentation\7. Programming Manuals\EN\3. Protocol API\PROFINET IO Device V3.5\PROFINET IO Device V3.5 Protocol API 06 EN.pdf</i> <i>PROFINET IO Device - Migration from Version 3.4 to 3.5 MG 03 EN.pdf</i>

Table 6: PROFINET IO-Device Firmware Version 3.4 and 3.5, Header, GSDML and Protocol API Manual

1.2.3.3 EtherCAT Slave Firmware Versions 2.5 and 4.2

The EtherCAT Slave firmware was revised and completed and is available in version 4.2 since the third quarter 2013.

Use the EtherCAT Slave firmware in version 4.2 for a new installation, when you create or develop your application program for the first time.

If you want to change in an existing system from the EtherCAT Slave firmware version 2.5 to the version 4.2, note the following guidelines:

1. Customize your application program according to the Migration Guide **EtherCAT Slave, Migration from V2.5 to V4.2**.



If you want to change to V4.2, please check in the Migration Guide **EtherCAT Slave, Migration from V2.5 to V4.2** which changes are necessary in the application program in order to use version 4.2.

2. Adjust the configuration of your EtherCAT Master device. Use the new XML file in the configuration software of the EtherCAT Master for this: *Hilscher CIFX RE ECS V4.2.X.xml*.
3. Update the EtherCAT Slave firmware in your device to version 4.2.

Note also:

- SYCON.net V1.360.x.x can configure the EtherCAT Slave firmware V2.5 as well as V4.2.10.0 and higher.
- netX Configuration Tool V1.0510.x.x can configure the EtherCAT Slave firmware V2.5 as well as V4.2.
- The development of the EtherCAT Slave firmware V2.5 will not be continued, but this firmware version will be delivered furthermore.

On the Communication Solutions DVD, software and manuals relating to both firmware versions V2.5 and V4.2 are available:

	EtherCAT-Slave V2.5 Directory on the DVD \ File:	EtherCAT-Slave V4.2 Directory on the DVD \ File:
Firmware	<i>Firmware\CIFX\cifxecs.nxf</i>	<i>Firmware\CIFX\ECS V4.X\cifxecs.nxf</i>
Header	<i>Examples and API\0. Header\Firmware\EtherCAT Slave V2.5.X</i>	<i>Examples and API\0. Header\Firmware\EtherCAT Slave V4.2.X</i>
XML	<i>EDS\EtherCAT\Slave\V2.X\Hilscher CIFX RE ECS V2.2.X.xml</i>	<i>EDS\EtherCAT\Slave\V4.X\Hilscher CIFX RE ECS V4.2.X.xml</i>
Protocol API	<i>Documentation\7. Programming Manuals\EN\3. Protocol API\EtherCAT Slave V2\EtherCAT Slave Protocol API 21 EN.pdf</i>	<i>Documentation\7. Programming Manuals\EN\3. Protocol API\EtherCAT Slave V4\EtherCAT Slave V4 Protocol API 03 EN.pdf</i> <i>EtherCAT Slave - Migration from Version 2.5 to 4.2 MG 02 EN.pdf</i> <i>Object Dictionary V3 03 API EN.pdf</i>

Table 7: EtherCAT-Slave Firmware Version 2.5 and 4.2, Header, XML and Protocol API Manual

1.2.4 Device Description Files PC Cards cifX

The Communication Solutions DVD **EDS** directory includes the device description files for the PC Cards cifX. The device description file is required to configure the used Master device. The systems Open Modbus/TCP, AS-Interface, PROFIBUS MPI and VARAN do not use device description files.



PC Cards cifX	System	File Name of the Device Description File
CIFX 50-RE, CIFX 50-RE\ET, CIFX 50E-RE, CIFX 50E-RE\ET, CIFX 70E-RE, CIFX 70E-RE\MR, CIFX 100EH-RE\CUBE	EtherCAT Slave	For the EtherCAT Slave Firmware V2.5: <i>Hilscher cifX RE ECS V2.2.x.xml</i> (or with extension DDF) For the EtherCAT Slave Firmware with V4.2.1.0 the <i>Hilscher CIFX RE ECS V4.2.X.xml</i> is provided.
	 Note! If the XML file <i>Hilscher cifX RE ECS V2.2.x.xml</i> is used/re-installed, the firmware must be used/re-installed at the Version 2.5.x .	
	EtherNet/IP Adapter (Slave)	<i>HILSCHER CIFX-RE EIS V1.1.EDS</i>
	EtherNet/IP Scanner (Master)	<i>HILSCHER CIFX-RE EIM V1.0.eds</i>
	 Note! The description files for the EtherNet/IP Master device is needed, when an additional EtherNet/IP Master device shall communicate to a Hilscher EtherNet/IP Master device via EtherNet/IP.	
	POWERLINK Controlled Node/Slave	<i>00000044_CIFX RE PLS.xdd</i>
	PROFINET IO-Device	For the PROFINET IO Device Firmware V3.4: <i>GSDML-V2.3-HILSCHER-CIFX RE PNS-20130225.xml</i> For the PROFINET IO Device Firmware with V3.5.13.1 the <i>GSDML-V2.3-HILSCHER-CIFX RE PNS-20130301.xml</i> is provided.
	sercos Slave	<i>Hilscher CIFX RE S3S FixCFG FSPIO Default.xml</i> , <i>Hilscher CIFX RE S3S VarCFG FSPDrive.xml</i>
	 Note! If you use a sercos Master which is using SDDML files for configuration, and one of the defaults for vendor code, device ID, input data size or output data size was changed, then you have to export a new updated SDDML file from SYCON.net and import this SDDML file into the configuration software for the sercos Master.	
	CIFX 50-DP, CIFX 50-2DP, CIFX 50E-DP, CIFX 70E-DP, CIFX 70E-DP\MR	PROFIBUS DP Slave
CIFX 50-2DP\CO	PROFIBUS DP Slave CANopen Slave	<i>HIL_0B69.GSD</i> <i>CIFX CO COS.eds</i>
CIFX 50-2DP\DN	PROFIBUS DP Slave DeviceNet Slave	<i>HIL_0B69.GSD</i> <i>CIFX_DN_DNS.EDS</i>
CIFX 50-CO, CIFX 50-2CO, CIFX 50E-CO, CIFX 70E-CO, CIFX 70E-COMR	CANopen Slave	<i>CIFX CO COS.eds</i>
CIFX 50-2CO\DN	CANopen Slave DeviceNet Slave	<i>CIFX CO COS.eds</i> <i>CIFX_DN_DNS.EDS</i>
CIFX 50-DN, CIFX 50-2DN, CIFX 50E-DN, CIFX 70E-DN, CIFX 70E-DN\MR	DeviceNet Slave	<i>CIFX_DN_DNS.EDS</i>
CIFX 50-CC, CIFX 50E-CC	CC-Link Slave	<i>cifx-ccs_1.csp, cifx-ccs_2.csp, cifx-ccs_3.csp, cifx-ccs_4.csp</i> , (for one, two, three or four Remote Device Station), <i>cifx-ccs_io.csp</i> (for one Remote IO Device Station)

Table 8: Device Description Files for PC Cards cifX

1.3 Legal Notes

1.3.1 Copyright

© Hilscher, 2008-2015, Hilscher Gesellschaft für Systemautomation mbH

All rights reserved.

The images, photographs and texts in the accompanying material (user manual, accompanying texts, documentation, etc.) are protected by German and international copyright law as well as international trade and protection provisions. You are not authorized to duplicate these in whole or in part using technical or mechanical methods (printing, photocopying or other methods), to manipulate or transfer using electronic systems without prior written consent. You are not permitted to make changes to copyright notices, markings, trademarks or ownership declarations. The included diagrams do not take the patent situation into account. The company names and product descriptions included in this document may be trademarks or brands of the respective owners and may be trademarked or patented. Any form of further use requires the explicit consent of the respective rights owner.

1.3.2 Important Notes

The user manual, accompanying texts and the documentation were created for the use of the products by qualified experts, however, errors cannot be ruled out. For this reason, no guarantee can be made and neither juristic responsibility for erroneous information nor any liability can be assumed. Descriptions, accompanying texts and documentation included in the user manual do not present a guarantee nor any information about proper use as stipulated in the contract or a warranted feature. It cannot be ruled out that the user manual, the accompanying texts and the documentation do not correspond exactly to the described features, standards or other data of the delivered product. No warranty or guarantee regarding the correctness or accuracy of the information is assumed.

We reserve the right to change our products and their specification as well as related user manuals, accompanying texts and documentation at all times and without advance notice, without obligation to report the change. Changes will be included in future manuals and do not constitute any obligations. There is no entitlement to revisions of delivered documents. The manual delivered with the product applies.

Hilscher Gesellschaft für Systemautomation mbH is not liable under any circumstances for direct, indirect, incidental or follow-on damage or loss of earnings resulting from the use of the information contained in this publication.

1.3.3 Exclusion of Liability

The software was produced and tested with utmost care by Hilscher Gesellschaft für Systemautomation mbH and is made available as is. No warranty can be assumed for the performance and flawlessness of the software for all usage conditions and cases and for the results produced when utilized by the user. Liability for any damages that may result from the use of the hardware or software or related documents, is limited to cases of intent or grossly negligent violation of significant contractual obligations. Indemnity claims for the violation of significant contractual obligations are limited to damages that are foreseeable and typical for this type of contract.

It is strictly prohibited to use the software in the following areas:

- for military purposes or in weapon systems;
- for the design, construction, maintenance or operation of nuclear facilities;
- in air traffic control systems, air traffic or air traffic communication systems;
- in life support systems;
- in systems in which failures in the software could lead to personal injury or injuries leading to death.

We inform you that the software was not developed for use in dangerous environments requiring fail-proof control mechanisms. Use of the software in such an environment occurs at your own risk. No liability is assumed for damages or losses due to unauthorized use.

1.3.4 Warranty

Although the hardware and software was developed with utmost care and tested intensively, Hilscher Gesellschaft für Systemautomation mbH does not guarantee its suitability for any purpose not confirmed in writing. It cannot be guaranteed that the hardware and software will meet your requirements, that the use of the software operates without interruption and that the software is free of errors. No guarantee is made regarding infringements, violations of patents, rights of ownership or the freedom from interference by third parties. No additional guarantees or assurances are made regarding marketability, freedom of defect of title, integration or usability for certain purposes unless they are required in accordance with the law and cannot be limited. Warranty claims are limited to the right to claim rectification.

1.3.5 Export Regulations

The delivered product (including the technical data) is subject to export or import laws as well as the associated regulations of different countries, in particular those of Germany and the USA. The software may not be exported to countries where this is prohibited by the United States Export Administration Act and its additional provisions. You are obligated to comply with the regulations at your personal responsibility. We wish to inform you that you may require permission from state authorities to export, re-export or import the product.

1.3.6 Registered Trademarks

Windows[®] XP, Windows[®] Vista, Windows[®] 7 and Windows[®] 8 are registered trademarks of Microsoft Corporation.

Linux is a registered trademark of Linus Torvalds.

QNX is a registered trademark of QNX Software Systems, Ltd.

VxWorks is a registered trademark of Wind River Systems, Inc.

IntervalZero RTX[™] is a trademark of IntervalZero.

Adobe-Acrobat[®] is a registered trademark of the Adobe Systems Incorporated.

CANopen[®] is a registered trademark of CAN in AUTOMATION - International Users and Manufacturers Group e.V (CiA), Nürnberg.

CC-Link is a registered trademark of Mitsubishi Electric Corporation, Tokyo, Japan.

DeviceNet[™] and EtherNet/IP[™] are trademarks of ODVA (Open DeviceNet Vendor Association, Inc).

EtherCAT[®] is a registered trademark and a patented technology of Beckhoff Automation GmbH, Verl, Germany, formerly Elektro Beckhoff GmbH.

Modbus is a registered trademark of Schneider Electric.

POWERLINK is a registered trademark of B&R, Bernecker + Rainer Industrie-Elektronik Ges.m.b.H, Eggelsberg, Austria

PROFIBUS[®] and PROFINET[®] are registered trademarks of PROFIBUS & PROFINET International (PI), Karlsruhe.

sercos and sercos interface are registered trademarks of sercos international e. V., Suessen, Germany.

PCI[™], PCI EXPRESS[®] and PCIe[®] are trademarks or registered trademarks of the Peripheral Component Interconnect Special Interest Group (PCI-SIG).

All other mentioned trademarks are property of their respective legal owners.

1.3.7 EtherCAT Disclaimer

EtherCAT® is registered trademark and patented technology, licensed by Beckhoff Automation GmbH, Germany.



To get details and restrictions regarding using the EtherCAT technology refer to the following documents:

- “EtherCAT Marking rules”
- “EtherCAT Conformance Test Policy”
- “EtherCAT Vendor ID Policy”

These documents are available at the ETG homepage www.ethercat.org or directly over info@ethercat.org.

A summary over Vendor ID, Conformance test, Membership and Network Logo can be found within the appendix section of this document under section *EtherCAT Summary over Vendor ID, Conformance test, Membership and Network Logo* on page 209.

1.3.8 Obligation to read and understand the Manual



Important!

- To avoid personal injury and to avoid property damage to your system or to your PC card, you must read and understand all instructions in the manual and all accompanying texts to your PC card, before installing and operating your PC card.
- First read the **Safety Instructions** in the safety chapter.
- Obey to all **Safety Messages** in the manual.
- Keep the product DVD providing the product manuals.

1.4 Licenses

If a PC Card cifX is used as a Slave, neither for the firmware nor for the configuration software SYCON.net a license is required.

Licenses will be required if the PC Card cifX is used with

- a firmware with master functionality*.

* The master license includes the PC Card cifX operating as master and the license for the configuration software SYCON.net for the respective cifX.

1.4.1 License Note about VARAN Client

In order to use the PC Card cifX with VARAN, you need a license which you can acquire at the VNO (VARAN Bus-Nutzerorganisation, Bürmooser Straße 10, A-5112 Lamprechtshausen, info@varan-bus.net) after getting a member of VON.

The license as well as the Vendor ID and the Device ID can be adjusted with the SYCON.net configuration software or with the netX Configuration Tool.

2 Safety

2.1 General Note

The documentation in the form of a user manual, an operating instruction manual or other manual types, as well as the accompanying texts have been created for the use of the products by educated personnel. When using the products, all Safety Messages, Safety Messages, Property Damage Messages and all valid legal regulations have to be obeyed. Technical knowledge is presumed. The user has to assure that all legal regulations are obeyed.

2.2 Intended Use

The PC Cards cifX described in this user manual are PC cards for the Real-Time Ethernet or fieldbus communication. Depending from the loaded firmware, the Real-Time Ethernet or fieldbus systems listed in the following table can be realized using the respective PC Card cifX.

PC Cards cifX	Real-Time Ethernet System	PC Cards cifX	Fieldbus System
CIFX 50-RE, CIFX 50-RE\ET, CIFX 50E-RE, CIFX 50E-RE\ET, CIFX 70E-RE, CIFX 70E-RE\MR, CIFX 100EH-RE\CUBE	EtherCAT Master, EtherCAT Slave	CIFX 50-DP CIFX 50E-DP, CIFX 70E-DP, CIFX 70E-DP\MR	PROFIBUS DP Master, PROFIBUS DP Slave, PROFIBUS MPI Device
	EtherNet/IP Scanner (Master), EtherNet/IP Scanner (Slave)	CIFX 50-2DP	PROFIBUS DP Master, PROFIBUS DP Slave
	Open-Modbus/TCP	CIFX 50-2DP\CO	PROFIBUS DP Master, PROFIBUS DP Slave, CANopen Master, CANopen Slave
	POWERLINK-Controlled-Node/Slave	CIFX-50-2DP\DN	PROFIBUS DP Master, PROFIBUS DP Slave, DeviceNet Master, DeviceNet Slave
	PROFINET IO-Controller (Master), PROFINET IO-Device (Slave)	CIFX 50-CO CIFX 50-2CO CIFX 50E-CO, CIFX 70E-CO, CIFX 70E-CO\MR	CANopen Master, CANopen Slave
	sercos Master, sercos Slave	CIFX 50-2CO\DN	CANopen Master, CANopen Slave DeviceNet Master, DeviceNet Slave
	VARAN-Client (Slave)	CIFX 50-DN CIFX 50-2DN CIFX 50E-DN, CIFX 70E-DN, CIFX 70E-DN\MR	DeviceNet Master, DeviceNet Slave
		CIFX 50-2ASM, CIFX 50E-2ASM	AS-Interface Master
		CIFX 50-CC CIFX 50E-CC	CC-Link Slave

Table 9: PC Cards cifX and the Real-Time Ethernet or Fieldbus Systems realized thereby

2.3 Personnel Qualification

The PC Card cifX must only be installed, configured and removed by qualified personnel. Job-specific technical skills for people professionally working with electricity must be present concerning the following topics:

- Safety and health at work
- Mounting and connecting of electrical equipment
- Measurement and Analysis of electrical functions and systems
- Evaluation of the safety of electrical systems and equipment
- Installing and Configuring IT systems

2.4 Safety Instructions to avoid Personal Injury

To ensure your own personal safety and to avoid personal injury, you necessarily must read, understand and follow the following safety instructions and safety messages in this manual about danger causing personal injury, before you install and operate your PC card cifX.

2.4.1 Electrical Shock Hazard

The danger of a lethal electrical shock caused by parts with more than 50V may occur if you open the PC cabinet to install the PC Card cifX.

- HAZARDOUS VOLTAGE is present inside of the PC or of the connecting device, into which the PC Card cifX is integrated. Strictly obey to all safety rules provided by the device's manufacturer in the documentation!
- First disconnect the power plug of the PC or of the connecting device, before you open the cabinet.
- Make sure, that the power supply is off at the PC or at the connecting device.
- Open the PC cabinet and install or remove the PC Card cifX only after disconnecting power.

An electrical shock is the result of a current flowing through the human body. The resulting effect depends on the intensity and duration of the current and on its path through the body. Currents in the range of approximately ½ mA can cause effects in persons with good health, and indirectly cause injuries resulting from startle responses. Higher currents can cause more direct effects, such as burns, muscle spasms, or ventricular fibrillation.

In dry conditions permanent voltages up to approximately 42.4 V peak or 60 V are not considered as dangerous if the contact area is equivalent to the size of a human hand.

Reference Safety [S2]

2.5 Safety Instructions to avoid Property Damage

To avoid property damage respectively device destruction to the PC card cifX and to your system, you necessarily must read, understand and follow the following safety instructions and safety messages in this manual about danger causing property damage, before you install and operate your PC card.

2.5.1 Device Destruction by exceeding allowed Supply Voltage

To avoid device destruction due to high supply voltage to your PC Card cifX, you must observe the following instructions. These instructions apply to all PC Cards cifX described in this manual.

The PC Card cifX may only be operated with the specified supply voltage. Make sure that the limits of the allowed range for the supply voltage are not exceeded. A supply voltage above the upper limit can cause severe damage to the PC Card cifX! A supply voltage below the lower limit can cause malfunction in the PC Card cifX. The allowed range for the supply voltage is defined by the tolerances specified in this manual.

For the PC cards listed hereafter adhere specifically: The PC Card cifX

- CIFX 50-RE, CIFX 50-RE\ET
- CIFX 50-DP, CIFX 50-2DP, CIFX 50-2DP\CO, CIFX 50-2DP\DN, CIFX 50-CO, CIFX 50-2CO, CIFX 50-2CO\DN, CIFX 50-DN, CIFX 50-2DN, CIFX 50-2ASM, CIFX 50-CC
- CIFX 50E-RE, CIFX 50E-RE\ET
- CIFX 50E-DP, CIFX 50E-CO, CIFX 50E-DN, CIFX 50E-2ASM, CIFX 50E-CC
- CIFX 70E-RE, CIFX 70E-RE\MR, CIFX 100EH-RE\CUBE
- CIFX 70E-DP, CIFX 70E-DP\MR
- CIFX 70E-CO, CIFX 70E-CO\MR
- CIFX 70E-DN, CIFX 70E-DN\MR

may not be powered by a 5V supply voltage! The PC Card cifX may only be powered by a 3.3 V dc $\pm 5\%$ supply voltage.



The data on the mandatory supply voltage for the PC Cards cifX described in this manual you find in section *Power Supply and Host Interface* on page 34. There the required and permitted supply voltage is provided by device type inclusively the permitted tolerance range.

2.5.2 Device Destruction by exceeding allowed Signaling Voltage

To avoid device destruction due to high signal voltage to your PC Card cifX, you must observe the following instructions. These instructions apply to all PC Cards cifX described in this manual.

- All I/O signal pins at the PC Card cifX tolerate only the specified signaling voltage!
- Operating of your PC Card cifX with a signaling voltage other than the specified signaling voltage may lead to severe damage to the PC Card cifX!



The data on the mandatory signaling voltage for the PC Cards cifX described in this manual you find in the section *Power Supply and Host Interface* on page 34. There the required and permitted signaling voltage is provided by device type.

2.5.3 Electrostatically sensitive Devices

This equipment is sensitive to electrostatic discharge, which cause internal damage and affect normal operation. Therefore adhere to the necessary safety precautions for components that are vulnerable with electrostatic discharge if you install or replace your device. Follow the guidelines listed hereafter when you handle this equipment:

- Touch a grounded object to discharge potential static.
- Wear an approved grounding wriststrap.
- Do not touch connectors or pins on the PC Card cifX.
- Do not touch circuit components inside the equipment.
- If available, use a static-safe workstation.
- When not in use, store the equipment in appropriate static-safe packaging.

Reference Safety [S3]

2.6 Labeling of Safety Messages

- The **Section Safety Messages** at the beginning of a chapter are pinpointed particularly and highlighted by a signal word according to the degree of endangerment. The kind of danger is specified exactly by the safety message text and *optionally* by a specific safety sign.
- The **Integrated Safety Messages** within an instruction description are highlighted with a signal word according to the degree of endangerment. The kind of danger is specified exactly by the safety message text.







Signal Word	Meaning (international)	Meaning (USA)
	Indicates a direct hazard with high risk, which will have as consequence death or grievous bodily harm if it isn't avoided.	Indicates a Hazardous Situation Which if not Avoided, will Result in Death or Serious Injury.
	Indicates a possible hazard with medium risk, which will have as consequence death or (grievous) bodily harm if it isn't avoided.	Indicates a Hazardous Situation Which if not Avoided, could Result in Death or Serious Injury.
	Indicates a minor hazard with medium risk, which could have as consequence simple battery if it isn't avoided.	Indicates a Hazardous Situation Which if not Avoided, may Result in Minor or Moderate Injury.
Safety Sign	USA	Sort of Warning or Principle
		Warning of Lethal Electrical Shock
		Principle: Disconnect the Power Plug

Table 10: Signal Words and Safety Signs in Safety Messages on Personal Injury



Signal Word	Meaning (international and USA)
	Indicates a Property Damage Message.
Safety Sign	Sort of Warning or Principle
	Warning on Damages by Electrostatic Discharge
-	Example: Warning on Device Destruction due by too high supply voltage

Table 11: Signal Words and Safety Signs in Safety Messages on Property Damage

In this document all Safety Instructions and Safety Messages are designed according both to the international used safety conventions as well as to the ANSI Z535.6 standard, refer to reference safety [S1].

2.7 References Safety

- [S1] ANSI Z535.6-2006 American National Standard for Product Safety Information in Product Manuals, Instructions, and Other Collateral Materials
- [S2] IEC 60950-1, Information technology equipment - Safety - Part 1: General requirements, (IEC 60950-1:2005, modified); German Edition EN 60950-1:2006
- [S3] EN 61340-5-1 and EN 61340-5-2 as well as IEC 61340-5-1 and IEC 61340-5-2

3 Descriptions and Requirements

3.1 Description

The PC Cards cifX are communication interfaces of the cifX product family of Hilscher on the basis of the communication controller netX 100 for the Real-Time Ethernet or fieldbus communication. Depending of the loaded firmware, the protocol specific PC Card cifX proceeds the communication of the corresponding Real-Time Ethernet or fieldbus system.

The used Real-Time Ethernet systems are: The used fieldbus systems are:

- | | |
|--|--|
| <ul style="list-style-type: none"> ▪ EtherCAT Master ▪ EtherCAT Slave ▪ EtherNet/IP Scanner (Master) ▪ EtherNet/IP Adapter (Slave) ▪ Open-Modbus/TCP ▪ POWERLINK-Controlled-Node/Slave ▪ PROFINET IO-Controller (Master) ▪ PROFINET IO-Device (Slave) ▪ sercos Master ▪ sercos Slave ▪ VARAN Client (Slave) | <ul style="list-style-type: none"> ▪ PROFIBUS DP Master ▪ PROFIBUS DP Slave ▪ PROFIBUS MPI Device ▪ CANopen Master ▪ CANopen Slave ▪ DeviceNet Master ▪ DeviceNet Slave ▪ AS-Interface Master ▪ CC-Link Slave |
|--|--|

The PC Card cifX handles the complete data exchange between the connected Ethernet or fieldbus devices and the PC. The data exchange is proceeded via dual-port memory.

3.2 PC Cards PCI CIFX 50-XX

PC Card cifX	Description
PC Cards PCI with integrated Ethernet or fieldbus interface	
Real-Time Ethernet	
CIFX 50-RE or CIFX 50-RE\ET	Real-Time Ethernet Master or Slave Note: The PC card CIFX 50-RE\ET can be used in an enlarged temperature rage from -20 °C to +70 °C.
PROFIBUS	
CIFX 50-DP	PROFIBUS DP Master or Slave and PROFIBUS MPI Device
CANopen	
CIFX 50-CO	CANopen Master or Slave
DeviceNet	
CIFX 50-DN	DeviceNet Master or Slave
CC-Link	
CIFX 50-CC	CC-Link Slave

Table 12: PC Cards PCI CIFX 50-XX

3.3 PC Cards PCI (2 Channels) CIFX 50-2XX, CIFX 50-2XX\XX

PC Card cifX	Description
PC Cards PCI with two integrated fieldbus interfaces (2 Channels)	
PROFIBUS	
CIFX 50-2DP	2 x PROFIBUS DP Master or Slave
CIFX 50-2DP\CO	Channel X0: PROFIBUS DP Master or Slave, channel X1: CANopen Master or Slave
CIFX 50-2DP\DN	Channel X0: PROFIBUS DP Master or Slave, channel X1: DeviceNet Master or Slave
CANopen	
CIFX 50-2CO	2 x CANopen Master or Slave
CIFX 50-2CO\DN	Channel X0: CANopen Master or Slave, channel X1: DeviceNet Master or Slave
DeviceNet	
CIFX 50-2DN	2 x DeviceNet Master or Slave
AS-Interface	
CIFX 50-2ASM	2 x AS-Interface Master
CIFX 50E-2ASM	2 x AS-Interface Master

Table 13: PC Cards PCI (2 Channels) CIFX 50-2XX, CIFX 50-2XX\XX

3.4 PC Cards PCI Express CIFX 50E-XX, CIFX 70E-XX, CIFX 100EH-RE\CUBE

PC Card cifX	Description
PC Cards PCI Express with integrated Ethernet or fieldbus interface	
Real-Time Ethernet	
CIFX 50E-RE or CIFX 50E-RE\ET	Real-Time Ethernet Master or Slave Note: The PC card CIFX 50E-RE\ET can be used in an enlarged temperature range from -20°C to +70 °C.
CIFX 70E-RE, CIFX 70E-RE\MR	Low Profile PCI Express Real-Time-Ethernet Master or Slave (Low Profile PCIe with RTE)
CIFX 100EH-RE\CUBE	Real-Time Ethernet Master or Slave, (low-profile card) exclusively for the installing in KEBA KeControl industry PCs series CP 3XX (Cube).
PROFIBUS	
CIFX 50E-DP	PROFIBUS DP Master or Slave and PROFIBUS MPI Device
CIFX 70E-DP, CIFX 70E-DP\MR	Low Profile PCI Express PROFIBUS DP Master or Slave and PROFIBUS MPI Device (Low Profile PCIe with PROFIBUS)
CANopen	
CIFX 50E-CO	CANopen Master or Slave
CIFX 70E-CO, CIFX 70E-CO\MR	Low Profile PCI Express CANopen Master or Slave (Low Profile PCIe with CANopen)
DeviceNet	
CIFX 50E-DN	DeviceNet Master or Slave
CIFX 70E-DN, CIFX 70E-DN\MR	Low Profile PCI Express DeviceNet Master or Slave (Low Profile PCIe with DeviceNet)
CC-Link	
CIFX 50E-CC	CC-Link Slave

Table 14: PC Cards PCI Express CIFX 50E-XX, CIFX 70E-XX



Note: The PC cards CIFX 70E-RE\MR, CIFX 70E-DP\MR, CIFX 70E-CO\MR and CIFX 70E-DN\MR additionally are equipped with an MRAM (128Kbyte = 64K Words). For further information refer to section *PC Cards cifX with additional MRAM* on page 32.

3.5 The Function „Slot Number (Card ID)“

Device revisions equipped with a **Rotary Switch Slot Number (Card ID)** are listed separately in section *Hardware: PC Cards cifX* on page 10 in *Table 2*.

The **Slot Number (Card ID)** must be set at the PC card cifX using the **Rotary Switch Slot Number (Card ID)**. The **Slot Number (Card ID)** will serve to distinguish PC cards cifX from each other clearly, especially if several PC cards cifX are installed into the very same PC. The application program requests the **Slot Number (Card ID)** from the PC card cifX via the **cifX Device Driver**.



For further information refer to section *Rotary Switch for Slot Number (Card ID)* on page 110.

Requirements

For the application program is able to identify a PC card cifX via its **Slot Number (Card ID)** explicitly and to distinguish it from other PC cards cifX in the PC, for device revisions equipped with a **Rotary Switch for Slot Number (Card ID)** the required versions of the firmware, the driver, the bootloader and the SYCON.net setup must be used:

PC Cards with one Channel:

PC Card cifX	From Hardware Revision	Firmware File	Protocol	From Firmware Version
CIFX 50-RE, CIFX 50-RE\ET, CIFX 50E-RE, CIFX 50E-RE\ET, CIFX 70E-RE, CIFX 70E-RE\MR, CIFX 100EH-RE\CUBE	3	CIFXECM.NXF	EtherCAT Master	2.4.3.x
	1	CIFXEC.S.NXF	EtherCAT Slave	2.5.5.x
	4	CIFXEIM.NXF	EtherNet/IP Scanner	2.2.1.x
	1	CIFXEIS.NXF	EtherNet/IP Adapter	2.3.29.x
	1	CIFXOMB.NXF	Open-Modbus/TCP	2.3.3.0
	1	CIFXP.LS.NXF	POWERLINK Controlled Node	2.1.19.x
	1	CIFXP.NM.NXF	PROFINET IO Controller	2.3.x.x
	1	CIFXP.NS.NXF	PROFINET IO Device	3.3.6.x (V3)
	1	CIFXS3M.NXF	sercos Master	2.0.9.0
	1	CIFXS3S.NXF	sercos Slave	3.0.8.0
	1	CIFXVRS.NXF	VARAN Client	1.0.x.x
CIFX 50-DP, CIFX 50E-DP, CIFX 70E-DP, CIFX 70E-DP\MR	5	CIFXDPM.NXF	PROFIBUS DP Master	2.3.x.x
	5	CIFXDPS.NXF	PROFIBUS DP Slave	2.3.x.x
	1	CIFXMPI.NXF	PROFIBUS MPI Device	2.2.5.0
CIFX 50-CO, CIFX 50E-CO, CIFX 70E-CO, CIFX 70E-CO\MR	5	CIFXCOM.NXF	CANopen Master	2.3.x.x
	4	CIFXCOS.NXF	CANopen Slave	2.3.x.x
	1			
CIFX 50-DN, CIFX 50E-DN, CIFX 70E-DN, CIFX 70E-DN\MR	5	CIFXDNM.NXF	DeviceNet Master	2.2.x.x
	4	CIFXDNS.NXF	DeviceNet Slave	2.2.x.x
	1			
CIFX 50-CC, CIFX 50E-CC	2	CIFXCPS.NXF	CC-Link Slave	2.4.x.x
	2			

Table 15: Firmware Versions for the Function Slot Number (Card I), (for 1 Channel Systems)

PC Cards PCI and PCI Express with two Channels:

PC Card cifX	From Hardware Revision	Firmware File	Protocol	From Firmware Version
CIFX 50-2DP	1	CIFX2DPM.NXF	PROFIBUS DP Master, 2 Kanäle	1.0.x.x
		CIFX2DPS.NXF	PROFIBUS DP Slave, 2 Kanäle	1.0.x.x
CIFX 50-2DP\CO	1	C0201040.NXF	PROFIBUS DP Master, 1 Channel + CANopen Master, 1 Channel	1.0.x.x
		C0202050.NXF	PROFIBUS DP Slave, 1 Channel + CANopen Slave, 1 Channel	1.0.x.x
CIFX 50-2DP\DN	1	C0201060.NXF	PROFIBUS DP Master, 1 Channel + DeviceNet Master, 1 Channel	1.0.x.x
		C0202070.NXF	PROFIBUS DP Slave, 1 Channel + DeviceNetSlave, 1 Channel	1.0.x.x
CIFX 50-2CO	1	C0204040.NXF	CANopen Master, 2 Channels	1.0.x.x
		C0204050.NXF	CANopen Master, 1 Channel + CANopen Slave, 1 Channel	1.0.x.x
		C0205050.NXF	CANopen Slave, 2 Channels	1.0.x.x
CIFX 50-2CO\DN	1	C0204060.NXF	CANopen Master, 1 Channel + DeviceNet Master, 1 Channel	1.0.x.x
		C0205070.NXF	CANopen Slave, 1 Channel + DeviceNet Slave, 1 Channel	1.0.x.x
CIFX 50-2DN	1	C0206060.NXF	DeviceNet Master, 2 Channels	1.0.x.x
		C0207070.NXF	DeviceNet Slave, 2 Channels	1.0.x.x
CIFX 50-2ASM, CIFX 50E-2ASM	2 2	CIFX2ASM.NXF	AS-Interface Master, 2 Channels	2.1.x.x

Table 16: Firmware Versions for the Function Slot Number (Card ID) (for 2 Channel Systems)

Driver and Software	Version or higher
cifX Device Driver	cifX Device Driver Setup.exe 0.95x
SYCON.net	SYCONnet netX setup.exe V1.201.x.x

Table 17: Versions Driver, Bootloader and SYCON.net for Function Slot Number (Card ID)

- The **cifX Device Driver** versions **0.950** and higher identify PC cards cifX alternatively via its **Slot Number (Card ID)** if this is supported by the hardware.
- The **cifX Device Driver** up to version **0.94x** identifies PC cards cifX via its device and serial number. For the device exchange service respectively a manual intervention is required.

3.6 The Function „DMA Mode“

Device revisions which provide **DMA Mode** are listed separately in section *Hardware: PC Cards cifX* on page 10 in *Table 2*.



Note: The functions **Slot Number (Card ID)** and **DMA Mode** are in technical view independently from each other.

The **DMA Mode** is activated via the device driver **cifX Device Driver**.



For further information refer to the user manual **Software Installation for the PC Cards cifX** in section *Activating DMA Mode in the cifX Device Driver Setup*.

Requirements

For device revisions providing the **DMA Mode** the required versions of the firmware, the driver and the SYCON.net setup must be used:

PC Cards with one Channel:

PC Card cifX	From Hardware Revision	Firmware File	Protocol	From Firmware Version	
CIFX 50-RE, CIFX 50-RE\ET, CIFX 50E-RE, CIFX 50E-RE\ET, CIFX 70E-RE, CIFX 70E-RE\MR, CIFX 100EH-RE\CUBE	1	CIFXECM.NXF	EtherCAT Master	2.4.6.0	
	1	CIFXECS.NXF	EtherCAT Slave	2.5.5.0	
	4	CIFXEIM.NXF	EtherNet/IP Scanner	2.2.x.x	
	1	CIFXEIS.NXF	EtherNet/IP Adapter	2.3.x.x	
	1	CIFXOMB.NXF	Open-Modbus/TCP	2.4.x.x	
	1	CIFXPLS.NXF	POWERLINK Controlled Node	2.1.24.0	
			CIFXPNM.NXF	PROFINET IO Controller	2.3.x.x
			CIFXPNS.NXF	PROFINET IO Device	3.4.x.x (V3)
			CIFXS3M.NXF	sercos Master	2.0.15.0
			CIFXS3S.NXF	sercos Slave	3.0.15.0
			CIFXVRS.NXF	VARAN Client	1.0.x.x
CIFX 50-DP, CIFX 50E-DP, CIFX 70E-DP, CIFX 70E-DP\MR	1	CIFXDPM.NXF	PROFIBUS DP Master	2.3.x.x	
	4	CIFXDPS.NXF	PROFIBUS DP Slave	2.3.x.x	
	1	CIFXMPI.NXF	PROFIBUS MPI Device	<i>not supported</i>	
CIFX 50-CO, CIFX 50E-CO, CIFX 70E-CO, CIFX 70E-COMR	1	CIFXCOM.NXF	CANopen Master	2.3.x.x	
	4	CIFXCOS.NXF	CANopen Slave	2.3.x.x	
	1				
CIFX 50-DN, CIFX 50E-DN, CIFX 70E-DN, CIFX 70E-DN\MR	1	CIFXDNM.NXF	DeviceNet Master	2.2.x.x	
	4	CIFXDNS.NXF	DeviceNet Slave	2.2.x.x	
	1				
CIFX 50-CC, CIFX 50E-CC	1	CIFXCCS.NXF	CC-Link Slave	2.4.x.x	
	3				

Table 18: Firmware Versions for the DMA Mode (for 1 Channel Systems)

PC Cards PCI and PCI Express with two Channels:

PC Card cifX	From Hardware Revision	Firmware File	Protocol	From Firmware Version
CIFX 50-2DP	1	CIFX2DPM.NXF	PROFIBUS DP Master, 2 Kanäle	1.0.x.x (new version counting)
		CIFX2DPS.NXF	PROFIBUS DP Slave, 2 Kanäle	1.0.x.x (new version counting)
CIFX 50-2DP\CO	1	C0201040.NXF	PROFIBUS DP Master, 1 Channel + CANopen Master, 1 Channel	1.0.x.x
		C0202050.NXF	PROFIBUS DP Slave, 1 Channel + CANopen Slave, 1 Channel	1.0.x.x
CIFX 50-2DP\DN	1	C0201060.NXF	PROFIBUS DP Master, 1 Channel + DeviceNet Master, 1 Channel	1.0.x.x
		C0205070.NXF	PROFIBUS DP Slave, 1 Channel + DeviceNetSlave, 1 Channel	1.0.x.x
CIFX 50-2CO	1	C0204040.NXF	CANopen Master, 2 Channels	1.0.x.x
		C0204050.NXF	CANopen Master, 1 Channel + CANopen Slave, 1 Channel	1.0.x.x
		C0205050.NXF	CANopen Slave, 2 Channels	1.0.x.x
CIFX 50-2CO\DN	1	C0204060.NXF	CANopen Master, 1 Channel + DeviceNet Master, 1 Channel	1.0.x.x
		C0205070.NXF	CANopen Slave, 1 Channel + DeviceNet Slave, 1 Channel	1.0.x.x
CIFX 50-2DN	1	C0206060.NXF	DeviceNet Master, 2 Channels	1.0.x.x
		C0207070.NXF	DeviceNet Slave, 2 Channels	1.0.x.x
CIFX 50-2ASM, CIFX 50E-2ASM	2 4	CIFX2ASM.NXF	AS-Interface Master, 2 Channels	2.1.x.x

Table 19: Firmware Versions for the DMA Mode (for 2 Channel Systems)

Driver and Software	Version or higher
cifX Device Driver	cifX Device Driver Setup.exe 0.95x
SYCON.net	SYCONnet netX setup.exe V1.201.x.x

Table 20: Versions Driver and SYCON.net for the DMA Mode

3.7 PC Cards cifX with additional MRAM

The PC cards CIFX 70E-XX\MR (CIFX 70E-RE\MR, CIFX 70E-DP\MR, CIFX 70E-CO\MR and CIFX 70E-DN\MR) are identical to the PC cards CIFX 70E-XX and work with the same firmware. However, the PC cards CIFX 70E-XX\MR have an additional memory module for storing remanent data, MRAM with 128Kbyte (= 64K words). Using the cifX Device Driver (from Version 1.1.1.0) access from the application program to this memory is possible and it can be used as a remanent memory for the host system.

3.8 System Requirements

3.8.1 Slot for the PC Cards cifX PCI, PCIe and Low Profile PCIe

PC with slot (3.3 V) for PC cards cifX *PCI, PCI Express* and *Low Profile PCI Express*:

PC Cards cifX	PCI Bus [Pins]	Slot
CIFX 50-RE CIFX 50-RE\ET CIFX 50-DP CIFX 50-2DP CIFX 50-2DP\CO CIFX 50-2DP\DN CIFX 50-CO CIFX 50-2CO CIFX 50-2CO\DN	CIFX 50-DN CIFX 50-2DN CIFX 50-2ASM CIFX 50-CC	124 PCI slot (3.3 V)
CIFX 50E-RE CIFX 50E-RE\ET CIFX 50E-DP CIFX 50E-CO CIFX 50E-DN CIFX 50E-2ASM CIFX 50E-CC	CIFX 70E-RE, CIFX 70E-RE\MR, CIFX 70E-DP, CIFX 70E-DP\MR, CIFX 70E-CO, CIFX 70E-CO\MR, CIFX 70E-DN, CIFX 70E-DN\MR	36 PCI Express x1 slot (3.3 V), x1 ¹ = One Lane [bus spec 3]
<div style="background-color: #0056b3; color: white; padding: 2px; display: inline-block;">NOTICE</div> <p>Device Destruction!</p> <p>The PC card CIFX 100EH-RE\CUBE may not be installed in standard PCs.</p> <p>The pin assignment of the PCI Express bus does not meet the standard [bus spec 3]. By consequence malfunction can occur at the PCI express bus.</p> <p>Install the PC card CIFX 100EH-RE\CUBE exclusively in KEBA KeControl industry PCs series CP 3XX (Cube).</p>		
CIFX 100EH-RE\CUBE	64	PCI Express x4 slot (3.3 V), x4 ¹ = Four Lane In the PCI Express x4 slot only lane 0 is used. For further details refer to section <i>Pin Assignment for PCI Express Bus CIFX 100EH-RE\CUBE</i> on page 115.

Table 21: Slot for the PC Cards cifX PCI, PCIe and Low Profile PCIe

¹ The terms "x1" or "x4" refer to the convention of the PCI Express specifications [bus spec 3] to the number of lanes in the slot.

3.9 Requirements for Operation of the PC Card cifX

Operating the PC cards cifX properly, the following described requirements must be fulfilled.



Protocols	EtherCAT Slave, EtherCAT Master, EtherNet/IP Adapter (Slave), EtherNet/IP Scanner (Master), Open-Modbus/TCP, POWERLINK-Controlled-Node/Slave, PROFINET IO Device (Slave), PROFINET IO Controller (Master),	sercos Slave, sercos Master, VARAN Client (Slave), PROFIBUS DP Slave, PROFIBUS DP Master, PROFIBUS MPI Device, CANopen Slave, CANopen Master,	DeviceNet Slave, DeviceNet Master, AS-Interface Master; CC-Link Slave
Software Installation	<p>1. Driver for the Host Interface Host Interfaces: PCI and PCI Express</p> <ul style="list-style-type: none"> The device driver cifX Device Driver must be installed (from V1.0.x.x). If you install the device into a PC, in general Windows® will be available as operating system. In this case the cifX Device Driver must be installed to communicate to the device and to exchange data via the dual-port memory,. <p> Important! Upgrade older versions of the cifX Device Driver necessarily on the current version indicated in section <i>Driver and Software</i> on page 11.</p> <hr/> <p>OR</p> <ul style="list-style-type: none"> If Windows® is not available as operating system, an own driver must be developed using the cifX Driver Toolkit and this driver must be installed. For the operating systems Linux, Windows® CE, VxWorks, QNX and IntervalZero RTX™ you can buy Device Driver at the company Hilscher Gesellschaft für Systemautomation mbH http://www.hilscher.com/. <p>2. The configuration software SYCON.net or alternatively the simple Slave configuration tool netX Configuration Tool must be installed or another application program by which the PC card cifX (Slave) can be parameterized.</p>		
How to use the Software	<p>On how to use the software for the configuration, the firmware download and for the diagnosis, note the following notice:</p> <p> Important! The <u>USB interface</u>, the <u>serial interface</u> as well as the <u>cifX Device Driver</u> may only be used exclusively by one software, that is</p> <ul style="list-style-type: none"> - the SYCON.net configuration software (with integrated ODMV3) or - the netX Configuration Tool or - the cifX Test Application or - the cifX Driver Setup Utility or - the application program. <p>Never use the listed software simultaneously, otherwise this will result in communication problems with the device. If the SYCON.net configuration software was used on the PC, then stop the ODMV3 service before you use one of the other software listed above. Therefore, select Service > Stop from the context menu of the ODMV3 system tray icon.</p>		
Firmware Download	<p>3. Using the configuration software SYCON.net or for the Slave alternatively the Slave configuration tool netX Configuration Tool, the user must select and download the firmware to the PC card cifX.</p>		
Parameter Setting	<p>4. The PC card cifX must be parameterized using one of the following options:</p> <ul style="list-style-type: none"> • Configuration Software SYCON.net • alternatively Slave configuration tool netX Configuration Tool (only Slave) • Application program (programming required) 		
Communication	<p>5. For the communication of a PC card cifX (Slave) a Master device for the respective communication system is required. For the communication of a PC card cifX (Master) a Slave device for the respective communication system is required.</p>		
PC Settings for PC Cards cifX PCI Express	<p> Important! If you install a PC card cifX PCI Express, you <u>always</u> must disable the Microsoft Windows "Link State Power Management". Otherwise, it cannot be excluded that your PC freezes during the PC card cifX PCI Express is in operation.</p>		
Environmental Conditions	<p>Due to a plug element from ERNI the lower limit of the operating temperature for all PC cards cifX Real-Time Ethernet is 0 °C. This applies to all hardware revisions of the PC card cifX Real-Time Ethernet.</p>		

Table 23: Requirements to operate PC Cards cifX properly

3.10 Prerequisites for Certification

3.10.1 PROFINET IO Certification for IRT and SYNC0 Signal

3.10.1.1 Providing SYNC0 Signal at SYNC Connector of the PC Card cifX



Note: A PROFINET IO certification for PROFINET IRT requires (mandatory) that your PC card cifX offers the synchronization signal (SYNC0), in order to allow e. g. connecting an oscilloscope. Therefore the SYNC connector of your PC card cifX must be accessible.

Information about where the SYNC connector is placed on your PC card cifX, you can find in the chapter *Device Drawings* on page 45.

3.10.1.2 Using the SYNC0 Signal at the Host System

Only valid for PC Card CIFX 100EH-RE\CUBE:

If you forward the SYNC0 signal of your PC card cifX 100 EH-RE\CUBE to the PCI Express bus X2, you must adhere to the following design specification:



Note: A PROFINET IO certification for PROFINET IRT requires (mandatory) that the host system offers a connector for the synchronization signal (SYNC0), in order to allow e. g. connecting an oscilloscope.

For this purpose you must use the SYNC0 signal and mass of the PCI Express bus X2 of the PC card cifX 100EH-RE\CUBE at the host system and provide it at the host system via a well accessible 2-pin connector.

The PC card CIFX 100 EH-RE\CUBE provides the SYNC0 signal SYNC0. If at the SYNC connector (J1) the jumper is set on Pin1-Pin2, the SYNC0 signal is provided at pin B24 of the PCI Express bus X2. For further details on the pin assignment of the SYNC connector and on how to set the jumpers, refer to section *Pin Assignment SYNC Connector, J1 (CIFX 100EH)* on page 112. For the pin assignment of the PCI Express bus X2, refer to section *Pin Assignment for PCI Express Bus CIFX 100EH-RE\CUBE* on page 115.

The SYNC0 signal has LVTTTL level (3.3 V). A maximum load of 6 mA must not be exceeded.





You should keep the cable length for the sync signals below 50 mm and take into account EMC aspects.

4 Getting Started

4.1 Installation and Configuration PC Card cifX

The following table describes the steps for the software and hardware installation and for the configuration of a PC card cifX (Master and Slave) Real-Time Ethernet and fieldbus as it is typical for many cases. The Slave device can be configured using the corresponding Slave DTM in the configuration software **SYCON.net**. Alternatively, you can also use the simple Slave configuration tool **netX Configuration Tool**. The Master device can be configured using the corresponding Master DTM in the configuration software **SYCON.net**.

#	Step	Description	For detailed information see manual / section	Page
1	Installing Driver and Software			
1.1	Installing cifX Device Driver	Enter the Communication Solutions DVD in the PC and follow to the instructions of the installation wizard, to install the driver.	<i>Refer to User Manual Software Installation for the PC cards cifX</i>	
1.2	Installing SYCON.net	<u>For PC Cards cifX Master or Slave:</u> Run the SYCON.net-Setup and follow to the instructions of the installation wizard.		
1.3	Installing netX Configuration Tool	<u>For PC Cards cifX Slave:</u> Start the netX Configuration Tool setup program to install the netX Configuration Tool .		
2	Preparing Hardware Installation			
2.1	Take precautions on Electrostatically sensitive Devices	<div style="background-color: #0056b3; color: white; padding: 2px; text-align: center; font-weight: bold;">NOTICE</div> <p>Electrostatically sensitive Devices Make sure, that the PC card cifX is grounded via the endplate and the PC and make sure, that you are discharged when you install/ uninstall the PC card cifX.</p>	<i>Electrostatically sensitive Devices</i>	25
2.2	Glue sticker on the front plate.	<u>For CIFX 50-RE, CIFX 50E-RE, CIFX 70E-RE, CIFX 70E-RE\MR and CIFX 100EH-RE\CUBE</u>	<i>Fix Front Plate Sticker</i>	74
2.2	Set the Slot Number (Card ID)	Value 0 or a value from 1 to 9	<i>Rotary Switch for Slot Number (Card ID)</i>	110
3	Hardware Installation	Installing cifX. Take required safety precautions.	<i>Hardware Installation and Uninstalling</i>	72
3.1	Take safety precautions	<div style="background-color: #ff9900; color: white; padding: 2px; text-align: center; font-weight: bold;">⚠ WARNING</div> <p>Lethal Electrical Shock caused by parts with more than 50V! Disconnect the power plug of the PC or of the connecting device. Make sure, that the power supply is off at the PC or at the connecting device.</p>	<i>Electrical Shock Hazard</i>	23
3.2	Open cabinet	Now open the cabinet of the PC or of the connecting device.	<i>Installing PC Card cifX PCI, PCIe, Low Profile PCIe</i>	77

#	Step	Description	For detailed information see manual / section	Page
3.3	Installing cifX	<p>Plug in and mount the PC card cifX.</p> <p><u>Notice for CIFX 100EH-RE\CUBE:</u></p> <p>NOTICE</p> <p>Device Destruction!</p> <p>Install the PC card CIFX 100EH-RE\CUBE exclusively in KEBA KeControl industry PCs series CP 3XX (Cube). Otherwise yy consequence malfunction can occur at the PCI express bus.</p>		
3.4	Close cabinet	Close the cabinet of the PC or connecting device.		
3.5	Plug the connecting cable to the Master or Slave	<p><u>Note for all PC Cards cifX Real-Time Ethernet:</u></p> <p> Note! The RJ45 socket is only for use in LAN, not for telecommunication circuits.</p> <p><u>Note for PC Cards cifX PROFINET IO Controller:</u></p> <p> Important for Hardware Wiring! Connect only ports with each other, which have different cross-over settings. Otherwise a connection between the devices can not be established. If the port settings of the PC card cifX PROFINET IO controller are not set to AUTO, then Port0 is switched uncrossed and Port1 crossed.</p> <p>Plug in the connecting cable from the PC card cifX to the PC card Master or Slave.</p>	<p><i>Ethernet Interface</i></p> <p><i>See corresponding user manual</i></p>	105
3.6	Connect the PC to the power / switch on.	Connect the PC or the connecting device to the power supply and switch it on.		
4	Hardware Settings	Hardware Settings in the Driver Setup		
4.1	Set Slot Number (Card ID)	Set in the cifX Device Driver Setup the Slot Number (Card ID) which has been set at the PC card cifX (hardware).	<i>Refer to User Manual Software Installation for the PC Cards cifX</i>	
4.2	DMA Mode in the cifX Device Driver Setup	Activate the DMA Mode in the cifX Device Driver Setup.		
5	PC Settings			
5.1	for PC Cards cifX PCI Express	<p> Important! If you install a PC card cifX PCI Express, you <u>always</u> must disable the Microsoft Windows "Link State Power Management". Otherwise, it cannot be excluded that your PC freezes during the PC card cifX PCI Express is in operation.</p>	<i>Refer to User Manual Software Installation for the PC Cards cifX</i>	
6	Notice on how to use the Software	Use only one Software.		
6.1	<u>For the configuration, the firmware download and for the diagnosis, note:</u>	<p> Important! To avoid communication problems with the device, use the <u>USB interface</u>, the <u>serial interface</u> as well as the <u>cifX Device Driver</u> exclusively with one software that is SYCON.net or netX Configuration Tool.</p>	<i>Requirements for Operation of the PC Card cifX</i>	35

#	Step	Description	For detailed information see manual / section	Page
9.3	Download Configuration	- Download the configuration to the PC card cifX (Master).	<i>Master Device</i>	
10	Slave Diagnosis by SYCON.net (Slave and Master)	Diagnosis, I/O Data Use the corresponding Slave or Master DTM in the configuration software SYCON.net .		
10.1	Diagnostic	- Rightclick on the device symbol. - Select context menu entry Diagnosis , then select Diagnosis > General or Firmware Diagnosis , - or select Diagnosis > Extended Diagnosis .	<i>See corresponding user manual</i>	
10.2	I/O Monitor	- Rightclick on device symbol. - Select context menu entry Diagnosis , then Tools > IO Monitor . - Check the input or output data.		
11	OR Slave Diagnosis by netX Configuration Tool (only Slave)	Diagnosis		
11.1	Configuration Steps cifX (Slave)	If SYCON.net was already used on the PC, stop the ODMV3 service. Therefore, select Service > Stop from the context menu of the ODMV3 system tray icon. In the netX Configuration Tool : - In the navigation area click on Diagnostic , - click in the Diagnostic pane to Start , to start the communication to the Master device and to run the diagnosis. - click on Extended , to run the extended diagnosis.	<i>See Operating Instruction Manual netX Configuration Tool for cifX, comX and netJACK</i>	

Table 24: Steps for the Software and Hardware Installation, the Configuration and for the Diagnosis of a PC Card cifX (Master and Slave)

4.2 Note on Exchange Service (Replacement Case)

For the exchange service (replacement case) of a PC card cifX (Master and Slave) obey to the following note.



Important! For the replacement card cifX with **Rotary Switch Slot Number (Card ID)** set the same **Slot Number (Card ID)** as at the previous PC card cifX (see section *Rotary Switch for Slot Number (Card ID)* on page 110).

For PC cards cifX without **Rotary Switch Slot Number (Card ID)** in terms of a device exchange service (replacement case) you must manually download the same firmware and configuration into the replacement card cifX, as into the preceding cifX.

4.3 Notes for the Configuration of the Master Device

To configure the Master, a device description file is required. Please note the following notes for the configuration of the Master Device:

System	Note
<i>EtherCAT Slave</i>	To configure the Master, an XML file (device description file) is required. The settings in the used Master must comply with the settings in the Slave to establish communication. Important parameters are: Vendor ID, Product Code, Serial Number, Revision Number, Output and Input Data Bytes.

System	Note
<i>EtherCAT Slave</i>	<p>If the XML file <i>Hilscher cifX RE ECS V2.2.x.xml</i> is use/updated, the firmware with the version 2.2.x must be use/updated.</p> <p>The loadable firmware supports for the number of cyclic input data and for cyclic output data in total up to 400 bytes. If more than 200 bytes for input data or for output data should be exchanged via EtherCAT, then a customer specific XML file is necessary. Additionally the following formular applies: $(\text{number of input bytes} + 3)/4 + (\text{number of output bytes} + 3)/4$ must be less or equal to 100.</p>
<i>EtherNet/IP Adapter</i>	To configure the Scanner/Master, an EDS file (device description file) is required. The settings in the used Scanner/Master must comply with the settings in the Adapter/Slave to establish communication. Important parameters are: Input, Output Data Bytes, Vendor ID, Product Type, Product Code, Major Rev, Minor Rev, IP Address and Netmask.
<i>POWERLINK-Controlled-Node/Slave</i>	To configure the Managing Node/Master, an XDD file (device description file) is required. The settings in the used Managing Node/Master must comply with the settings in the Controlled Node/Slave, to establish communication. Important parameters are: Vendor ID, Product Code, Serial Number, Revision Number, Node ID, Output and Input length.
<i>PROFINET IO Device</i>	<p>To configure the Controller, a GSDML file (device description file) is required. The settings in the used Controller must comply with the settings in the Device to establish communication. Important parameters are: Station Name, Vendor ID, Device ID, Input and Output Data Bytes.</p> <p>Under Name of Station, the name must be typed which was also used in the configuration file of the master of this device. If no name chosen freely is used in the configuration file, then the name from the GSDML file is used.</p>
<i>sercos Slave</i>	<p>The sercos Master uses the sercos address to communicate with the slave. Some Masters will verify Device ID, Vendor Code, Input Data Size and Output Data Size and will do further communication to the Slave only if all these values match. Therefor the Master reads these parameters from the Slave and compares them with the configuration stored in the Master.</p> <p>The parameters Device ID, Vendor Code, Input Data Size and Output Data Size are part of the SDDML device description file. If for the configuration of the sercos Master SDDML files are used and a default value of one of these parameters was changed, then a SDDML file must be created in the configuration software via Export SDDML and then used in the configuration of the sercos Master.</p>
<i>PROFIBUS DP Slave</i>	To configure the Master, a GSD file (device description file) is required. The settings in the used Master must comply with the settings in the Slave to establish communication. Important parameters are: Station Address, Ident Number, Baudrate and Config Data (the configuration data for the output and input length).
<i>CANopen Slave</i>	To configure the Master, an EDS file (device description file) is required. The settings in the used Master must comply with the settings in the Slave to establish communication. Important parameters are: Node Address and Baudrate.
<i>DeviceNet Slave</i>	To configure the Master, an EDS file (device description file) is required. The settings in the used Master must comply with the settings in the Slave to establish communication. Important parameters are: MAC ID, Baudrate, Produced Size, Consumed Size, Vendor ID, Product Type, Product Code, Major Rev, Minor Rev.
<i>CC-Link Slave</i>	To configure the Master, a CSP file (device description file) is required. The settings in the used Master must comply with the settings in the Slave to establish communication. Important parameters are: Slave Station Address, Baudrate, Station Type and Vendor Code.

Table 25: Notes for the Configuration of the Master Device



Further information to the device description files you find under section on *Device Description Files PC Cards cifX* page 17.

4.4 Device Names in SYCON.net

The following table contains the device names displayed for the single communication protocols in the configuration software SYCON.net.

The table shows the PC card cifX and which protocol can be used. Furthermore, the table shows, for which protocol which device must be selected from the device catalog to configure the PC card cifX with SYCON.net.

PC Cards cifX	Protocol	DTM Specific Group	Device Name in SYCON.net
CIFX 50-RE, CIFX 50-RE\ET, CIFX 50E-RE, CIFX 50E-RE\ET CIFX 70E-RE, CIFX 70E-RE\MR, CIFX 100EH-RE\CUBE	EtherCAT Master	Master	CIFX RE/ECM
	EtherCAT Slave	Gateway/Stand-Alone Slave	CIFX RE/ECS
	EtherNet/IP Scanner (Master)	Master	CIFX RE/EIM
	EtherNet/IP Adapter (Slave)	Gateway/Stand-Alone Slave	CIFX RE/EIS
	Open-Modbus/TCP	Gateway/Stand-Alone Slave	CIFX RE/OMB
	POWERLINK-Controlled-Node/Slave	Gateway/Stand-Alone Slave	CIFX RE/PLS
	PROFINET IO-Controller	Master	CIFX RE/PNM
	PROFINET IO-Device	Gateway/Stand-Alone Slave	CIFX RE/PNS
	sercos Master	Master	CIFX RE/S3M
	sercos Slave	Gateway/Stand-Alone Slave	CIFX RE/S3S
	VARAN Client (Slave)	Gateway/Stand-Alone Slave	CIFX RE/VRS
CIFX 50-DP, CIFX 50E-DP, CIFX 70E-DP, CIFX 70E-DP\MR	PROFIBUS DP Master	Master	CIFX DP/DPM
	PROFIBUS DP Slave	Gateway/ Stand-Alone Slave	CIFX DP/DPS
	PROFIBUS MPI Device	Gateway/ Stand-Alone Slave	CIFX DP/MPI
CIFX 50-2DP	PROFIBUS DP Master	Master	2*CIFX DP/DPM <i>for each PROFIBUS DP channel one CIFX DP/DPM</i>
	PROFIBUS DP Slave	Gateway/ Stand-Alone Slave	2*CIFX DP/DPS <i>for each PROFIBUS DP channel one CIFX DP/DPS</i>
CIFX 50-2DP\CO	PROFIBUS DP Master, CANopen Master	Master	1*CIFX DP/DPM, <i>for PROFIBUS DP channel one CIFX DP/DPM</i> 1*CIFX CO/COM, <i>for CANopen channel one CIFX CO/COM</i>
	PROFIBUS DP Slave, CANopen Slave	Gateway/ Stand-Alone Slave	1*CIFX DP/DPS, <i>for PROFIBUS DP channel one CIFX DP/DPS</i> 1*CIFX CO/COS, <i>for CANopen channel one CIFX CO/COS</i>
CIFX 50-2DP\DN	PROFIBUS DP Master, DeviceNet Master	Master	1*CIFX DP/DPM, <i>for PROFIBUS DP channel one CIFX DP/DPM</i> 1*CIFX DN/DNM, <i>for DeviceNet channel one CIFX DN/DNM</i>
	PROFIBUS DP Slave, DeviceNet Slave	Gateway/ Stand-Alone Slave	1*CIFX DP/DPS, <i>for PROFIBUS DP channel one CIFX DP/DPS</i> 1*CIFX DN/DNS,

PC Cards cifX	Protocol	DTM Specific Group	Device Name in SYCON.net
			<i>for DeviceNet channel one CIFX DN/DNS</i>
CIFX 50-CO CIFX 50E-CO, CIFX 70E-CO, CIFX 70E-COMR	CANopen Master	Master	CIFX CO/COM
	CANopen Slave	Gateway/ Stand-Alone Slave	CIFX CO/COS
CIFX 50-2CO	CANopen Master	Master	2* CIFX CO/COM <i>for each CANopen channel one CIFX CO/COM</i>
	CANopen Master, CANopen Slave	Master, Gateway/ Stand-Alone Slave	1* CIFX CO/COM, <i>for 1 CANopen channel one CIFX CO/COM</i> 1* CIFX CO/COS, <i>for 1 CANopen channel one CIFX CO/COS</i>
	CANopen Slave	Gateway/Stand-Alone Slave	2*CIFX CO/COS <i>for each CANopen channel one CIFX CO/COS</i>
CIFX 50-CO/DN	CANopen Master, DeviceNet Master	Master	1* CIFX CO/COM, <i>for CANopen channel one CIFX CO/COM</i> 1*CIFX DN/DNM, <i>for DeviceNet channel one CIFX DN/DNM</i>
	CANopen Slave, DeviceNet Slave	Gateway/Stand-Alone Slave	1* CIFX CO/COS, <i>for CANopen channel one CIFX CO/COS</i> 1* CIFX DN/DNS, <i>for DeviceNet channel one CIFX DN/DNS</i>
CIFX 50-DN CIFX 50E-DN, CIFX 70E-DN	DeviceNet Master	Master	CIFX DN/DNM
	DeviceNet Slave	Gateway/ Stand-Alone Slave	CIFX DN/DNS
CIFX 50-2DN, CIFX 70E-DNMR	DeviceNet Master	Master	2* CIFX DN/DNM <i>for each DeviceNet channel one CIFX DN/DNM</i>
	DeviceNet Slave	Gateway/Stand-Alone Slave	2* CIFX DN/DNS <i>for each DeviceNet channel one CIFX DN/DNS</i>
CIFX 50-2ASM, CIFX 50E-2ASM	AS-Interface Master	Master	CIFX AS/ASM <i>for each AS-Interface channel one CIFX AS/ASM</i>
CIFX 50-CC CIFX 50E-CC	CC-Link Slave	Gateway/ Stand-Alone Slave	CIFX CC/ CCS

Table 26: Device Names in SYCON.net by Communication Protocol

4.5 Update for Firmware, Driver and Software



Note: As a pre-requirement for the software update the project files, the configuration files and firmware files are to be saved.

At existing hardware installation the firmware, the driver and the configuration software must be updated according to the versions given in section *Notes on Hardware, Firmware, Software and Driver Versions* on page 10. The following graphic gives an overview:

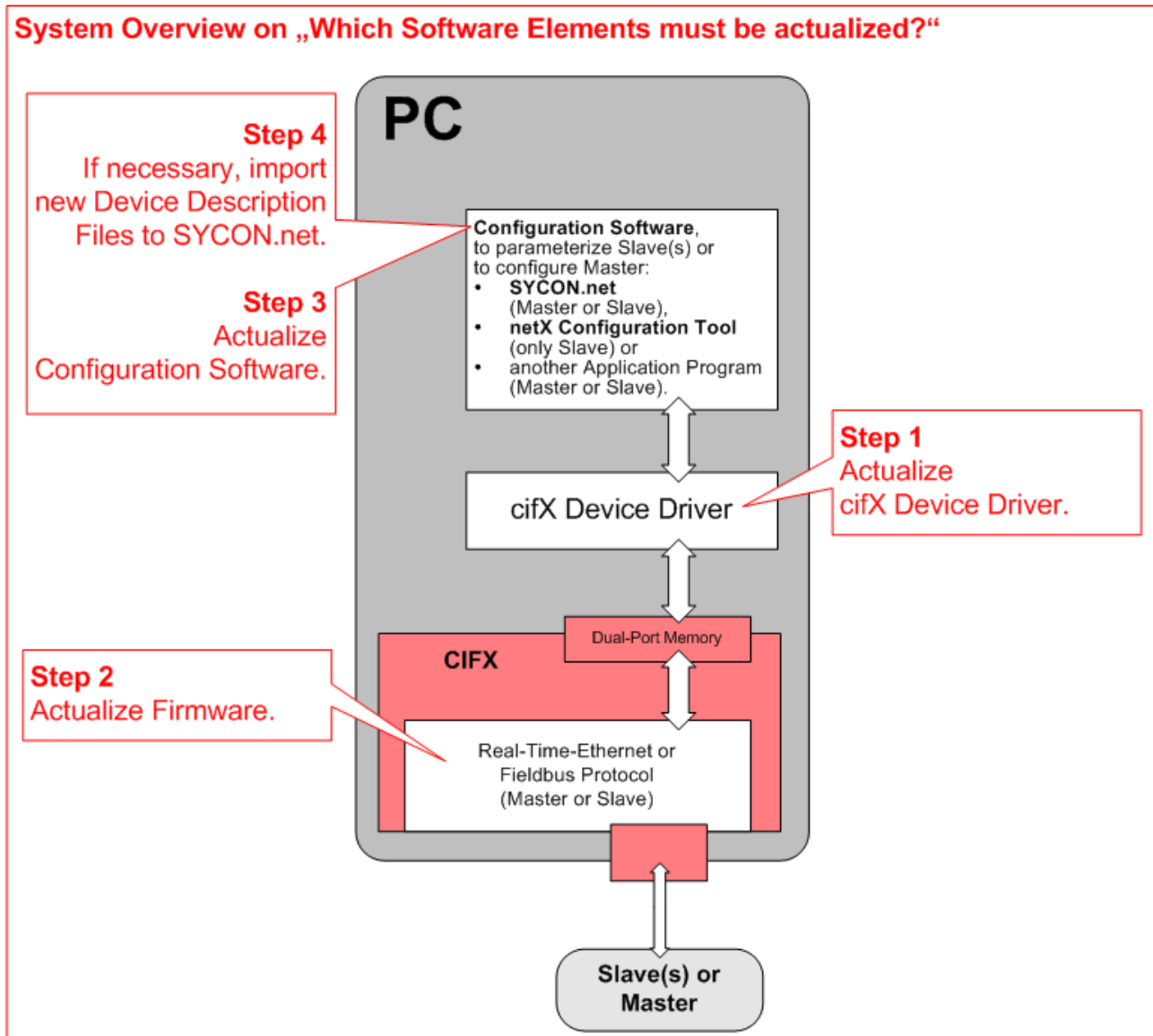

Figure 1: System Overview cifX to update Firmware, Driver and Software



Note the specific details for devices with **Rotary Switch Slot Number (Card ID)** in the section *The Function „Slot Number (Card ID)“* on page 29 or **DMA Mode** in section *The Function „DMA Mode“* on page 31.

5 Device Drawings

5.1 PC Cards cifX PCI and PCI Express

5.1.1 CIFX 50-RE, CIFX 50-RE\ET, CIFX 50E-RE, CIFX 50E-RE\ET

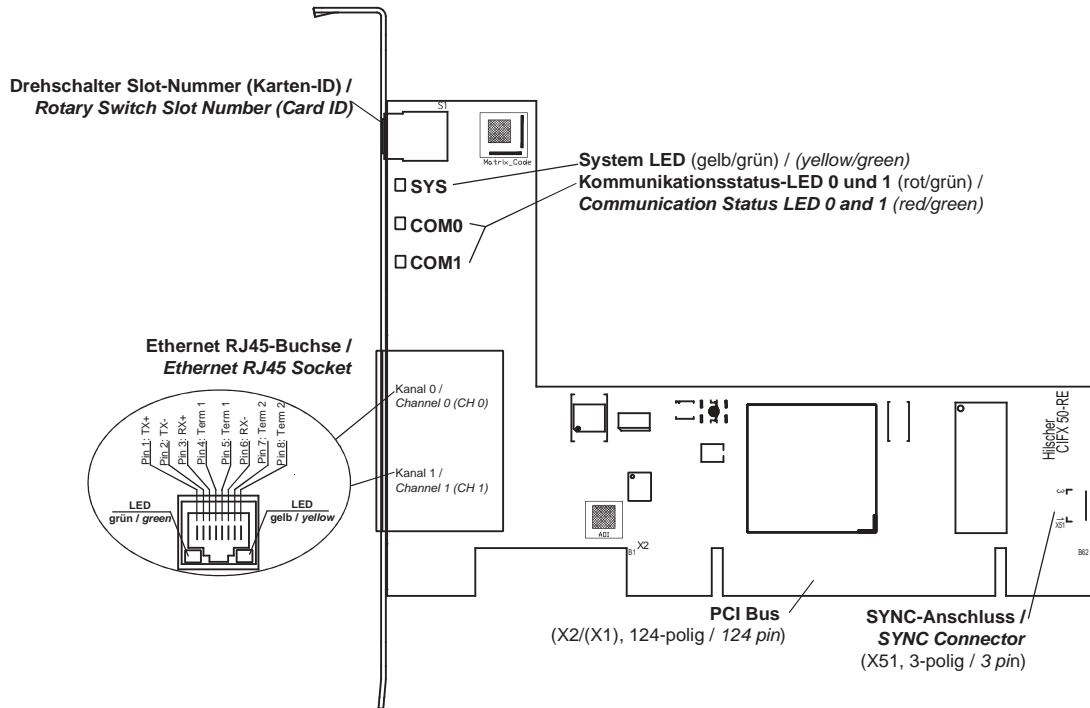

Figure 2: CIFX 50-RE* (from hardware rev. 3), CIFX 50-RE\ET* (from hardware rev. 1)

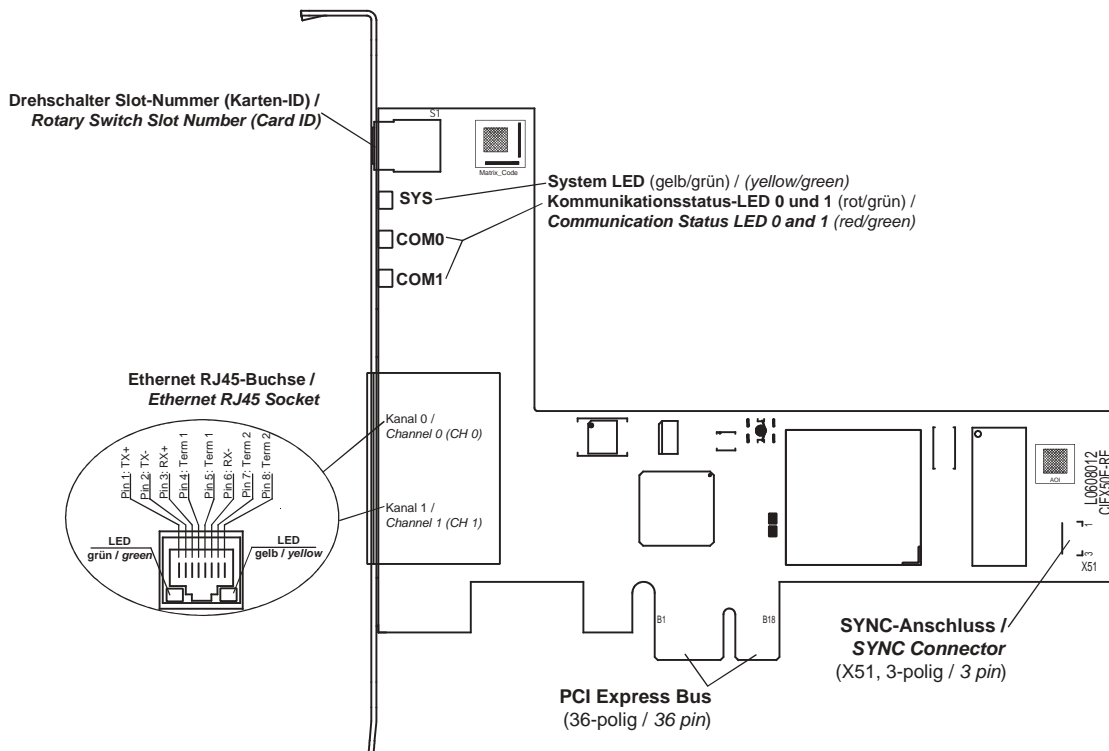

Figure 3: CIFX 50E-RE* (from hardware rev. 4), CIFX 50E-RE\ET* (from hardware rev. 1)



Note: *Device supports Auto Crossover Function. Note also: With loaded EtherCAT Master firmware only the RJ45 channel 0 can be used, channel 1 is deactivated. Beginning with EtherCAT Master firmware V3 channel 1 can be reactivated if redundancy is activated. For Open Modbus/TCP with V2.3.4.0 and higher both RJ45 channels can be used.



For the **SYNC** pin assignment of the SYNC Connector refer to section *Pin Assignment SYNC Connector, X51* (CIFX 50 50E 70E) on page 112. Device drawings of earlier device revisions without rotary switch slot number (card ID) are included in the user manual for PC cards cifX Real-Time Ethernet up to manual rev. 32.

The figure below shows the front plate of the PC cards CIFX 50-RE, CIFX 50-RE\ET, CIFX 50E-RE or CIFX 50E-RE\ET:

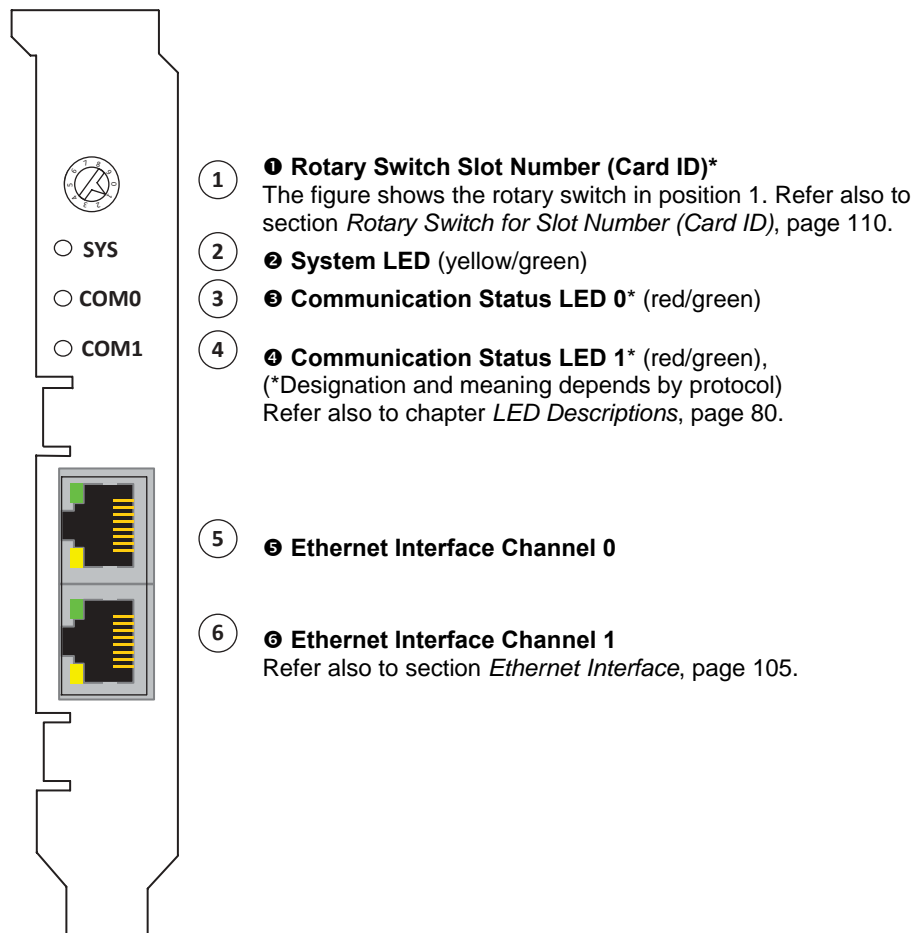

Figure 4: Front Plate for CIFX 50-RE, CIFX 50-RE\ET, CIFX 50E-RE or CIFX 50E-RE\ET

*From hardware revision 3 (for CIFX 50-RE), 1 (for CIFX 50-RE\ET), 4 (for CIFX 50E-RE) or 1 (for CIFX 50E-RE\ET) on, the **Rotary Switch Slot Number (Card ID)** is provided.

5.1.2 CIFX 50-DP, CIFX 50E-DP

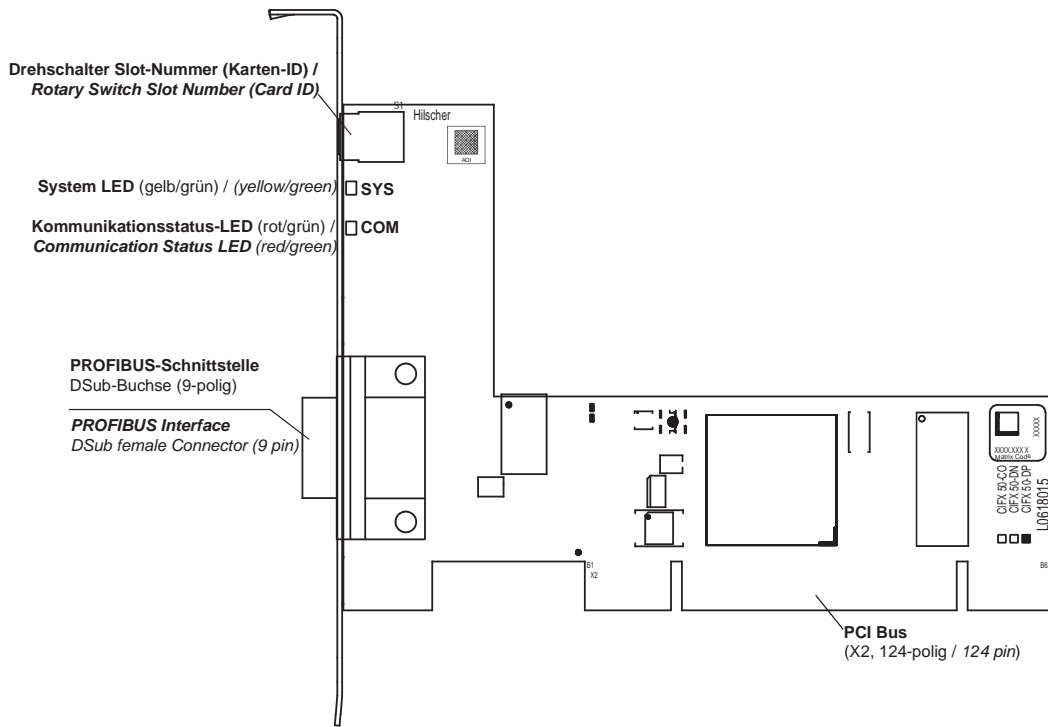

Figure 5: CIFX 50-DP (hardware revision 5)*

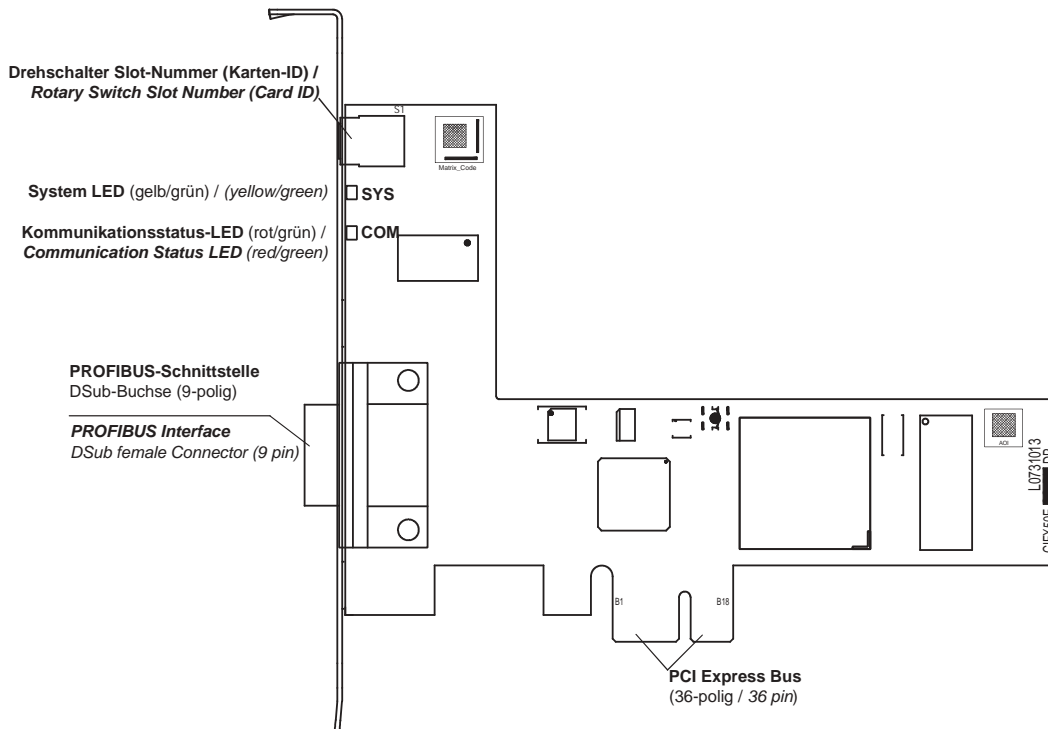

Figure 6: CIFX 50E-DP (hardware revision 5)*



*Device drawings of earlier device revisions without rotary switch slot number (card ID) or with two COM LEDs are included in the user manual for PC cards cifX fieldbus up to manual rev. 23.

The figure below shows the front plate of the PC cards CIFX 50-DP or CIFX 50E-DP:

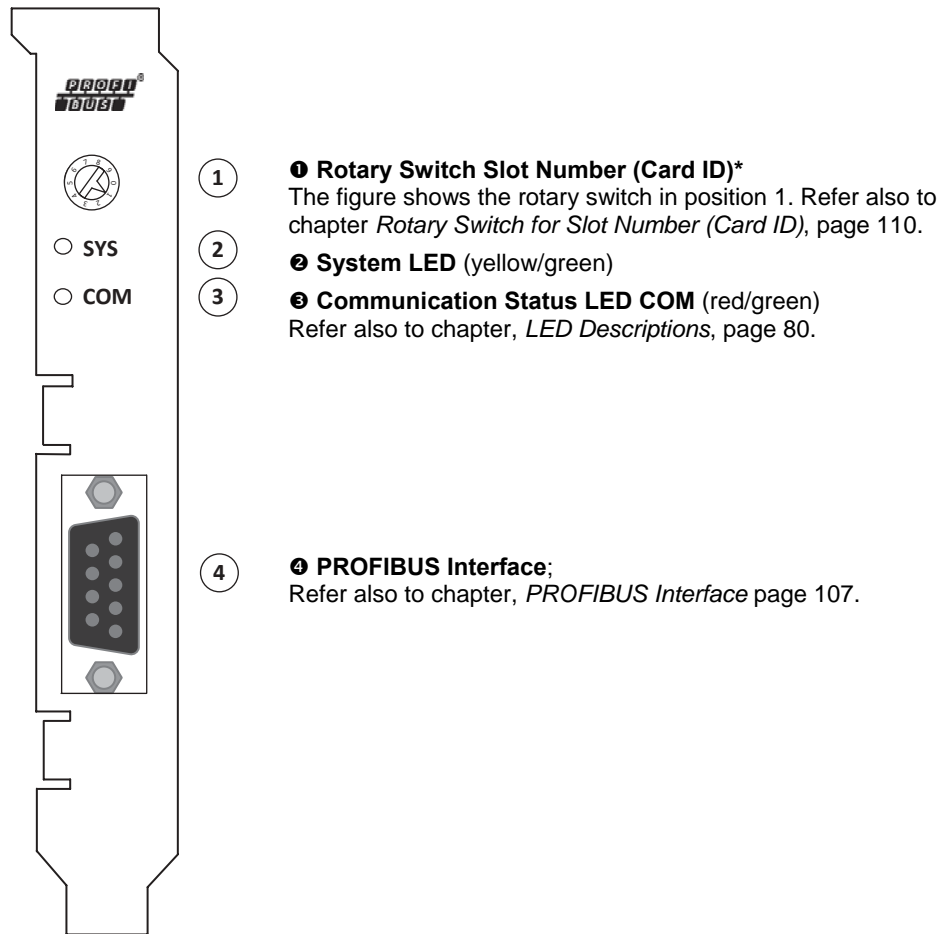
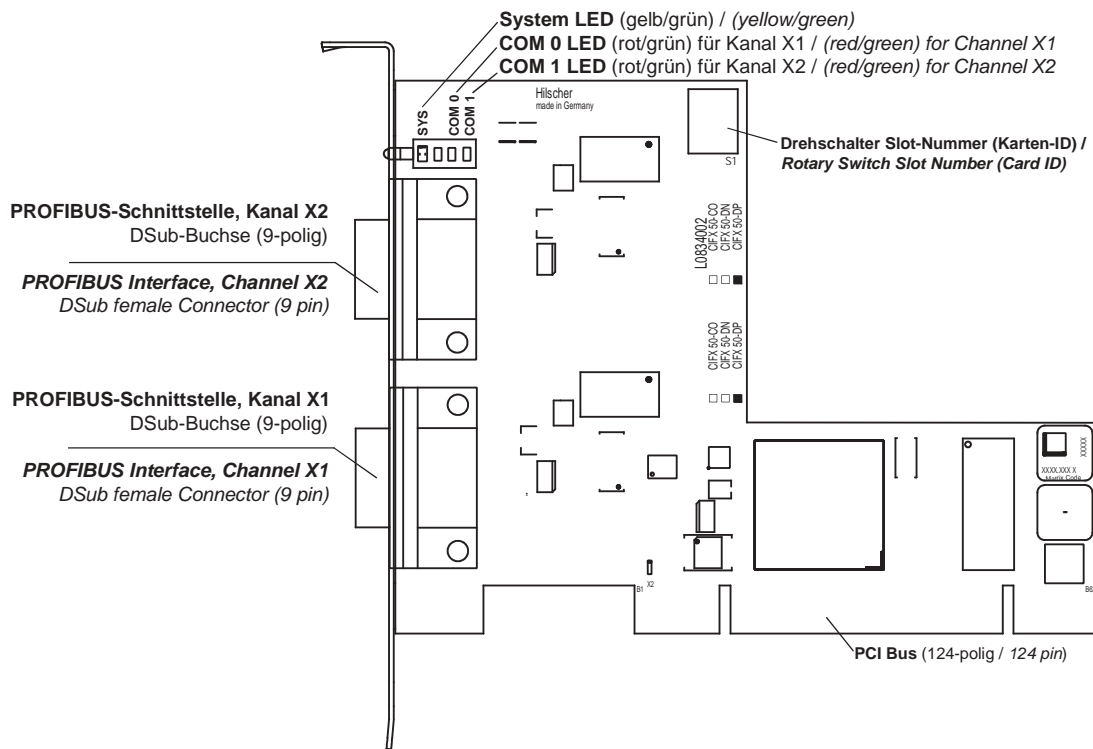

Figure 7: Front Plate CIFX 50-DP or CIFX 50E-DP

*From hardware revision 5 (for CIFX 50-DP or CIFX 50E-DP) on, the **Rotary Switch Slot Number (Card ID)** is provided.

5.1.3 CIFX 50-2DP



A Device drawing of the earlier device revision without rotary switch slot number (card ID) is included in the user manual rev. 37.

Figure 8: CIFX 50-2DP (Hardware Revision 3)

The figure below shows the front plate of the PC cards CIFX 50-2DP:

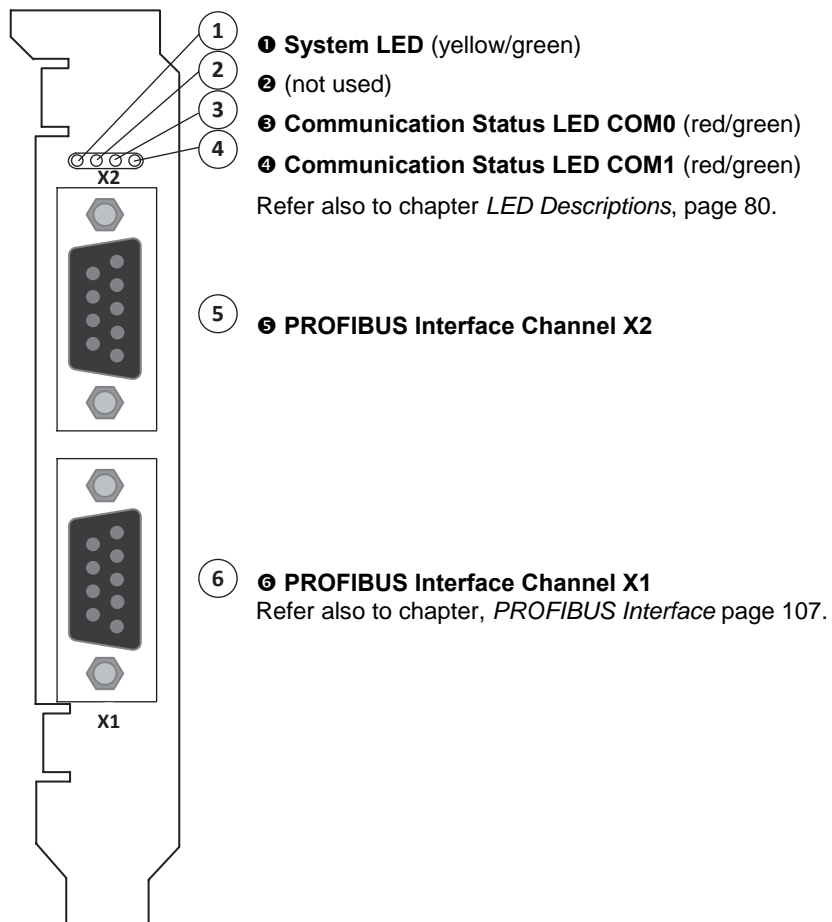

Figure 9: Front Plate CIFX 50-2DP

5.1.4 CIFX 50-2DP\CO

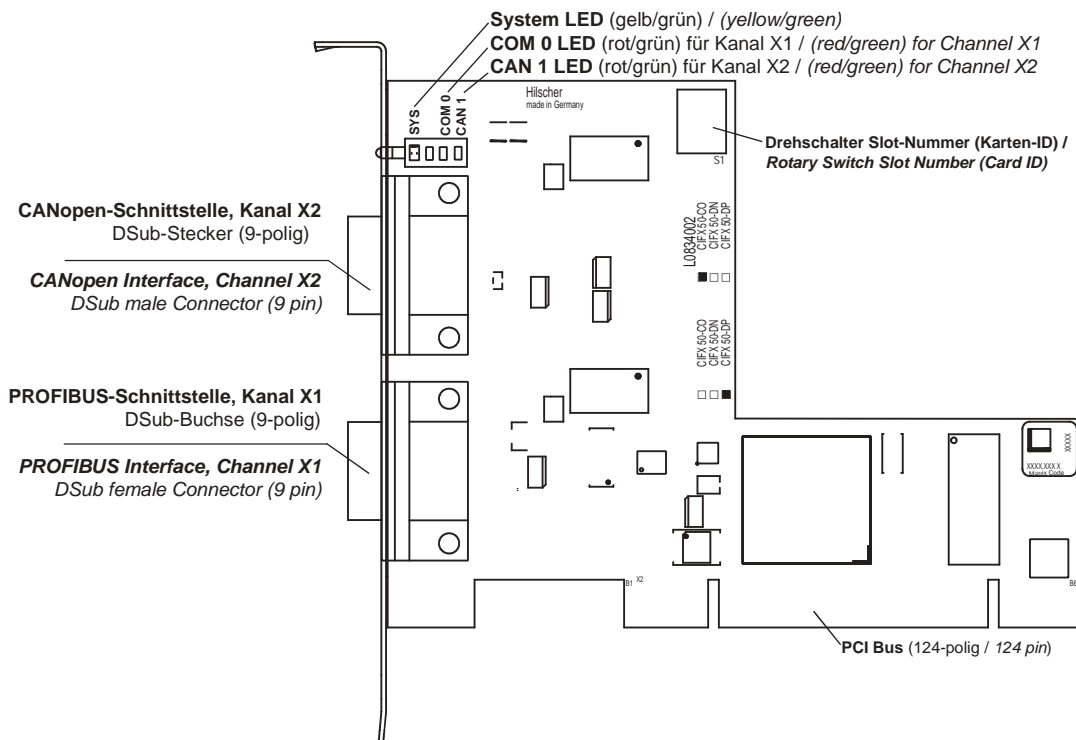

Figure 10: CIFX 50-2DP\CO (Hardware Revision 2)

The figure below shows the front plate of the PC cards CIFX 50-2DP\CO:

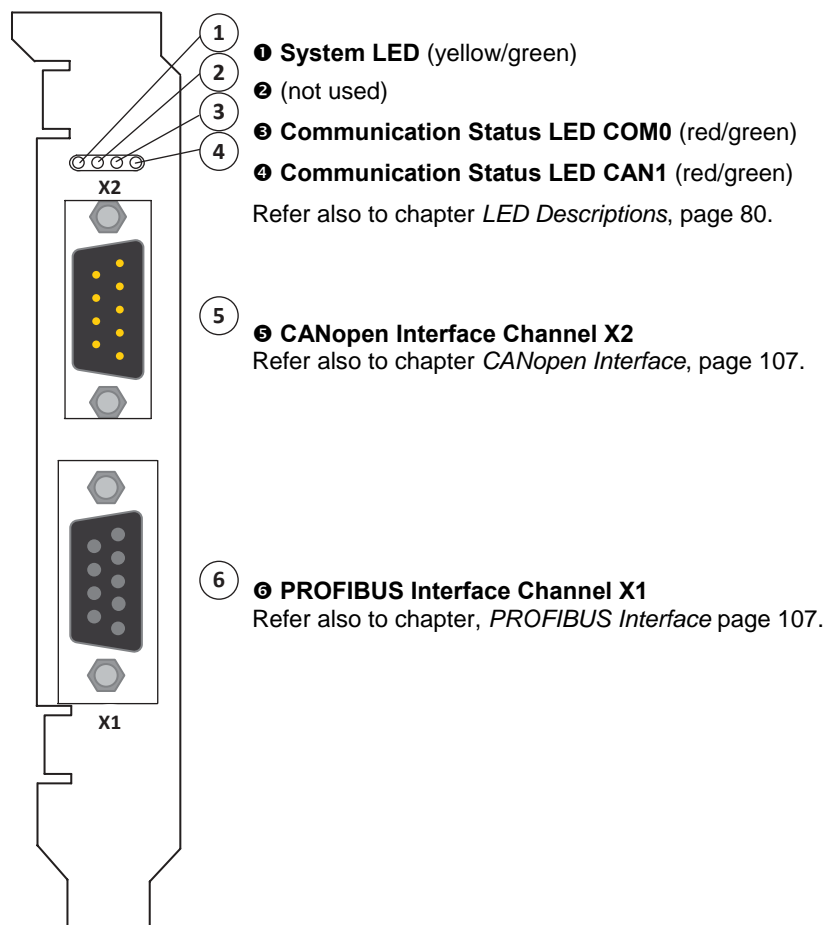

Figure 11: Front Plate CIFX 50-2DP\CO

5.1.5 CIFX 50-2DP\DN

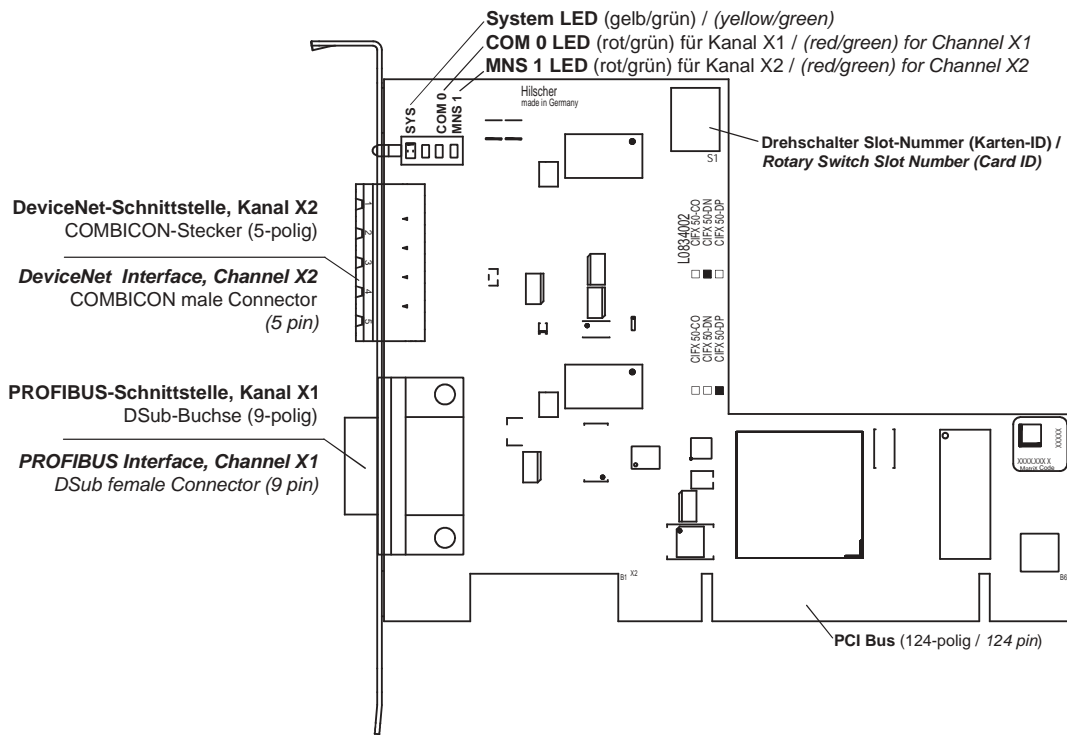

Figure 12: CIFX 50-2DP\DN (Hardware Revision 1)

The figure below shows the front plate of the PC cards CIFX 50-2DP\DN:

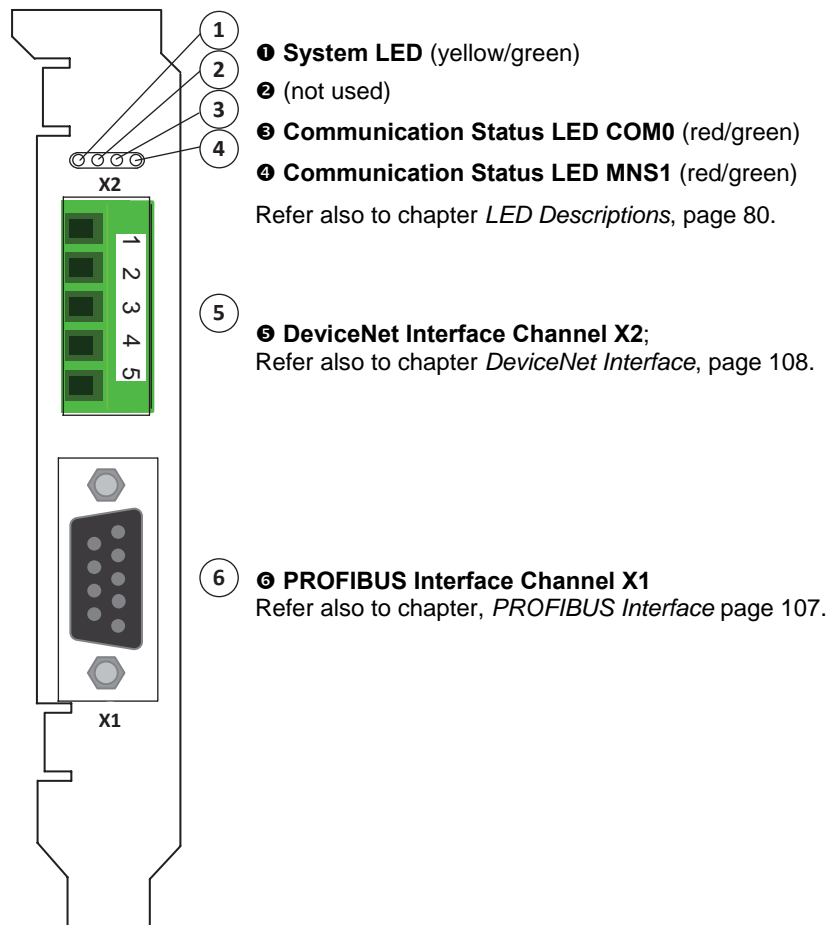

Figure 13: Front Plate CIFX 50-2DP\DN

5.1.6 CIFX 50-CO, CIFX 50E-CO

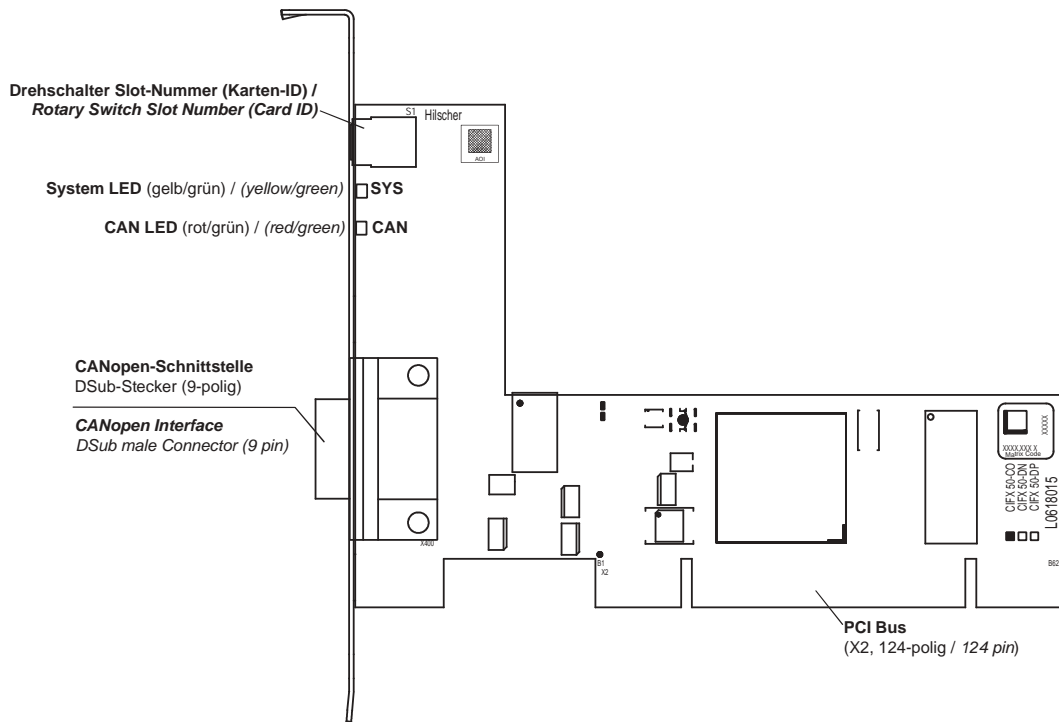

Figure 14: CIFX 50-CO (hardware revision 5)

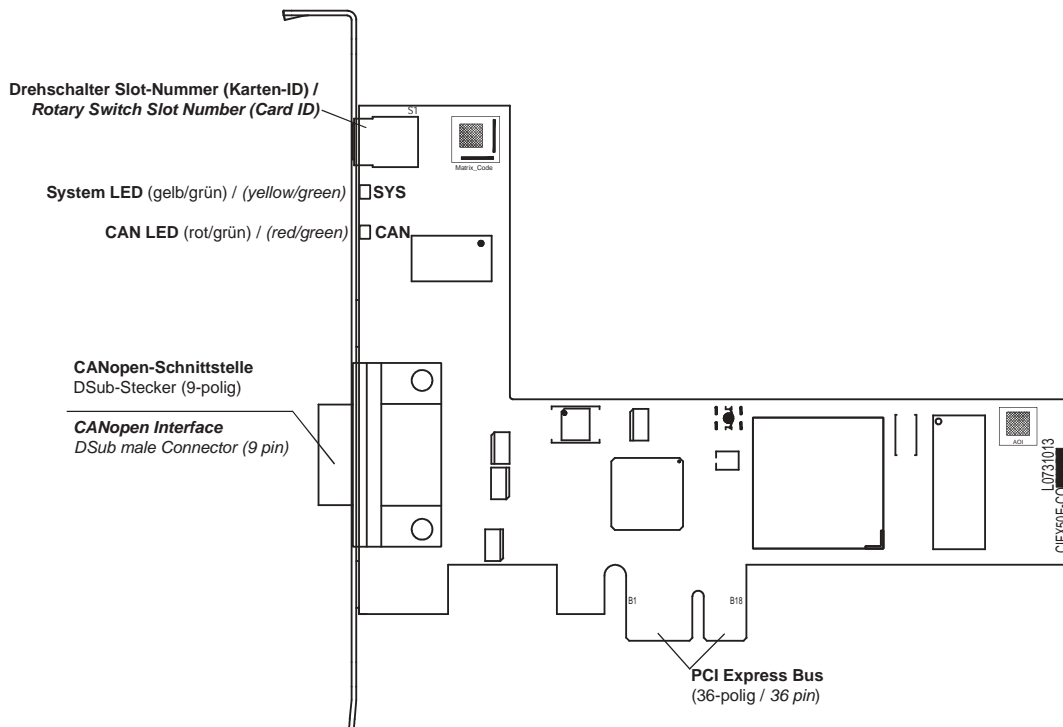

Figure 15: CIFX 50E-CO (from hardware revision 4)



Device drawings of earlier device revisions without rotary switch slot number (card ID) or with two COM LEDs are included in the user manual for PC cards cifX fieldbus up to manual rev. 23.

The figure below shows the front plate of the PC cards CIFX 50-CO or CIFX 50E-CO:

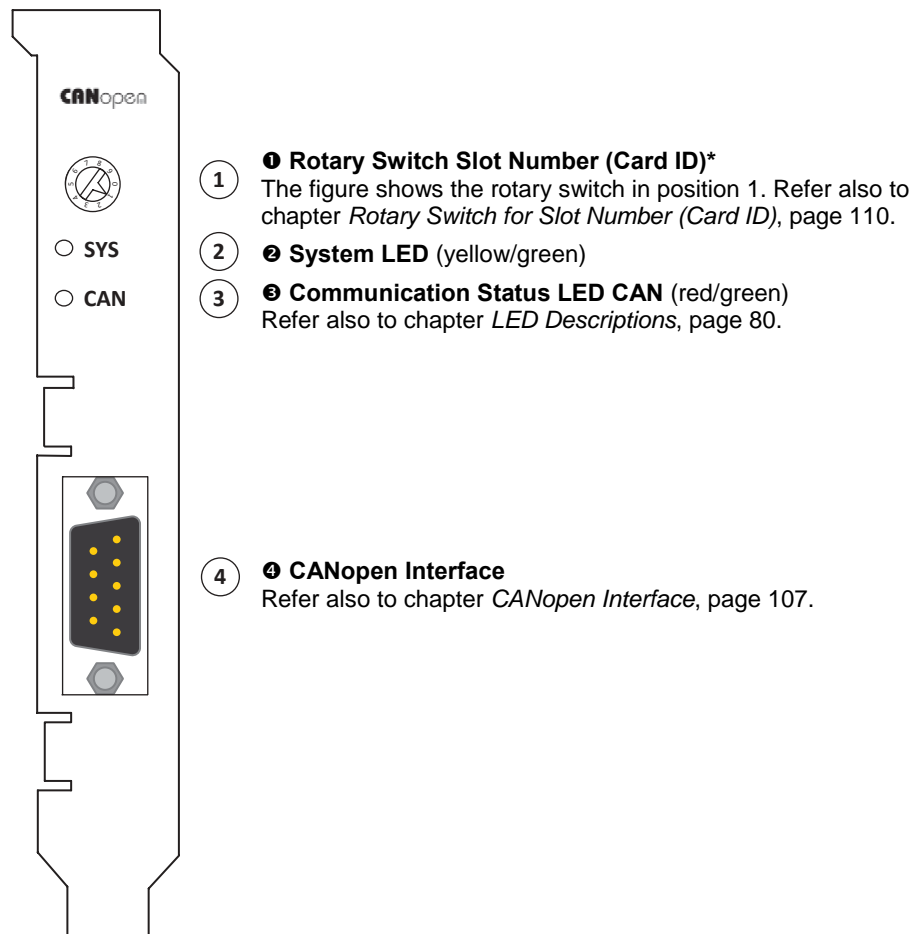

Figure 16: Front Plate for CIFX 50-CO or CIFX 50E-CO

*From hardware revision 5 (for CIFX 50-CO or CIFX 50E-CO) on, the **Rotary Switch Slot Number (Card ID)** is provided.

5.1.7 CIFX 50-2CO

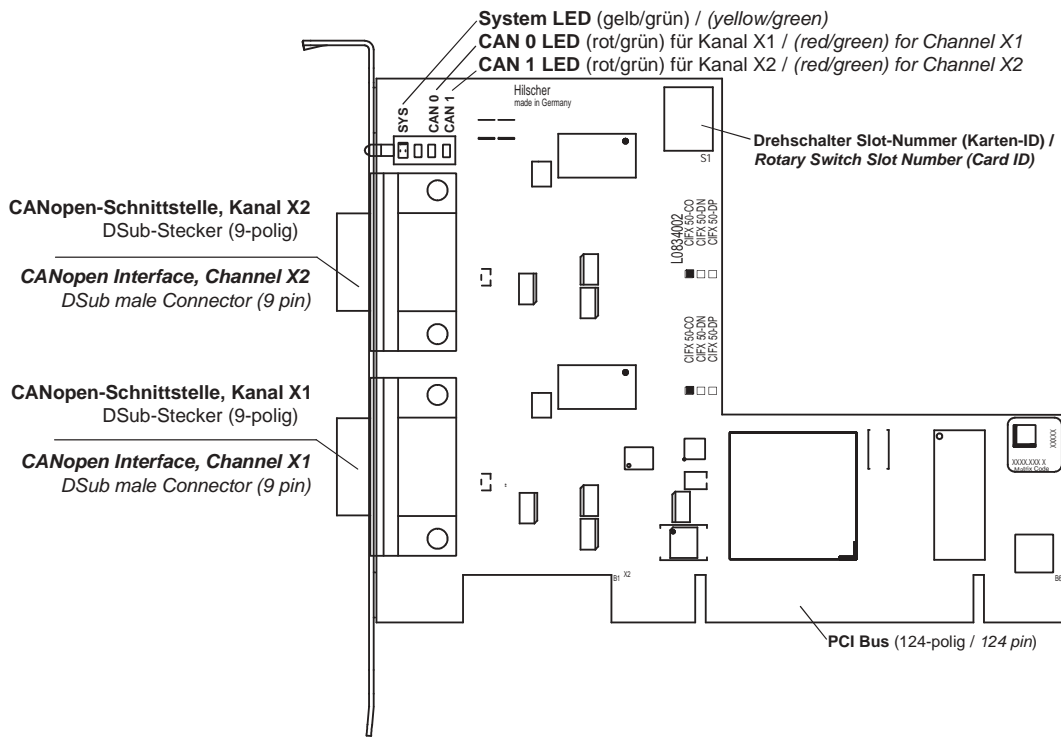

Figure 17: CIFX 50-2CO (Hardware Revision 2)

The figure below shows the front plate of the PC cards CIFX 50-2CO:

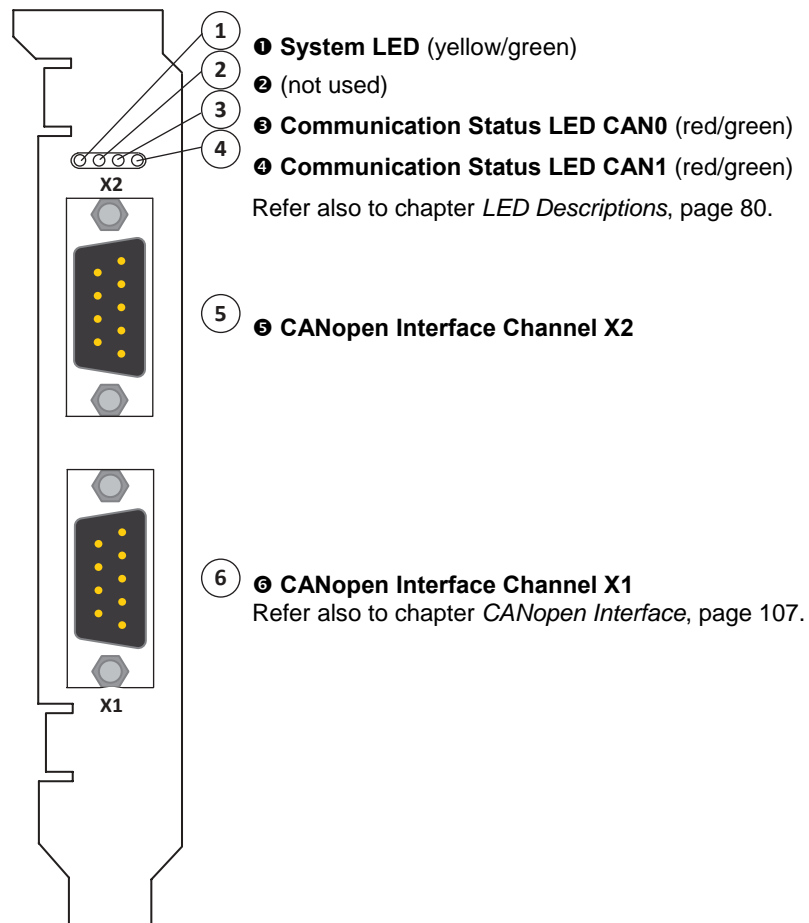

Figure 18: Front Plate CIFX 50-2CO

5.1.8 CIFX 50-2CO\DN

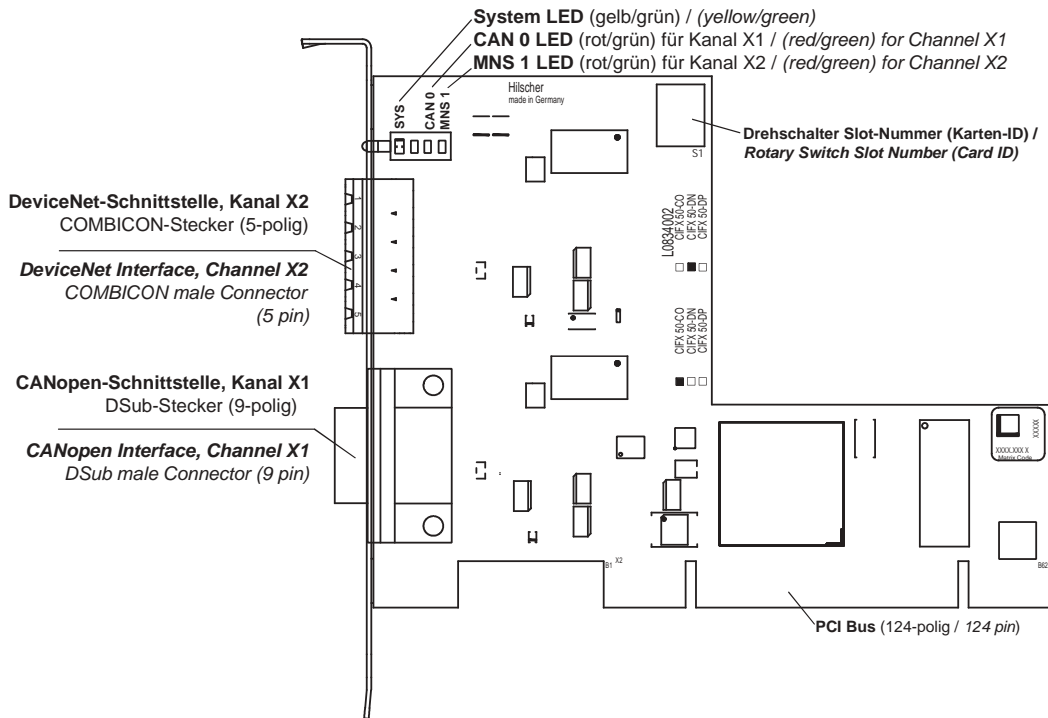

Figure 19: CIFX 50-2 CO\DN (Hardware Revision 1)

The figure below shows the front plate of the PC cards CIFX 50-2CO\DN:

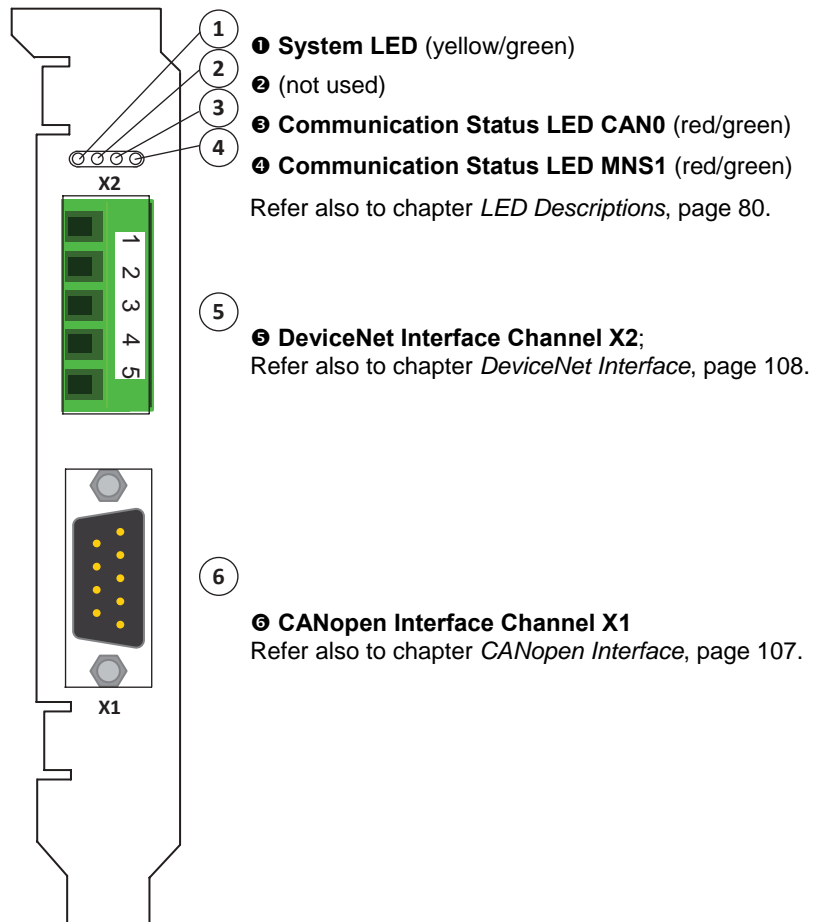

Figure 20: Front Plate CIFX 50-2CO\DN

5.1.9 CIFX 50-DN, CIFX 50E-DN

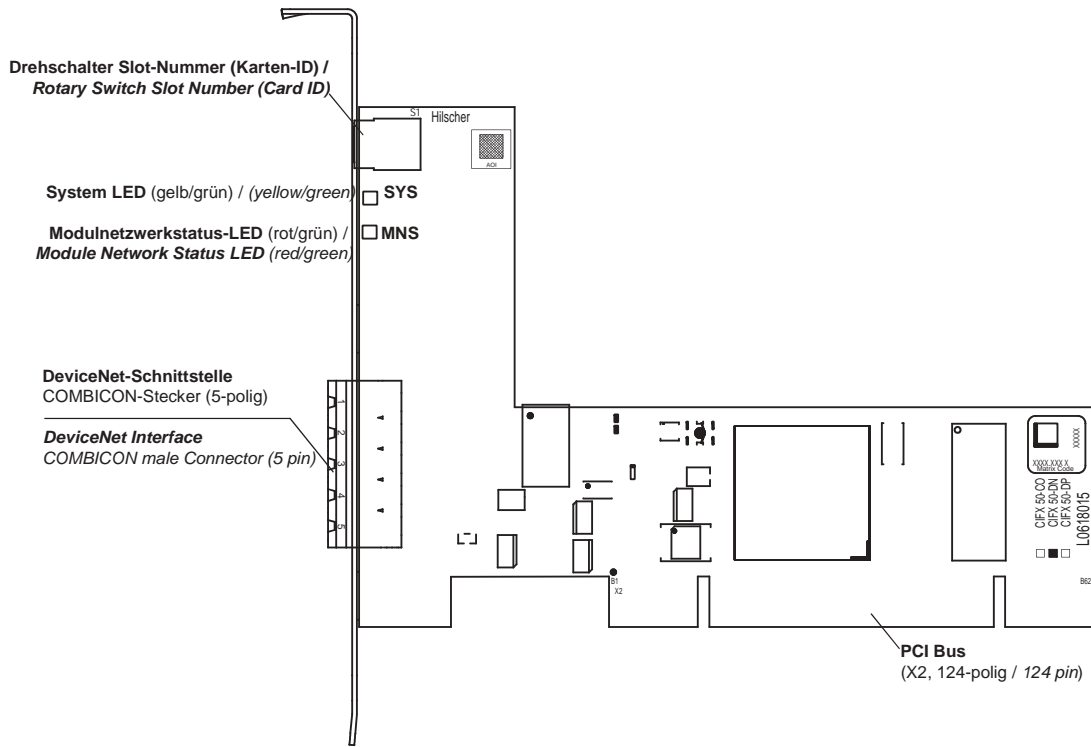

Figure 21: CIFX 50-DN (hardware revision 5)

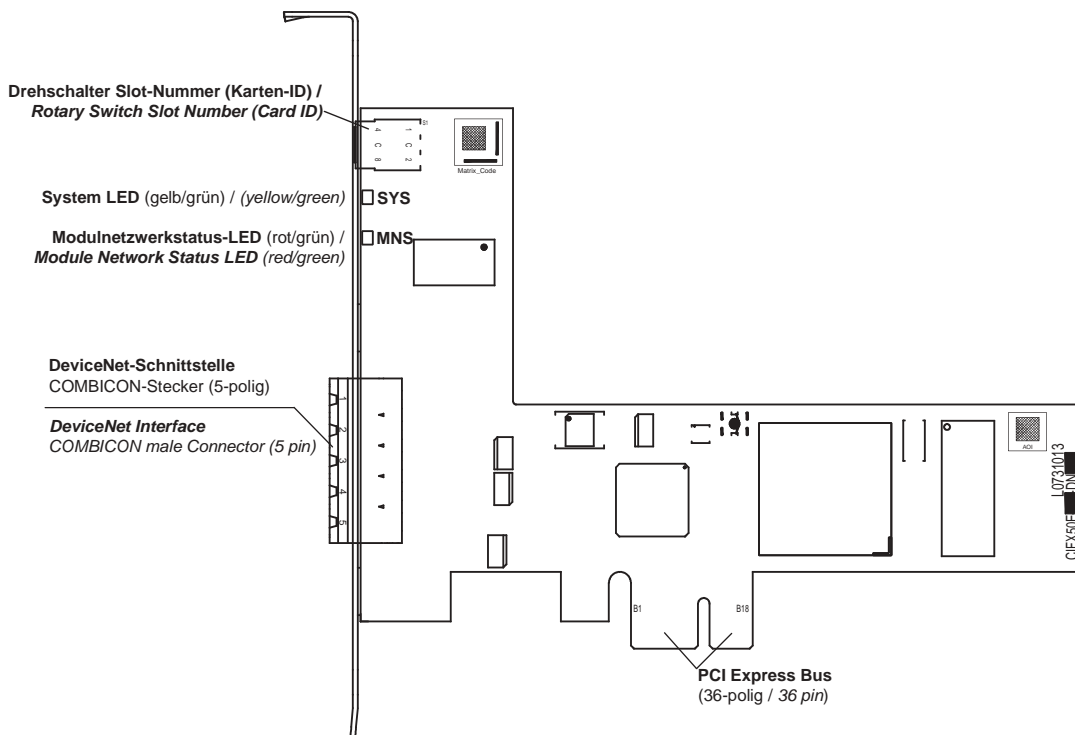

Figure 22: CIFX 50E-DN (from hardware revision 4)



Device drawings of earlier device revisions without rotary switch slot number (card ID) are included in the user manual for PC cards cifX fieldbus up to manual rev. 23.

The figure below shows the front plate of the PC cards CIFX 50-DN or CIFX 50E-DN:

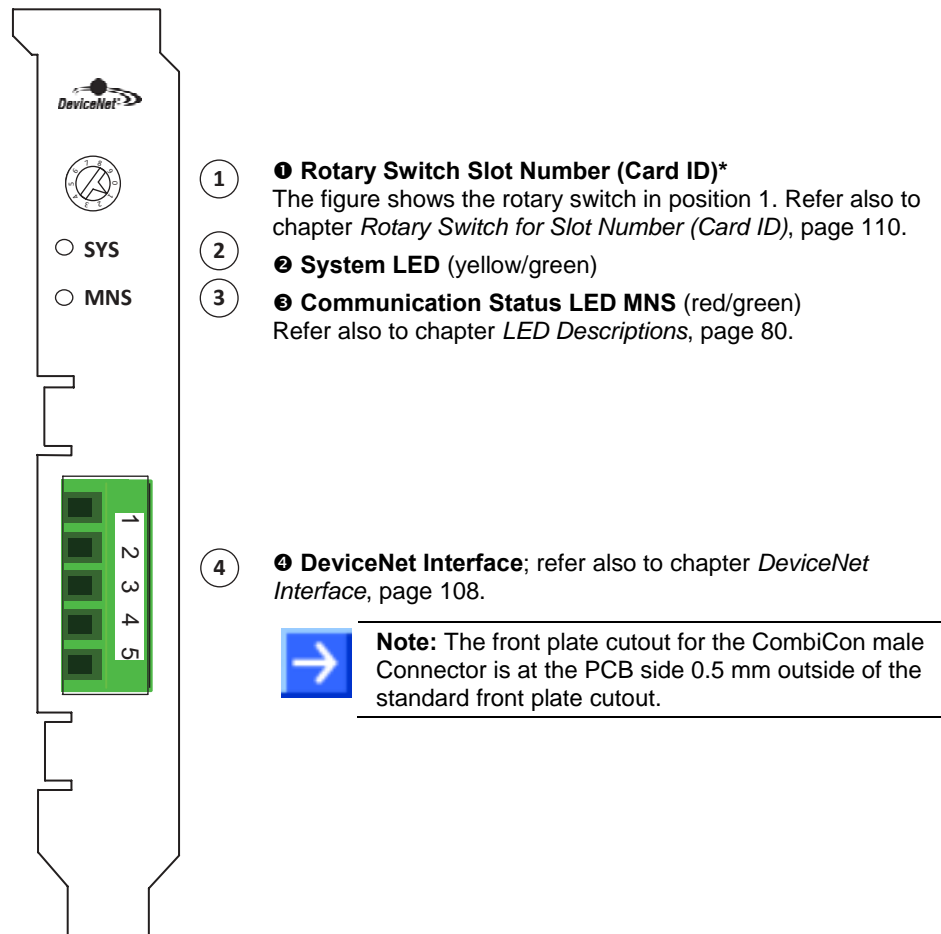

Figure 23: Front Plate CIFX 50-DN or CIFX 50E-DN

*From hardware revision 5 (for CIFX 50-DN or CIFX 50E-DN on, the **Rotary Switch Slot Number (Card ID)** is provided.

5.1.10 CIFX 50-2DN

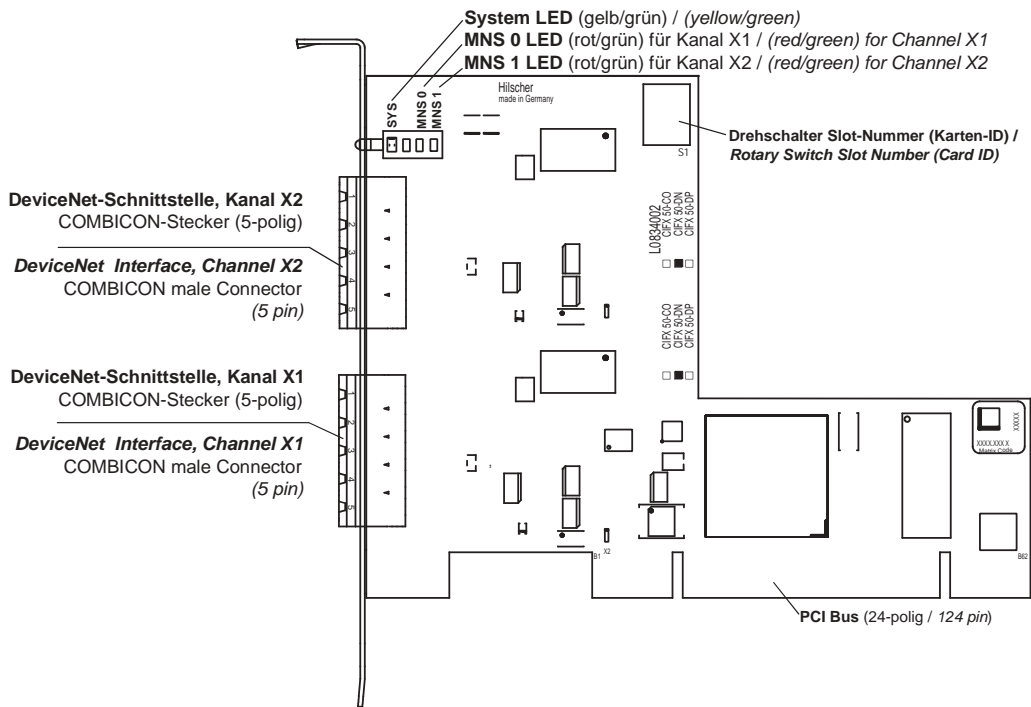

Figure 24: CIFX 50-2DN (Hardware Revision 2)

The figure below shows the front plate of the PC cards CIFX 50-2DN:

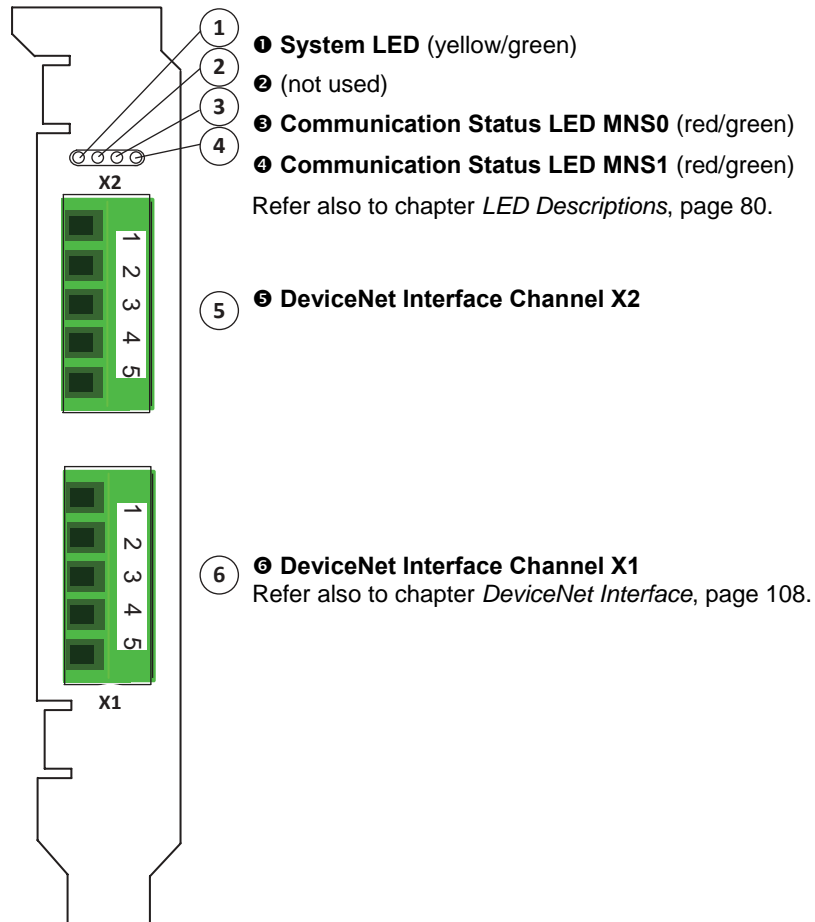

Figure 25: Front Plate CIFX 50-2DN

5.1.11 CIFX 50-2ASM, CIFX 50E-2ASM

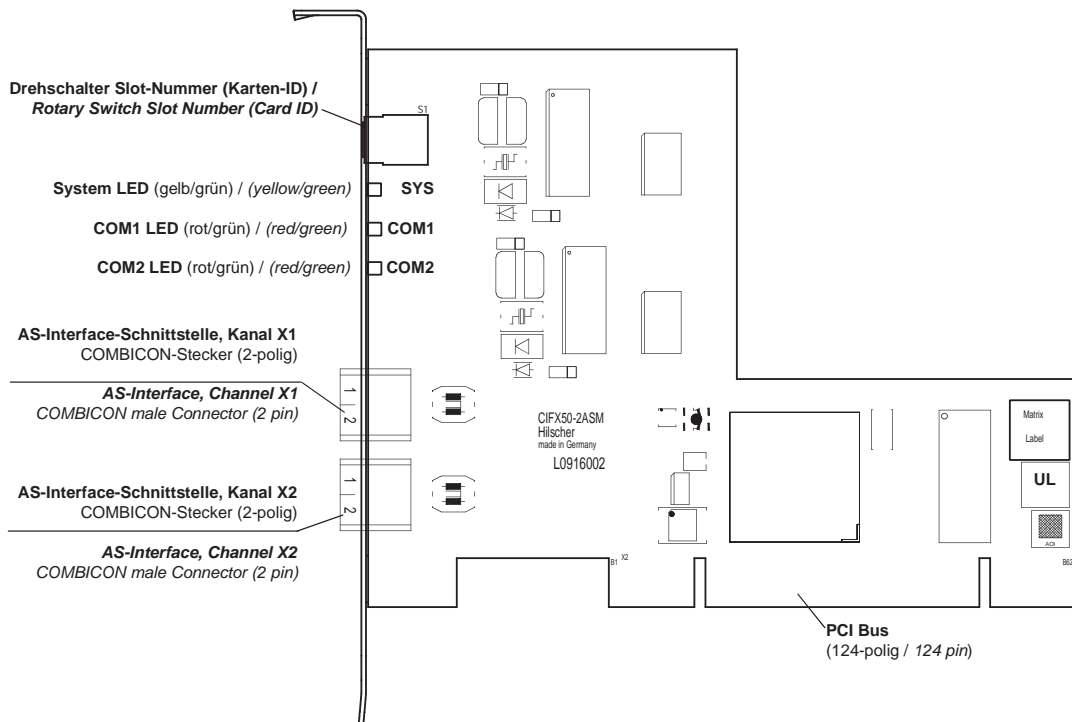

Figure 26: CIFX 50-2ASM (hardware revision 2)

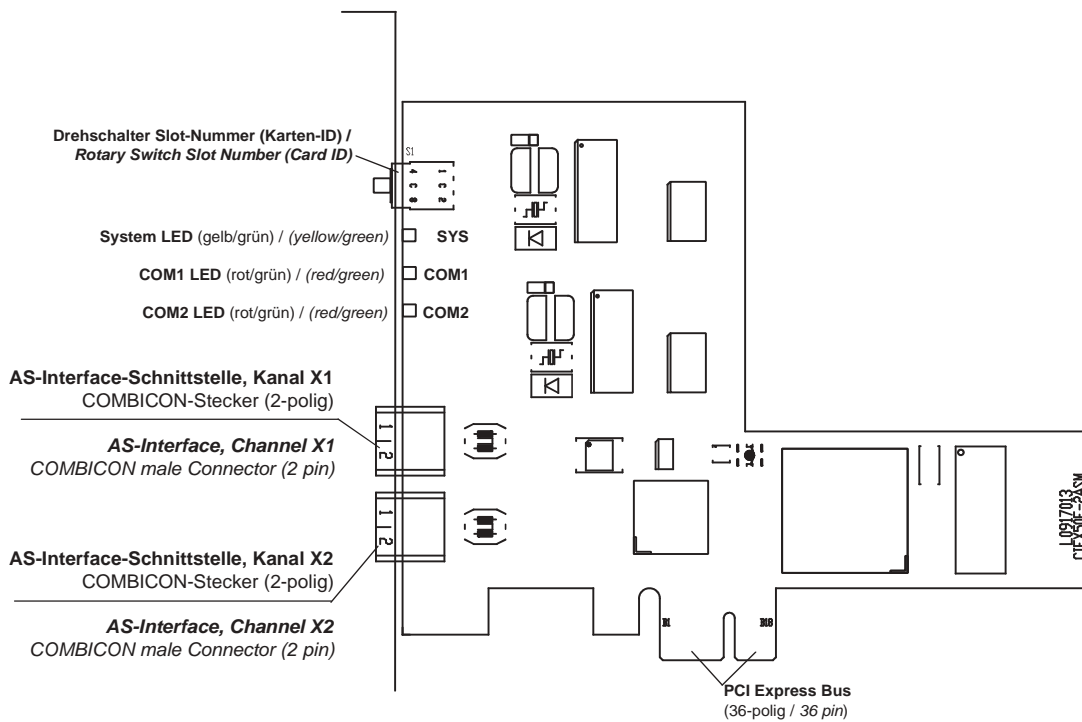

Figure 27: CIFX 50E-2ASM (from hardware revision 2)



Device drawings of earlier device revisions without rotary switch slot number (card ID) are included in the user manual for PC cards cifX fieldbus up to manual rev. 23.

The figure below shows the front plate of the PC card CIFX 50-2ASM:

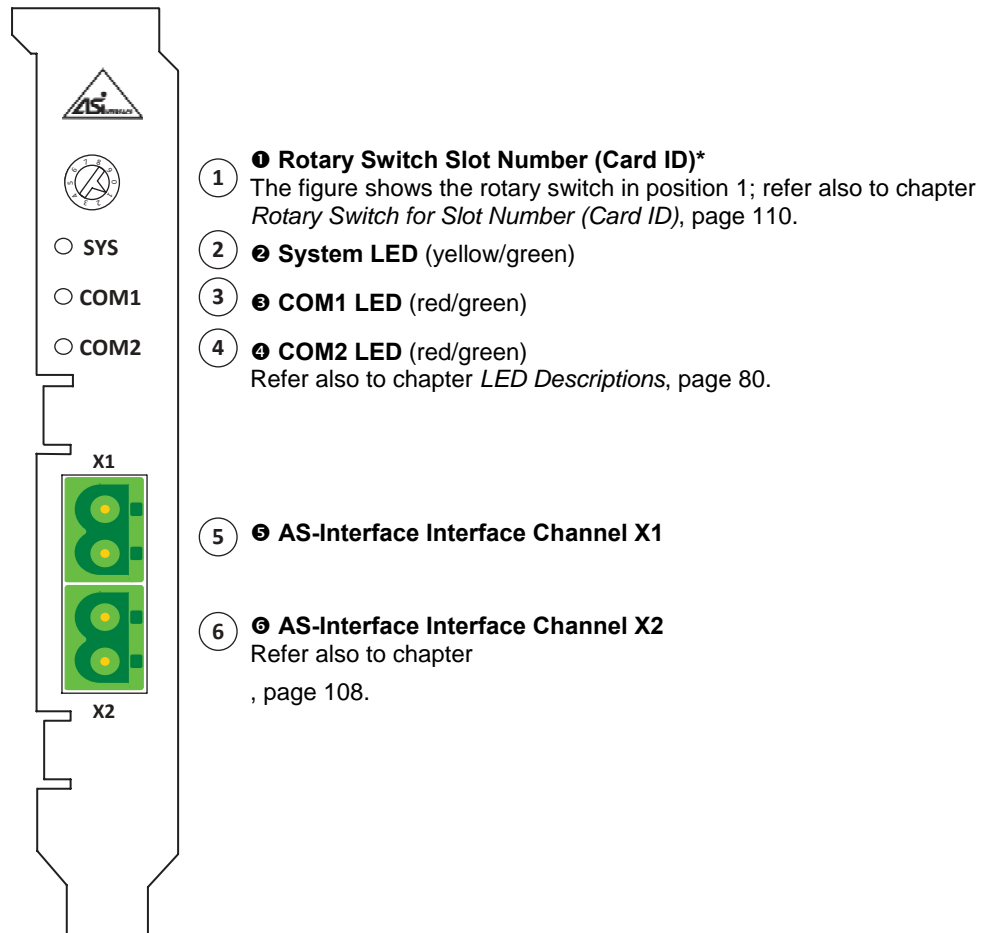

Figure 28: Front Plate CIFX 50-2ASM

*From hardware revision 2 on, the **Rotary Switch Slot Number (Card ID)** is provided.

5.1.12 CIFX 50-CC, CIFX 50E-CC

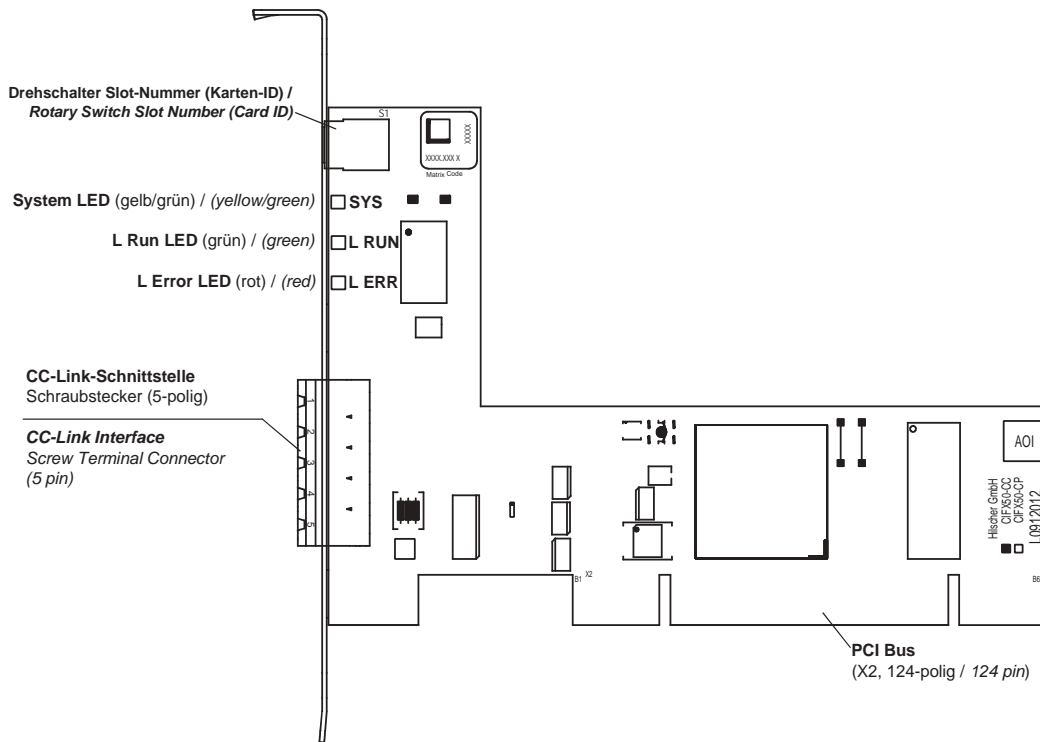

Figure 29: CIFX 50-CC (hardware revision 2)*

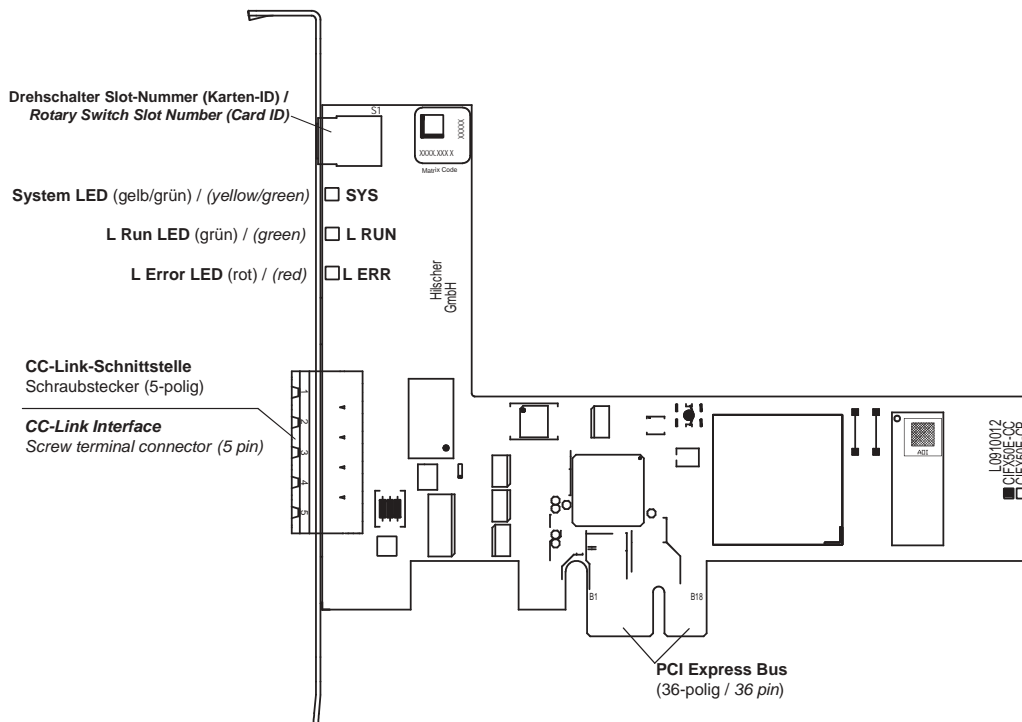

Figure 30: CIFX 50E-CC (hardware revision 4)*



Device drawings of earlier device revisions without rotary switch slot number (card ID) are included in the user manual for PC cards cifX fieldbus up to manual rev. 23.



Note: *The front plate cutout for the screw terminal connector is at the PCB side 0.5 mm outside of the standard front plate cutout.

The figure below shows the front plate of the PC cards CIFX 50-CC or CIFX 50E-CC:

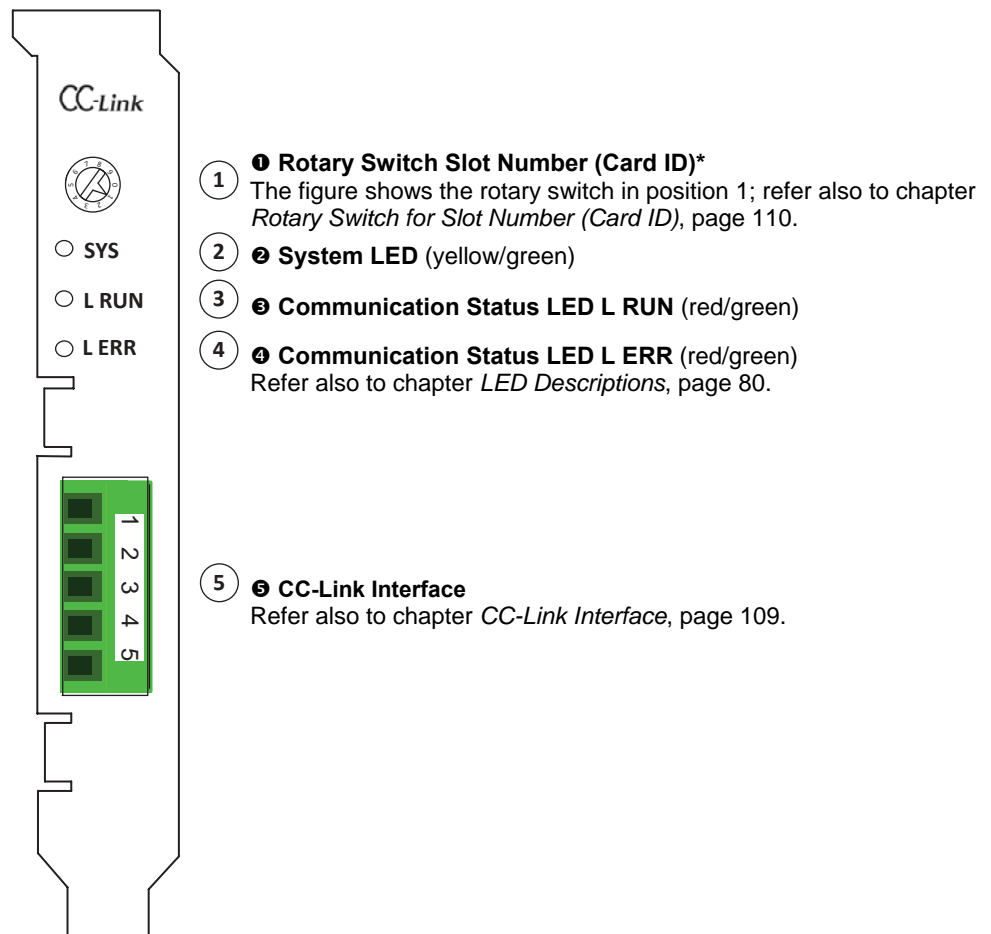

Figure 31: Front Plate CIFX 50-CC or CIFX 50E-CC

*From hardware revision 2 (for CIFX 50-CC) on or 3 (for CIFX 50E-CC), the **Rotary Switch Slot Number (Card ID)** is provided.

5.1.13 Meaning of the Front Panel Inscriptions for 2 Channel Devices

	Channel X1	Channel X2
CIFX 50-2DP	COM0	COM1
CIFX 50-2DP\CO	COM0	CAN1
CIFX 50-2DP\DN	COM0	MNS1
CIFX 50-2CO	CAN0	CAN1
CIFX 50-2CO\DN	CAN0	MNS1
CIFX 50-2DN	MNS0	MNS1
CIFX 50-2ASM	COM1	COM2
CIFX 50E-2ASM	COM1	COM2

Table 27: Assignment of the LEDs to the Channels

X1 and X2 indicate the bus interfaces: X1 stands for fieldbus 1 (channel X1), X2 stands for fieldbus 2 (channel X2).



Note: Within the configuration software SYCON.net the communication channels are named with 'Ch0', 'Ch1'

5.2 PC Cards cifX Low Profile PCI Express

5.2.1 CIFX 70E-RE, CIFX 70E-RE/MR

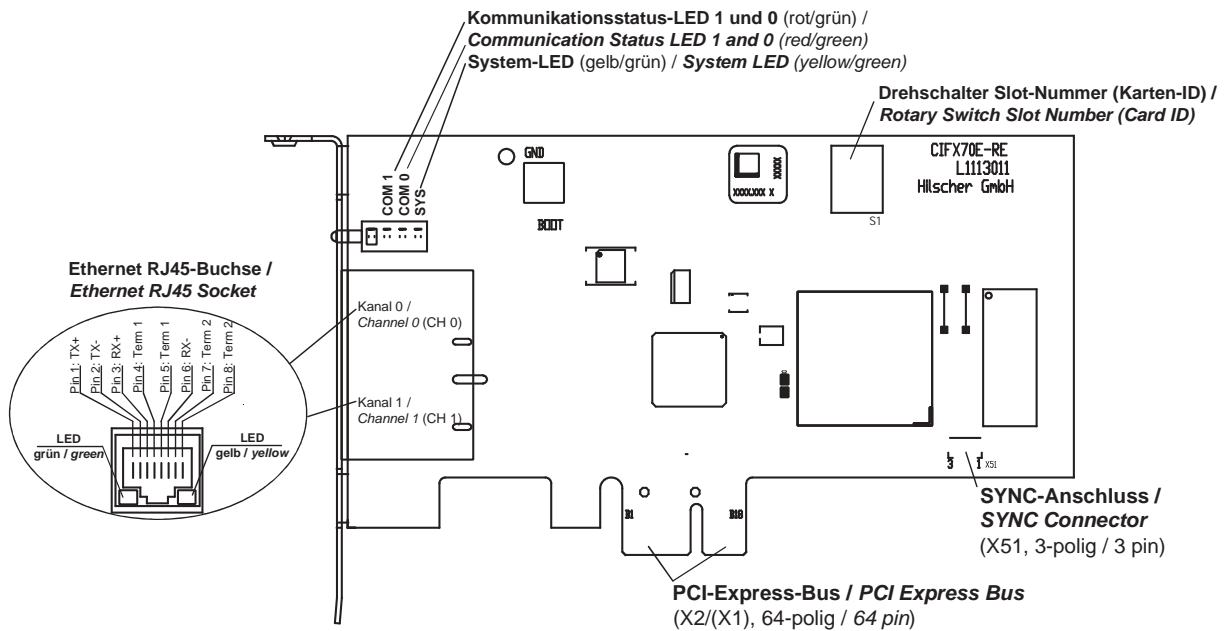

Figure 32: CIFX 70E-RE* (Hardware revision 1)

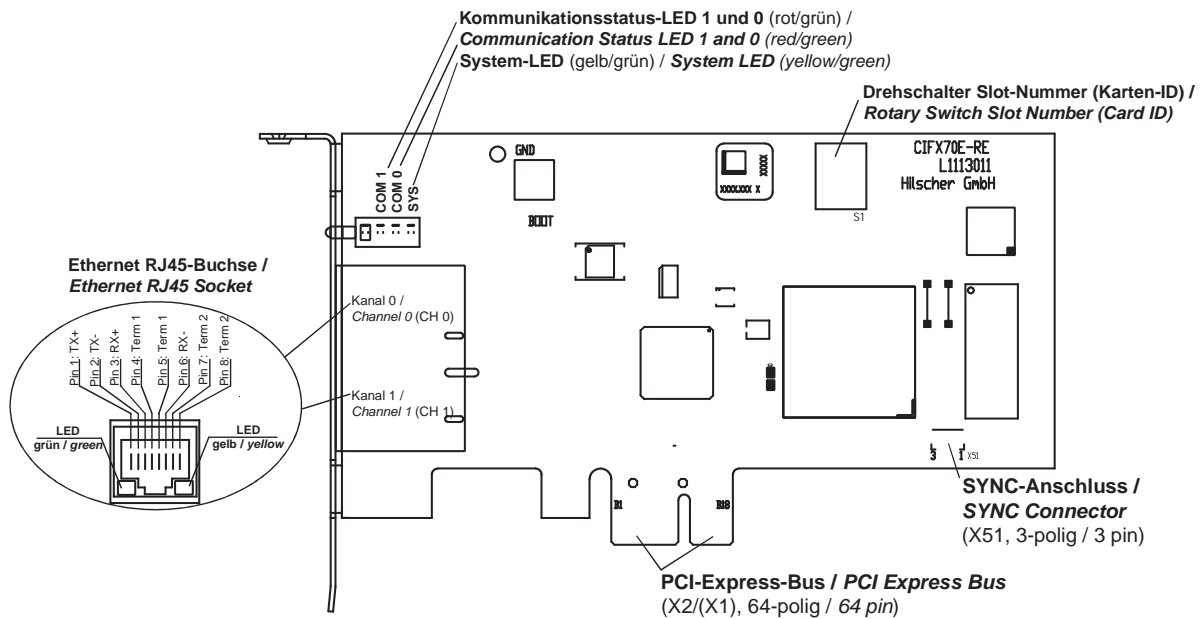

Figure 33: CIFX 70E-RE/MR* (Hardware revision 1)



Note: *Device supports Auto Crossover Function. Note also: With loaded EtherCAT Master firmware only the RJ45 channel 0 can be used, channel 1 is deactivated. Beginning with the EtherCAT Master firmware version 3 channel 1 can be reactivated if redundancy is activated. For Open Modbus/TCP with V2.3.4.0 and higher both RJ45 channels can be used.



. About **Rotary Switch for Slot Number (Card ID)** refer to section *Rotary Switch for Slot Number (Card ID)*, on page 110.

For the **SYNC** pin assignment of the SYNC Connector refer to section *Pin Assignment SYNC Connector, X51 (CIFX 50 50E 70E)* on page 112.

The figure below shows the front plate of the PC card CIFX 70E-RE or , CIFX 70E-REMR:

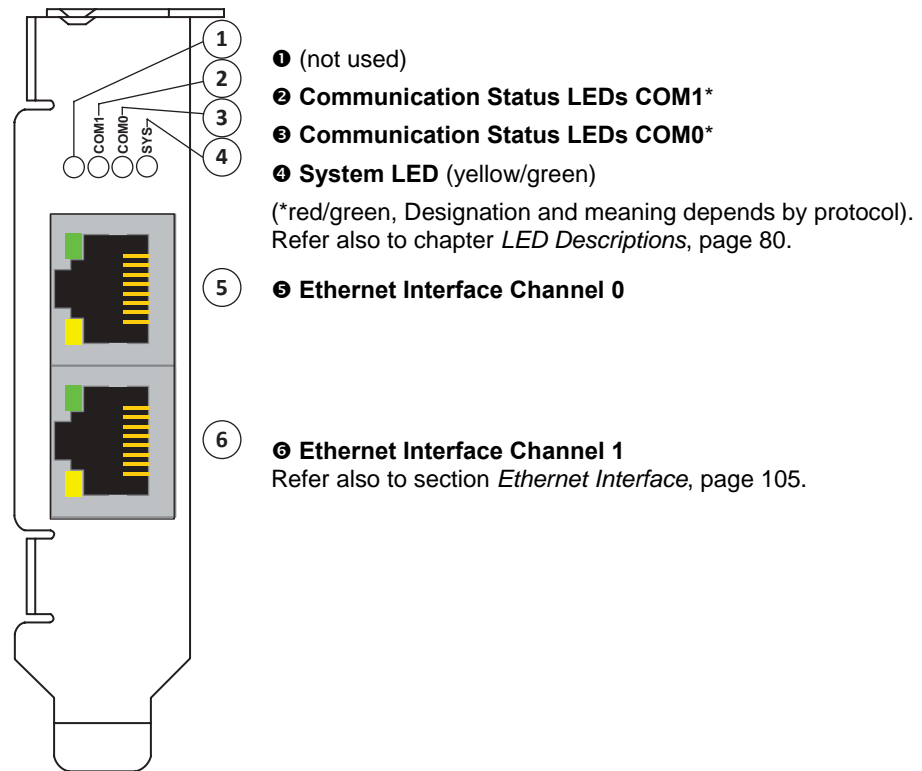

Figure 34: Front Plate for CIFX 70E-RE, CIFX 70E-REMR

5.2.2 CIFX 100EH-RE\CUBE

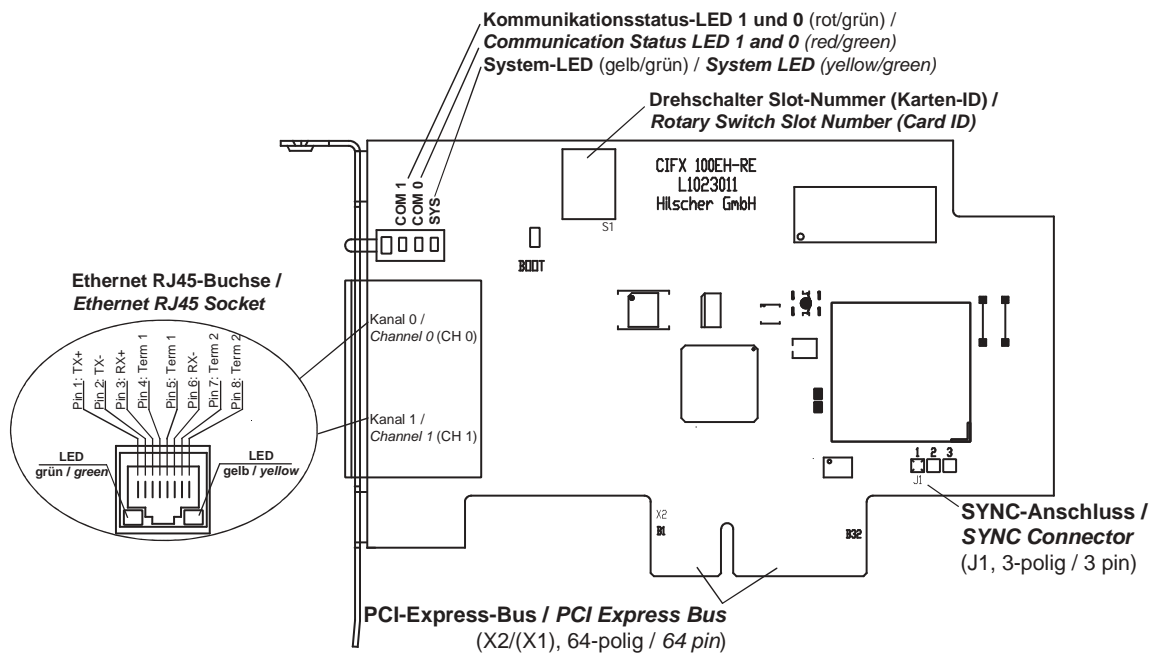
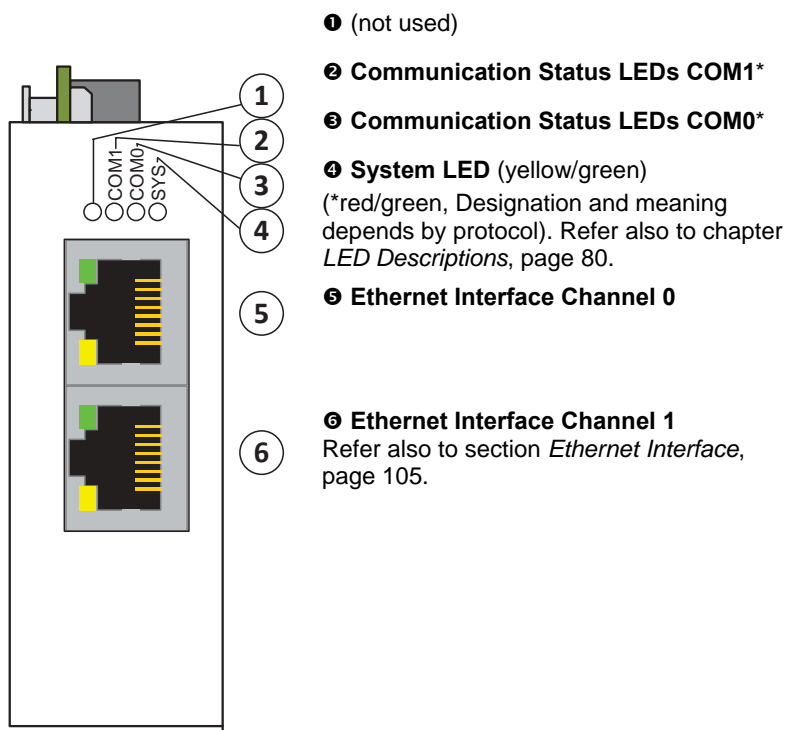

Figure 35: CIFX 100EH-RE\CUBE*

The figure below shows the front plate of the PC card CIFX 100EH-RE\CUBE:



- ❶ (not used)
- ❷ **Communication Status LEDs COM1***
- ❸ **Communication Status LEDs COM0***
- ❹ **System LED (yellow/green)**
(*red/green, Designation and meaning depends by protocol). Refer also to chapter *LED Descriptions*, page 80.
- ❺ **Ethernet Interface Channel 0**
- ❻ **Ethernet Interface Channel 1**
Refer also to section *Ethernet Interface*, page 105.



Note: *Device supports Auto Crossover Function. Note also: With loaded EtherCAT Master firmware only the RJ45 channel 0 can be used, channel 1 is deactivated. Beginning with the EtherCAT Master firmware version 3 channel 1 can be reactivated if redundancy is activated. For Open Modbus/TCP with V2.3.4.0 and higher both RJ45 channels can be used.



About **Rotary Switch for Slot Number (Card ID)** refer to section *Rotary Switch for Slot Number (Card ID)*, on page 110.

For the pin assignment of the **PCI Express** bus X2(X1) see section *Pin Assignment for PCI Express Bus CIFX 100EH-RE\CUBE* on page 115.

For the **SYNC** pin assignment of the SYNC Connector refer to section *Pin Assignment SYNC Connector, J1 (CIFX 100EH)* on page 112.

Figure 36: Front Plate CIFX 100EH-RE\CUBE

5.2.3 CIFX 70E-DP, CIFX 70E-DP\MR

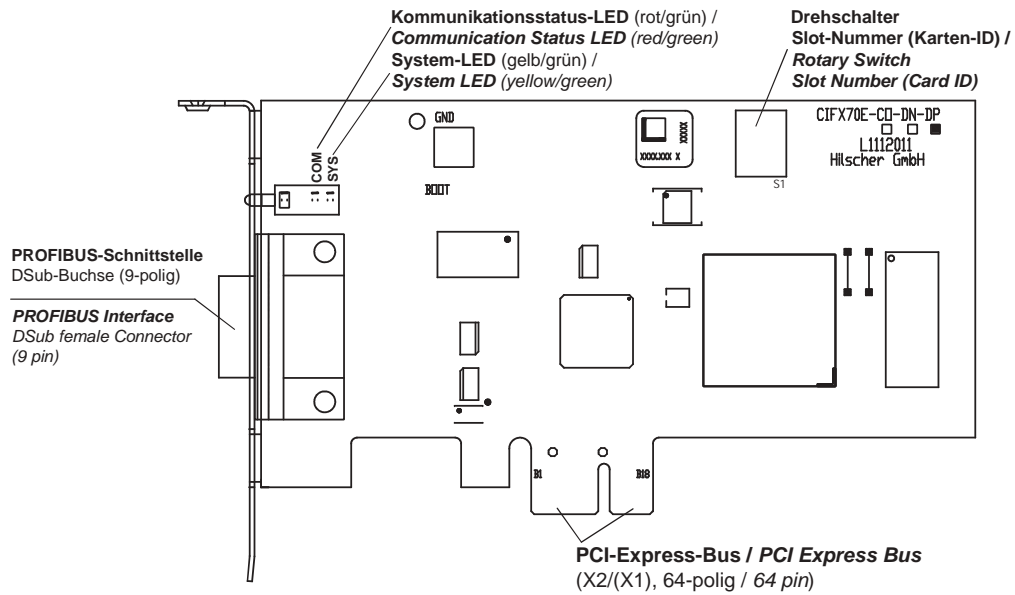

Figure 37: CIFX 70E-DP (Hardware revision 1)

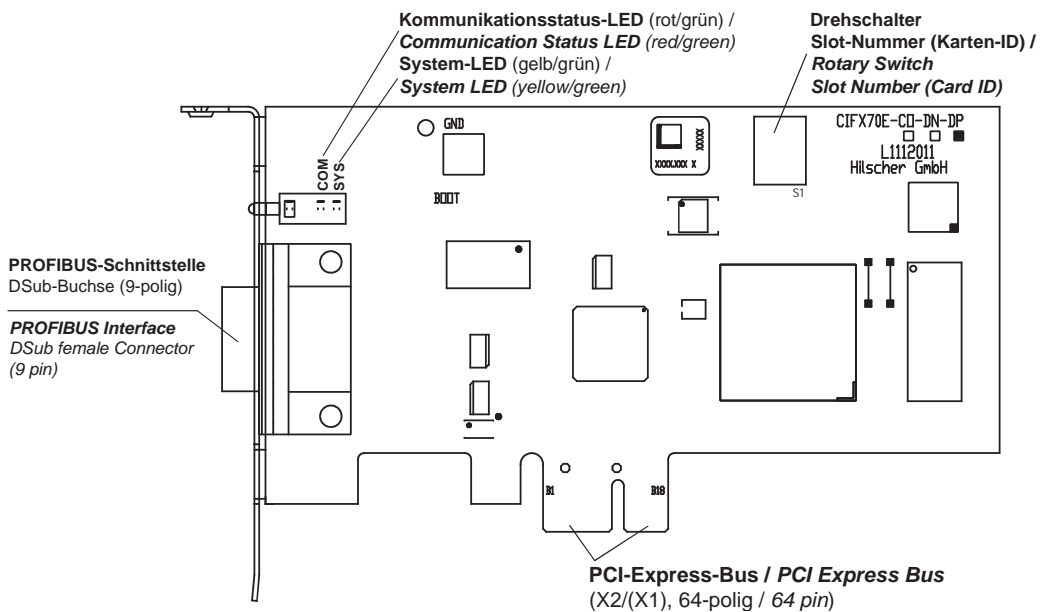

Figure 38: CIFX 70E-DP\MR (Hardware revision 1)



About **Rotary Switch for Slot Number (Card ID)** refer to section *Rotary Switch for Slot Number (Card ID)*, on page 110.

The figure below shows the front plate of the PC card CIFX 70E-DP or CIFX 70E-DPVMR:

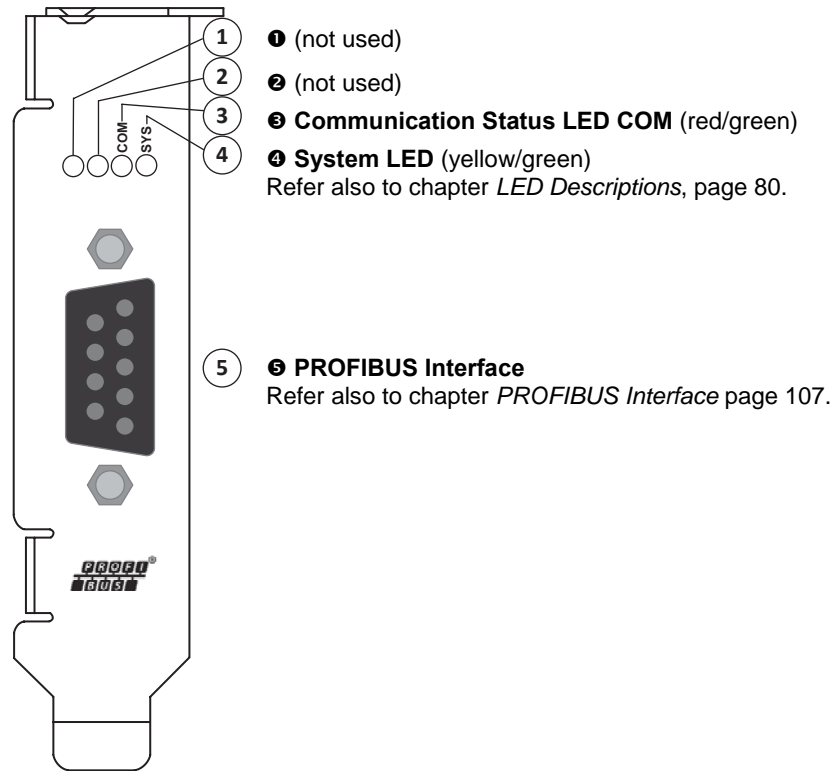

Figure 39: Front Plate CIFX 70E-DP, CIFX 70E-DPVMR

5.2.4 CIFX 70E-CO, CIFX 70E-CO\MR

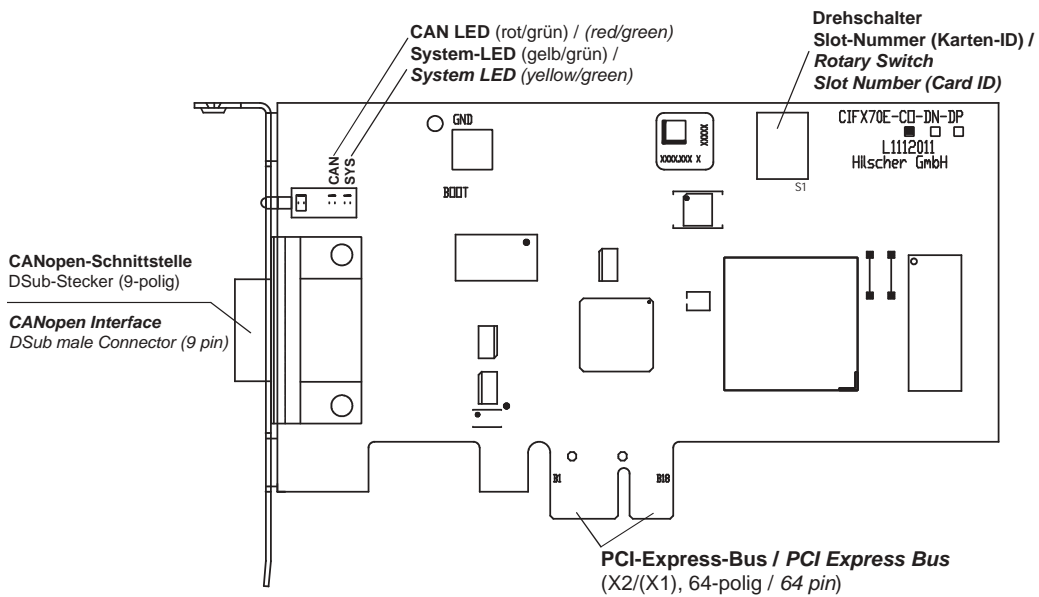

Figure 40: CIFX 70E-CO (Hardware revision 1)

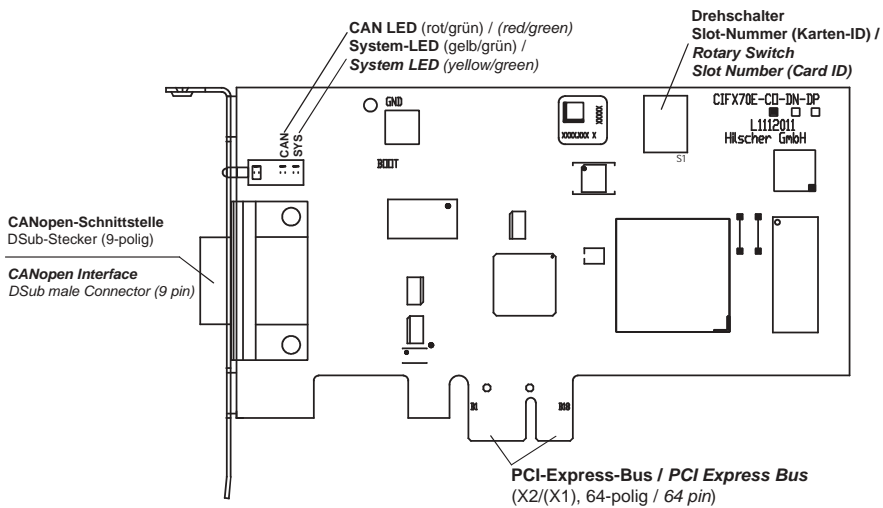

Figure 41: CIFX 70E-CO\MR (Hardware revision 1)



About **Rotary Switch for Slot Number (Card ID)** refer to section *Rotary Switch for Slot Number (Card ID)*, on page 110.

The figure below shows the front plate of the PC card CIFX 70E-CO or CIFX 70E-COMR:

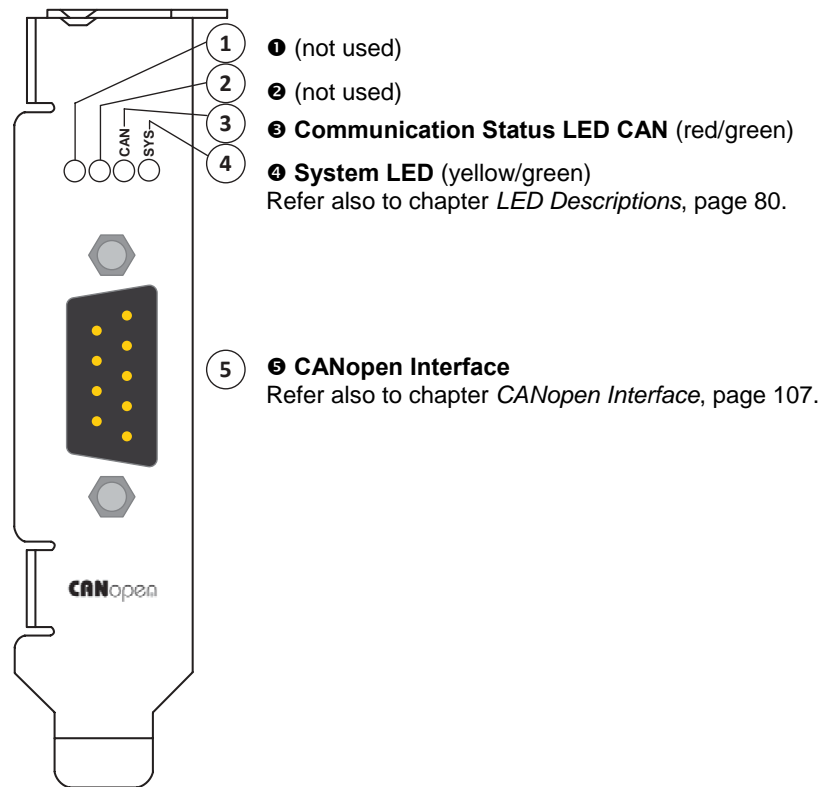

Figure 42: Front Plate CIFX 70E-CO, CIFX 70E-COMR

5.2.5 CIFX 70E-DN, CIFX 70E-DN\MR

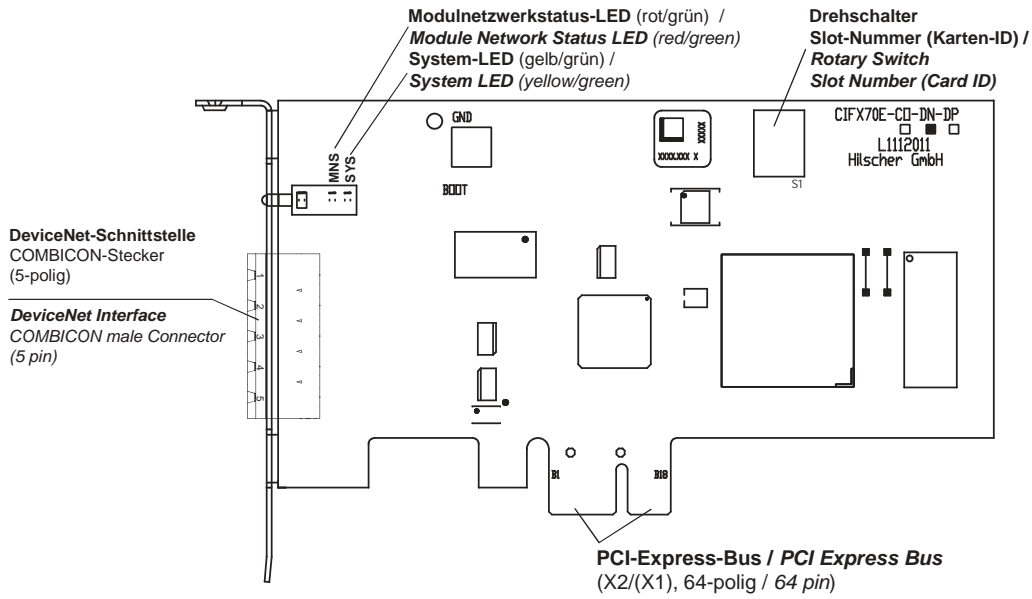

Figure 43: CIFX 70E-DN (Hardware revision 1)

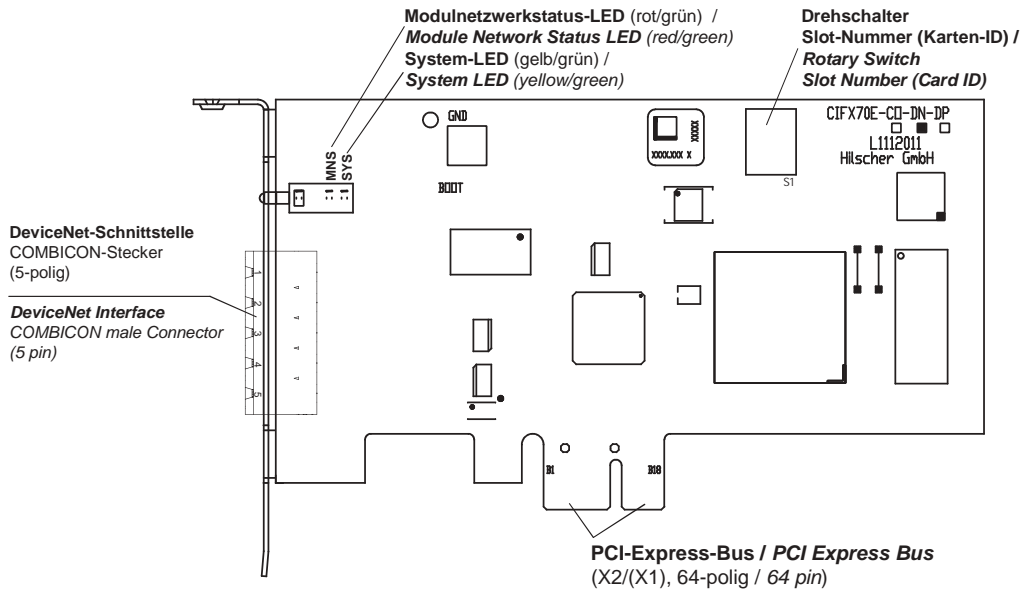

Figure 44: CIFX 70E-DNMR (Hardware revision 1)



About **Rotary Switch for Slot Number (Card ID)** refer to section *Rotary Switch for Slot Number (Card ID)*, on page 110.

The figure below shows the front plate of the PC card CIFX 70E-DN or CIFX 70E-DNMR:

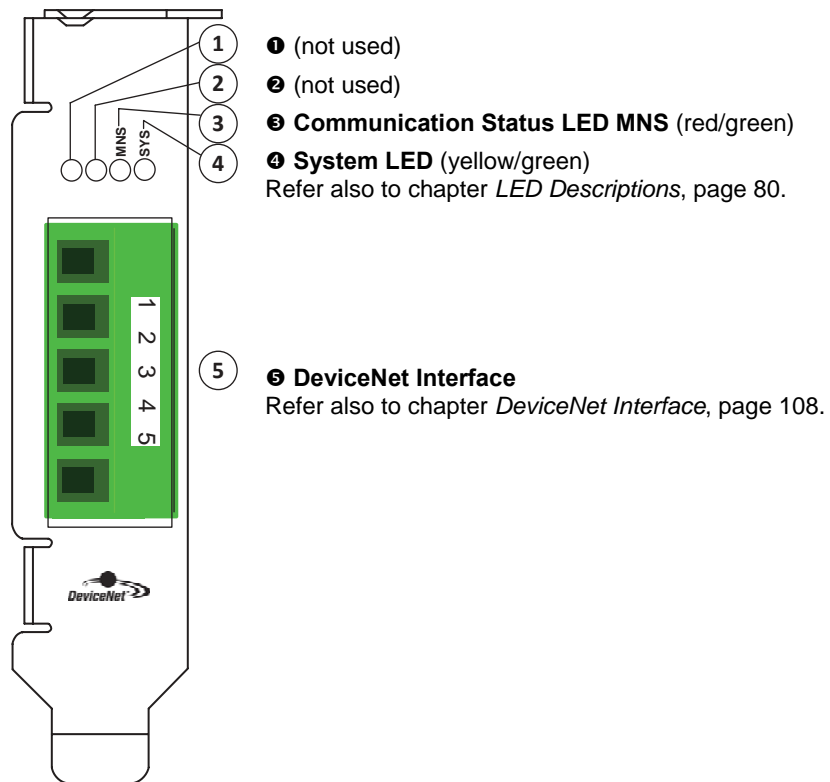

Figure 45: Front Plate CIFX 70E-DN, CIFX 70E-DNMR

6 Hardware Installation and Uninstalling

To install / uninstall the PC Cards cifX **PCI** the PC Cards cifX **PCI Express**

- CIFX 50-RE, CIFX 50-RE\ET,
- CIFX 50-DP, CIFX 50-CO,
- CIFX 50-DN, CIFX 50-CC,
- CIFX 50E-RE, CIFX 50E-RE\ET,
- CIFX 50E-DP, CIFX 50E-CO,
- CIFX 50E-DN, CIFX 50E-CC,
- CIFX 50-2DP,
- CIFX 50-2DP\CO, CIFX 50-2DP\DN,
- CIFX 50-2CO, CIFX 50-2CO\DN,
- CIFX 50-2DN,
- CIFX 50-2ASM,
- CIFX 50E-2ASM

and **Low Profile PCI Express**

- CIFX 70E-RE, CIFX 70E-RE\MR,
- CIFX 100EH-RE\CUBE
- CIFX 70E-DP, CIFX 70E-DP\MR,
- CIFX 70E-CO, CIFX 70E-CO\MR,
- CIFX 70E-DN, CIFX 70E-DN\MR

handle as described in the sections hereafter. The device drawing of your PC card cifX gives information on the manual control elements of your device.



For the installation, uninstalling and replacement of the PC card cifX check any notes in the overview in chapter *Getting Started* on page 37.

6.1 Safety Messages on Personal Injury

Obey to the following safety messages on personal injury, when installing, uninstalling or replacing the PC card cifX.

6.1.1 Electrical Shock Hazard



WARNING

Lethal Electrical Shock caused by parts with more than 50V!



- HAZARDOUS VOLTAGE inside of the PC or of the connecting device.
- Strictly obey to all safety rules provided by the device's manufacturer in the documentation!
- First disconnect the power plug of the PC or of the connecting device, before you open the cabinet.
- Make sure, that the power supply is off at the PC or at the connecting device.
- Open the PC cabinet and install or remove the PC card cifX only after disconnecting power.

6.2 Property Damage Messages

Obey to the following property damage messages, when installing, uninstalling or replacing the PC card cifX.

6.2.1 Device Destruction by exceeding allowed Supply Voltage

Adhere for all PC cards cifX described in this manual the instruction hereafter:

NOTICE**Device Destruction!**

- Use only the permissible supply voltage to operate the PC card cifX.
 - Operating the PC card cifX with a supply voltage above of the specified range leads to device destruction.
-

6.2.2 Device Destruction by exceeding allowed Signaling Voltage

Adhere for all PC cards cifX described in this manual the instruction hereafter:

NOTICE**Device Destruction!**

- All I/O signal pins at the PC card cifX tolerate only the specified signaling voltage!
 - Operation the PC card cifX with a signaling voltage other than the specified signaling voltage may lead to severe damage to the PC card cifX!
-

For detailed information on the supply and signaling voltage of the PC cards cifX described in this manual, refer to section *Power Supply and Host Interface* on page 34.

6.2.3 Electrostatically sensitive Devices

Adhere to the necessary safety precautions for components that are vulnerable with electrostatic discharge.



NOTICE**Electrostatically sensitive Devices**

- To prevent damage to the PC and the PC card cifX, make sure, that the PC card cifX is grounded via the endplate and the PC and make sure, that you are discharged when you install/uninstall the PC card cifX.
-

6.3 Fix Front Plate Sticker

6.3.1 Fix Front Plate Sticker at CIFX 50-RE, CIFX 50-RE\ET, CIFX 50E-RE and CIFX 50E-RE\ET



Note: Your PC card cifX set contains a set of front plate stickers (9 different stickers). Depending from the loaded firmware the label on each sticker indicates for the respective system the following **LED names**:

- of the **system and communication status LEDs** (*above*)
- of the **RJ45 Ethernet female connector LEDs** (*below*).

Further information to this question you find also in chapter *LED Descriptions* beginning from page 80.

NOTICE

Electrostatically sensitive Devices

- To prevent damage to the PC and the PC card cifX, make sure, that the PC card cifX is grounded via the endplate and the PC and make sure, that you are discharged when you install/uninstall the PC card cifX.
- Use the sticker according to the device and firmware and glue it on the front of the PC card CIFX 50-RE, CIFX 50-RE\ET, CIFX 50E-RE or CIFX 50E-RE\ET.

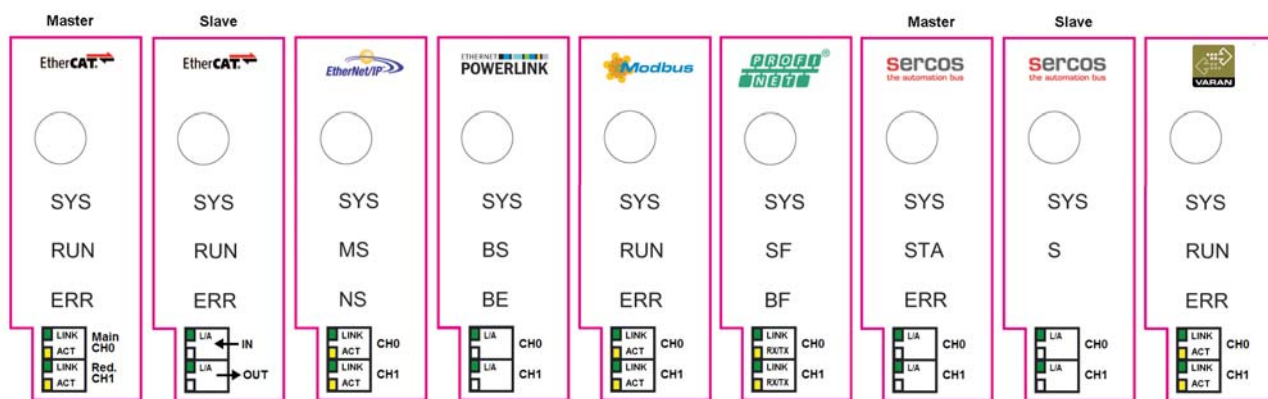

Figure 46: Front Plate Stickers for CIFX 50-RE, CIFX 50-RE\ET, CIFX 50E-RE or CIFX 50E-RE\ET

LED		EtherCAT Master	EtherCAT Slave	EtherNet/IP	Open Modbus/TCP	POWERLINK	PROFINET IO	sercos Master	sercos Slave	VARAN
SYS (yellow/green)		SYS	SYS	SYS	SYS	SYS	SYS	SYS	SYS	SYS
COM 0 (red/ green)		RUN	RUN	MS	RUN	BS	SF	STA	S	RUN
COM 1 (red/ green)		ERR	ERR	NS	ERR	BE	BF	ERR	-	ERR
RJ45 Ch0	green	LINK	L/A IN	LINK	LINK	L/A	LINK	L/A	L/A	LINK
	yellow	ACT	-	ACT	ACT	-	RX/TX	-	-	ACT
RJ45 Ch1	green	LINK	L/A OUT	LINK	LINK	L/A	LINK	L/A	L/A	LINK
	yellow	ACT	-	ACT	ACT	-	RX/TX	-	-	ACT

Table 28: LED Labeling depending of the loaded Firmware

6.3.2 Fix Front Plate Sticker at CIFX 70E-RE, CIFX 70E-RE\MR, CIFX 100EH-RE\CUBE



Note: Your PC card CIFX 70E-RE, CIFX 70E-RE\MR or CIFX 100EH-RE\CUBE set contains a set of front plate stickers (9 different stickers, each 2 parts). Depending from the loaded firmware the label on each sticker indicates for the respective system the following **LED names**:

(1) of the **system and communication status LEDs** (*partial sticker above*)

(2) of the **RJ45 Ethernet female connector LEDs** (*partial sticker below*).

Further information to this question you find also in chapter *LED Descriptions* beginning from page 80.

NOTICE

Electrostatically sensitive Devices

- To prevent damage to the PC and the PC card cifX, make sure, that the PC card cifX is grounded via the endplate and the PC and make sure, that you are discharged when you install/uninstall the PC card cifX.
- Use the two part sticker according to the device and firmware and glue it on the front of the PC card CIFX 70E-RE, CIFX 70E-RE\MR or CIFX 100EH-RE\CUBE.

Front CIFX 100EH-RE\CUBE	Front CIFX 70E-RE, CIFX 70E-REMR	How to
<p>Diagram showing the front plate of the CIFX 100EH-RE\CUBE. A red box labeled 1 is positioned above four LEDs (COM1, COM0, and SYS). A second red box labeled 2 is positioned below two RJ45 Ethernet female connectors.</p>	<p>Diagram showing the front plate of the CIFX 70E-RE, CIFX 70E-REMR. A red box labeled 1 is positioned above four LEDs. A second red box labeled 2 is positioned below two RJ45 Ethernet female connectors.</p>	<p>1. Glue the "partial sticker above" with the system specific names of the system and communication status LEDs above ① of the LEDs COM1, COM0 and SYS on the front plate.</p> <p>2. Glue the "partial sticker below " with the system specific names of the RJ45 Ethernet female connector LEDs below ② of the RJ45 on the front plate.</p>

Table 29: Fix Front Plate Sticker at the CIFX 70E-RE, CIFX 70E-REMR or CIFX 100EH-RE\CUBE

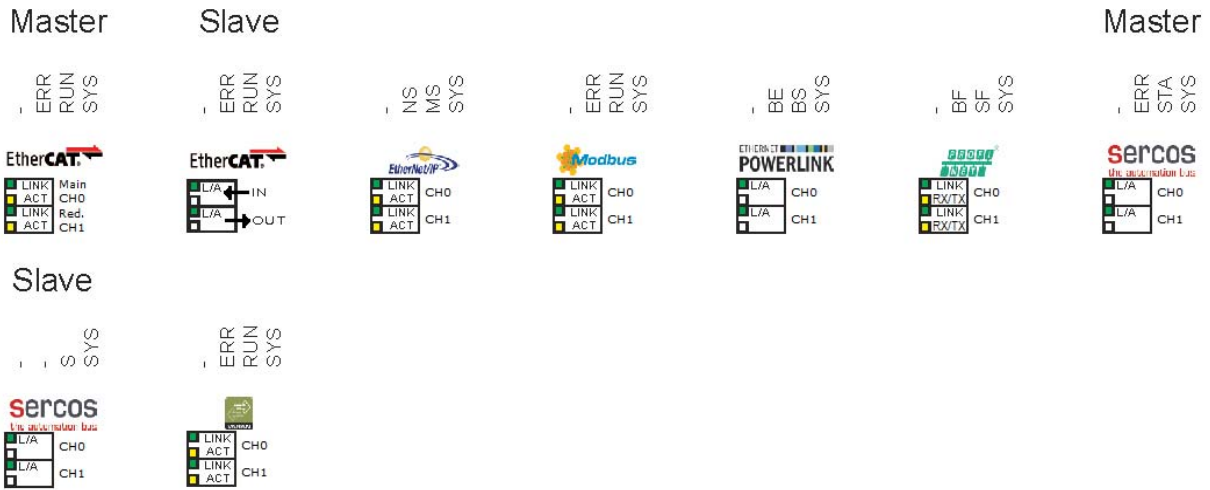

Figure 47: Front Plate Stickers for CIFX 70E-RE, CIFX 70E-REMR

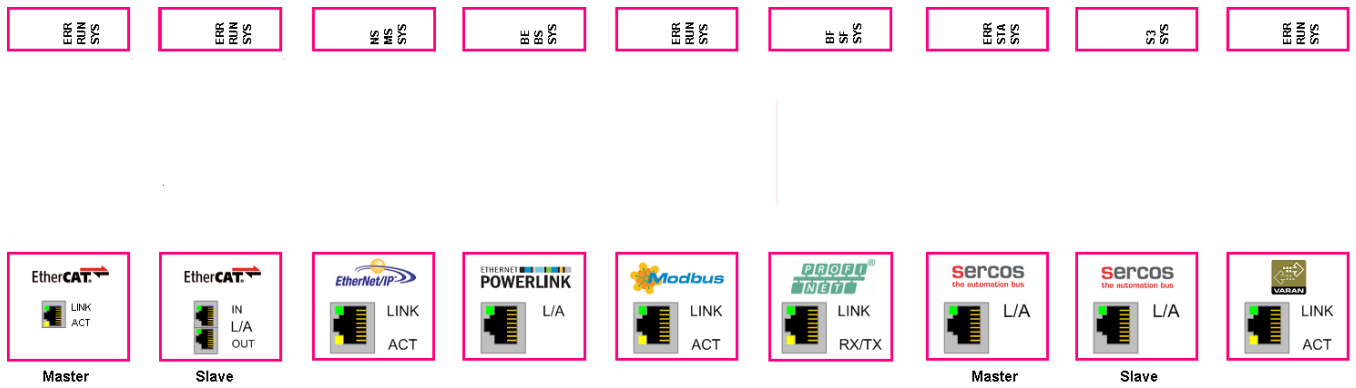

Figure 48: Front Plate Stickers for CIFX 100EH-RE\CUBE

LED		EtherCAT Master	EtherCAT Slave	EtherNet/IP	Open Modbus/TCP	POWERLINK	PROFINET IO	sercos Master	sercos Slave	VARAN
SYS (yellow/green)		SYS	SYS	SYS	SYS	SYS	SYS	SYS	SYS	SYS
COM 0 (red/ green)		RUN	RUN	MS	RUN	BS	SF	STA	S	RUN
COM 1 (red/ green)		ERR	ERR	NS	ERR	BE	BF	ERR	-	ERR
RJ45 Ch0	green	LINK	L/A IN	LINK	LINK	L/A	LINK	L/A	L/A	LINK
	yellow	ACT	-	ACT	ACT	-	RX/TX	-	-	ACT
RJ45 Ch1	green	LINK	L/A OUT	LINK	LINK	L/A	LINK	L/A	L/A	LINK
	yellow	ACT	-	ACT	ACT	-	RX/TX	-	-	ACT

Table 30: LED Labeling depending of the loaded Firmware

6.4 Installing PC Card cifX PCI, PCIe, Low Profile PCIe

1. Adhere to the necessary safety precautions for components that are vulnerable with electrostatic discharge.

NOTICE

Electrostatically sensitive Devices

- To prevent damage to the PC and the PC card cifX, make sure, that the PC card cifX is grounded via the endplate and the PC and make sure, that you are discharged when you install/uninstall the PC card cifX.
2. Fix front plate sticker (only for CIFX 50-RE, CIFX 50-RE\ET, CIFX 50E-RE, CIFX 50E-RE\ET, CIFX 70E-RE, CIFX 70E-RE\MR or CIFX 100EH-RE\CUBE).
 - Use the sticker according to the device and firmware and glue it on the front of the PC card cifX (see section *Fix Front Plate Sticker* on page 74).
 3. Set Slot Number (Card ID).
 - For devices with **Rotary Switch Slot Number (Card ID)** set the **Slot Number (Card ID)**: (Value 0 or a value from 1 to 9), (see section *Rotary Switch for Slot Number (Card ID)* on page 110).
 4. Take safety precautions.

WARNING

Lethal Electrical Shock caused by parts with more than 50V!

- Disconnect the power plug of the PC or of the connecting device.
- Make sure, that the power supply is off at the PC or at the connecting device.

NOTICE

Device Destruction!

- The PC card CIFX 100EH-RE\CUBE may not be installed in standard PCs. The pin assignment of the PCI Express bus does not meet the standard [bus spec 3]. By consequence malfunction can occur at the PCI express bus.
 - Install the PC card CIFX 100EH-RE\CUBE exclusively in KEBA KeControl industry PCs series CP 3XX (Cube).
5. Open cabinet.
 - Open the cabinet of the PC or of the connecting device.
 6. Install PC card cifX.
 - Plug the PC card cifX **PCI** into a free PCI slot.
 - Plug the PC card cifX **PCI Express** or **Low Profile PCI Express** into a free PCI express slot.
 - Fix the PC card cifX using the hole intended.

After this:

7. Close cabinet.
 - Close the cabinet of the PC or connecting device.

8. Plug the connecting cable to the Master or Slave.
 - Note for the PC card CIFX 70E-RE, CIFX 70E-RE\MR or CIFX 100EH-RE\CUBE:



Note: The RJ45 socket is only for use in LAN, not for telecommunication circuits. For further information refer to section *Ethernet Interface* on page 105.

- Plug the connecting cable from the PC card cifX to the PC card Master or Slave.
9. Connect the PC or the connecting device to the power supply and switch it on.
 - Connect the PC or the connecting device to the power supply.
 - Switch on the PC or the connecting device.

6.5 Uninstalling the PC Card cifX PCI, PCIe, Low Profile PCIe

1. Take safety precautions.

WARNING

Lethal Electrical Shock caused by parts with more than 50V!

- Disconnect the power plug of the PC or of the connecting device.
- Make sure, that the power supply is off at the PC or at the connecting device.

NOTICE

Electrostatically sensitive Devices

- To prevent damage to the PC and the PC card cifX, make sure, that the PC card cifX is grounded via the endplate and the PC and make sure, that you are discharged when you install/uninstall the PC card cifX.
2. Remove the connecting cable to the Master or Slave.
 - Remove the connecting cable between the PC card cifX to be replaced and the PC card Master or Slave.
 3. Open cabinet.
 - Open the cabinet of the PC or of the connecting device.
 4. Uninstall PC card cifX.
 - Loosen the PC card cifX.
 - Remove the PC card cifX from the **PCI** slot or from the **PCI express** slot.

After this:

5. Close cabinet.
 - Close the cabinet of the PC or connecting device.

7 Troubleshooting

7.1 Instructions for Problem Solving

In case of any error, follow the instructions for problem solving given here:

General

- Check the PC card cifX operating requirements according to the requirements given in section *Requirements for Operation* on page 35.

SYS and COM Status LEDs

Troubleshooting of the system is done by examining the LEDs behaviour. The PC cards cifX have depending by card type two or three bicolor status LEDs, which inform the user about the communication state of the device.

- The **SYS** LED shows the common system status of the device. It can be yellow or green ON or it can blink green/yellow.
- The **COM** LEDs display the status of the Real-Time Ethernet or fieldbus communication. Depending by protocol and state, the LEDs can be ON or flash cyclic or acyclic in green or red (or orange).

If the LED SYS is solid green and the LED COM or COM0 is static green, the PC card cifX is in operational state, the Master is in data exchange with the connected Slaves and the communication is running without fault. The meaning of the LEDs is described in chapter *LED Descriptions* beginning from page 80.

LINK-LED (for PC cards cifX Real-Time Ethernet)

- Check using the LINK LED's status whether a connection to the Ethernet is established. Therefore use the description on the LINK LED in the chapter *LED Descriptions* beginning from page 80.

Cable

- Check that the pin assignment of the cable is correct. This means, the cable by which you connect the PC card cifX to the PC card Master or Slave.

Configuration

- Check the configuration in the Master device and the Slave device. The configuration has to match.

Diagnosis

Via **Online > Diagnosis** (for SYCON.net) or **netX Configuration Tool > Diagnostics** (for netX Configuration Tool) the diagnostic information of the device is shown. The shown diagnostic information depends on the used protocol.



Further information about the device diagnosis and its functions you find in the operating instruction manual of the corresponding Real-Time Ethernet or fieldbus system.

8 LED Descriptions

The LEDs will be used to indicate status information of the PC card cifX. Each LED has a specific function during Run, configuration download and error indications. The descriptions hereafter show the reaction of each LED for the PC card cifX during these states.

8.1 Overview LEDs Real-Time Ethernet Systems



Note: The meaning of the communication status LEDs and of the Ethernet LEDs at the device is defined by the loaded firmware of the protocol.

LED Naming in the Device Drawing		EtherCAT Master	EtherCAT Slave	EtherNet/IP	Open-Modbus/TCP	POWERLINK	PROFINET IO	sercos Master	sercos Slave	VARAN
SYS (System Status) ● (yellow) ● (green) (yellow/green)		SYS	SYS	SYS	SYS	SYS	SYS	SYS	SYS	SYS
COM 0 (Communication Status)		RUN ● (green)	RUN ● (green)	MS ● (red) ● (green) (red/green)	RUN ● (green)	BS ● (green)	SF ● (red) (red)	STA ● (green)	S ● (red) ● (green) ● (orange) (red/green / orange)	RUN ● (green)
COM 1 (Communication Status)		ERR ● (red)	ERR ● (red)	NS ● (red) ● (green) (red/green)	ERR ● (red)	BE ● (red)	BF ● (red)	ERR ● (red)	-	ERR ● (red)
Ethernet Ch0	● (green)	LINK	L/A IN	LINK	LINK	L/A	LINK	L/A	L/A	LINK
	● (yellow)	ACT	-	ACT	ACT	-	RX/TX	-	-	ACT
Ethernet Ch1	● (green)	-	L/A OUT	LINK	LINK	L/A	LINK	L/A	L/A	LINK
	● (yellow)	-	-	ACT	ACT	-	RX/TX	-	-	ACT

Table 31: Overview LEDs Real-Time Ethernet Systems

LED	Name	Meaning
System Status	SYS	System Status
Communication Status	COM	Communication Status
	RUN	Run
	ERR	Error
	STA	Status
	MS	Module Status
	NS	Network Status
	BS	Bus Status
	BE	Bus Error
	SF	System Failure
	BF	Bus Failure
	S	Status / Error

Table 32: LED Names

LED	Name	Meaning
Ethernet	LINK, L	Link
	ACT, A	Activity
	L/A	Link/Activity
	L/A IN	Link/Activity Input
	L/A OUT	Link/Activity Output
	RX/TX	Receive/Transmit

8.2 Overview LEDs Fieldbus Systems







LED	PROFIBUS DP or PROFIBUS MPI (1 Duo-LED)	CANopen (1 Duo LED)	DeviceNet (1 Duo LED)	CC-Link (Slave) (2 LEDs)
System Status  (yellow/green)	SYS	SYS	SYS	SYS
Communication Status	COM  (red/green)	CAN  (red/green)	MNS  (red/green)	L RUN  (green) L ERR  (red)

Table 33: Overview LEDs by Fieldbus System for 1 Channel Devices



LED	PROFIBUS D (1 Duo LED/ channel)	CANopen (1 Duo LED/ channel)	DeviceNet (1 Duo LED/ channel)	AS-Interface (Master) (1 Duo LED/ channel)
System Status  (yellow/green)	SYS	SYS	SYS	SYS
Communication Status  (red/green)	COM0	CAN0	MNS0	COM1
Channel X1 (SYCONnet: Ch0)	COM1	CAN1	MNS1	COM2
Channel X2 (SYCONnet: Ch1)				

Table 34: Overview LEDs by Fieldbus System for 2 Channel Devices

LED	Name	Meaning
System Status	SYS	System Status
Communication Status	COM	Communication Status
	CAN	CANopen Status
	MNS	Module Network Status
	L RUN / L ERR	Status Run / Status Error

Table 35: LED Names



* Descriptions for 2-Communication Status LEDs of PROFIBUS DP Master and Slave devices as well as of CANopen Master and Slave devices of earlier device revisions are included in the user manual for PC cards cifX fieldbus up to manual rev. 23.

8.3 System LED

The System Status LED **SYS** can assume the states described below.





LED	Color	State	Meaning
SYS	Duo LED yellow/green		
	 (green)	On	Operating System running
	 (green/yellow)	Blinking	Second stage bootloader is waiting for firmware.
	 (yellow)	On	Bootloader netX (= romloader) is waiting for second stage bootloader.
	 (off)	Off	Power supply for the device is missing or hardware defect.

Table 36: System Status LED States

LED State	Definition
On	The indicator is constantly on.
Off	The indicator is constantly off.
Blinking	The indicator turns on and off cyclically.

Table 37: System Status LED State Definitions

8.4 EtherCAT Master

For the EtherCAT Master protocol, the communication LEDs **RUN** and **ERR** as well as the Ethernet LEDs **LINK** and **ACT** can assume the states described below. This description is valid from stack version V3.0.











LED	Color	State	Meaning
RUN General name: COM 0	Duo LED red/green		
	 (off)	Off	INIT: The device is in state INIT.
	 (green)	Blinking (2,5 Hz)	PRE-OPERATIONAL: The device is in PRE-OPERATIONAL state.
	 (green)	Flickering (10 Hz)	BOOT: Device is in Boot mode.
	 (green)	Single flash	SAFE-OPERATIONAL: The device is in SAFE-OPERATIONAL state.
	 (green)	On	OPERATIONAL: The device is in OPERATIONAL state.
ERR General name: COM 1	Duo-LED red/green		
	 (off)	Off	Master has no errors.
	 (red)	On	Master has detected a communication error. The error is indicated in the DPM.
LINK Ch0	LED green		
	 (green)	On	The device is linked to the Ethernet.
	 (off)	Off	The device has no link to the Ethernet.
ACT Ch0	LED yellow		
	 (yellow)	Flickering (load dependant)	The device sends/receives Ethernet frames.
	 (off)	Off	The device does not send/receive Ethernet frames.

Table 38: LED states for the EtherCAT Master protocol

LED State	Definition
On	The indicator is constantly on.
Off	The indicator is constantly off.
Blinking (2,5 Hz)	The indicator turns on and off with a frequency of 2,5 Hz: "on" for 200 ms, followed by "off" for 200 ms.
Flickering (10 Hz)	The indicator turns on and off with a frequency of 10 Hz: "on" for 50 ms, followed by "off" for 50 ms.
Single flash	The indicator shows one short flash (200 ms) followed by a long "off" phase (1,000 ms).
Flickering (load dependant)	The indicator turns on and off with a frequency of approximately 10 Hz to indicate high Ethernet activity: on for approximately 50 ms, followed by off for 50 ms. The indicator turns on and off in irregular intervals to indicate low Ethernet activity.

Table 39: LED state definitions for the EtherCAT Master protocol

8.5 EtherCAT Slave

For the EtherCAT Slave protocol, the communication LEDs **RUN** and **ERR** as well as the Ethernet-LED **L/A IN** or **L/A OUT** can assume the states described below. This description is valid from stack version V2.5 (V2).













LED	Color	State	Meaning
RUN General name: COM 0	Duo LED red/green		
	 (off)	Off	INIT: The device is in state INIT.
	 (green)	Blinking (2,5 Hz)	PRE-OPERATIONAL: The device is in PRE-OPERATIONAL state.
	 (green)	Single flash	SAFE-OPERATIONAL: The device is in SAFE-OPERATIONAL state.
	 (green)	On	OPERATIONAL: The device is in OPERATIONAL state.
ERR General name: COM 1	Duo-LED red/green		
	 (off)	Off	No error: The EtherCAT communication of the device is in working condition.
	 (red)	Blinking (2,5 Hz)	Invalid configuration: General Configuration Error Possible reason: State change commanded by master is impossible due to register or object settings.
	 (red)	Single Flash	Local error: Slave device application has changed the EtherCAT state autonomously. Possible reason 1: A host watchdog timeout has occurred. Possible reason 2: Synchronization Error, device enters Safe-Operational automatically.
	 (red)	Double Flash	Application watchdog timeout: An application watchdog timeout has occurred. Possible reason: Sync Manager Watchdog timeout.
L/A IN or L/A OUT	LED green		
	 (green)	On	Link: The device is linked to the Ethernet, but does not send/receive Ethernet frames.
	 (green)	Flickering (load dependant)	Activity: The device is linked to the Ethernet and sends/receives Ethernet frames.
	 (off)	Off	The device has no link to the Ethernet.
	LED yellow		
	 (off)	Off	This LED is not used.

Table 40: LED states for the EtherCAT Slave protocol

LED State	Beschreibung
On	The indicator is constantly on.
Off	The indicator is constantly off.
Blinking (2,5 Hz)	The indicator turns on and off with a frequency of 2,5 Hz: "on" for 200 ms, followed by "off" for 200 ms.
Single flash	The indicator shows one short flash (200 ms) followed by a long "off" phase (1,000 ms).
Double flash	The indicator shows a sequence of two short flashes (each 200 ms), separated by a short off phase (200 ms). The sequence is finished by a long off phase (1,000 ms).
Flickering (load dependant)	The indicator turns on and off with a frequency of approximately 10 Hz to indicate high Ethernet activity: on for approximately 50 ms, followed by off for 50 ms. The indicator turns on and off in irregular intervals to indicate low Ethernet activity.

Table 41: LED state definitions for the EtherCAT Slave protocol

8.6 EtherNet/IP Scanner (Master)

For the EtherNet/IP Scanner protocol, the communication LEDs **MS** and **NS** as well as the Ethernet LEDs **LINK** and **ACT** can assume the states described below. This description is valid from stack version V2.6.















LED	Color	State	Meaning
MS (Module status) General name: COM 0	Duo-LED red/green		
	 (green)	On	Device operational: The device is operating correctly.
	 (green)	Flashing (1 Hz)	Standby: The device has not been configured.
	 (red/green)	Flashing (1 Hz)	Self-test: The device is performing its power up testing.
	 (red)	Flashing (1 Hz)	Minor fault: The device has detected a recoverable minor fault. E. g. an incorrect or inconsistent configuration can be considered as a minor fault.
	 (red)	On	Major fault: The device has detected a non-recoverable major fault.
NS (Network-status) General name:: COM 1	Duo-LED red/green		
	 (green)	On	Connected: The device has at least one established connection (even to the Message Router).
	 (green)	Flashing (1 Hz)	No connections: The device has no established connections, but has obtained an IP address.
	 (red/green)	Flashing (1 Hz)	Self-test: The device is performing its power up testing.
	 (red)	Flashing (1 Hz)	Connection timeout: One or more of the connections in which this device is the target have timed out. This status will be finished only if all timed out connections are reestablished or if the device is reset.
	 (red)	On	Duplicate IP: The device has detected that its IP address is already in use.
LINK Ch0 & Ch1	LED green		
	 (green)	On	The device is linked to the Ethernet.
	 (Off)	Off	The device has no link to the Ethernet.
ACT Ch0 & Ch1	LED yellow		
	 (yellow)	Flickering (load dependant)	The device sends/receives Ethernet frames.
	 (Off)	Off	The device does not send/receive Ethernet frames.

Table 42: LED states for the EtherNet/IP Scanner protocol

LED state	Definition
On	The indicator is constantly on.
Off	The indicator is constantly off.
Flashing (1 Hz)	The indicator turns on and off with a frequency of 1 Hz: "on" for 500 ms, followed by "off" for 500 ms.
Flickering (load dependant)	The indicator turns on and off with a frequency of approximately 10 Hz to indicate high Ethernet activity: on for approximately 50 ms, followed by off for 50 ms. The indicator turns on and off in irregular intervals to indicate low Ethernet activity.

Table 43: LED state definitions for the EtherNet/IP Scanner protocol

8.7 EtherNet/IP Adapter (Slave)

For the EtherNet/IP Adapter protocol, the communication LEDs **MS** and **NS** as well as the Ethernet LEDs **LINK** and **ACT** can assume the states described below. This description is valid from stack version V2.7 (V2) or from V3.0.

















LED	Color	State	Meaning
MS (Module status) General name: COM 0	Duo-LED red/green		
	 (green)	On	Device operational: The device is operating correctly.
	 (green)	Flashing (1 Hz)	Standby: The device has not been configured.
	 (red/green)	Flashing (1 Hz)	Self-test: The device is performing its power up testing.
	 (red)	Flashing (1 Hz)	Minor fault: The device has detected a recoverable minor fault. E. g. an incorrect or inconsistent configuration can be considered as a minor fault.
	 (red)	On	Major fault: The device has detected a non-recoverable major fault.
	 (Off)	Off	No power: The power supply to the device is missing.
NS (Network-status) General name: COM 1	Duo-LED red/green		
	 (green)	On	Connected: The device has at least one established connection (even to the Message Router).
	 (green)	Flashing (1 Hz)	No connections: The device has no established connections, but has obtained an IP address.
	 (red/green)	Flashing (1 Hz)	Self-test: The device is performing its power up testing.
	 (red)	Flashing (1 Hz)	Connection timeout: One or more of the connections in which this device is the target have timed out. This status will be finished only if all timed out connections are reestablished or if the device is reset.
	 (red)	On	Duplicate IP: The device has detected that its IP address is already in use.
	 (Off)	Off	Not powered, no IP address: The device does not have an IP address (or is powered off).
LINK Ch0 & Ch1	LED green		
	 (green)	On	The device is linked to the Ethernet.
	 (Off)	Off	The device has no link to the Ethernet.
ACT Ch0 & Ch1	LED yellow		
	 (yellow)	Flickering (load dependant)	The device sends/receives Ethernet frames.
	 (Off)	Off	The device does not send/receive Ethernet frames.

Table 44: LED states for the EtherNet/IP Adapter protocol

LED state	Definition
On	The indicator is constantly on.
Off	The indicator is constantly off.
Flashing (1 Hz)	The indicator turns on and off with a frequency of 1 Hz: "on" for 500 ms, followed by "off" for 500 ms.
Flickering (load dependant)	The indicator turns on and off with a frequency of approximately 10 Hz to indicate high Ethernet activity: on for approximately 50 ms, followed by off for 50 ms. The indicator turns on and off in irregular intervals to indicate low Ethernet activity.

Table 45: LED state definitions for the EtherNet/IP Adapter protocol

8.8 Open Modbus/TCP

For the OpenModbusTCP protocol, the communication LEDs **RUN** and **ERR** as well as the Ethernet LEDs **LINK** and **ACT** can assume the states described below. This description is valid from stack version V2.5.











LED	Color	State	Meaning
RUN General name: COM 0	Duo-LED red/green		
	 (green)	On	Connected: OMB task has communication. At least one TCP connection is established.
	 (green)	Flashing (1 Hz)	Ready, not yet configured: OMB task is ready and not yet configured.
	 (green)	Flashing (5 Hz)	Waiting for Communication: OMB task is configured.
	 (off)	Off	Not Ready: OMB task is not ready.
ERR General name: COM 1	Duo-LED red/green		
	 (off)	Off	No communication error
	 (red)	Flashing (2 Hz, 25% on)	System error
	 (red)	On	Communication error active
LINK Ch0 & Ch1	LED green		
	 (green)	On	The device is linked to the Ethernet.
	 (off)	Off	The device has no link to the Ethernet.
ACT Ch0 & Ch1	LED yellow		
	 (yellow)	Flickering (load dependant)	The device sends/receives Ethernet frames.
	 (off)	Off	The device does not send/receive Ethernet frames.

Table 46: LED states for the OpenModbusTCP protocol

LED state	Definition
On	The indicator is constantly on.
Off	The indicator is constantly off.
Flashing (1 Hz)	The indicator turns on and off with a frequency of 1 Hz: "on" for 500 ms, followed by "off" for 500 ms.
Flashing (2 Hz, 25% on)	The indicator turns on and off with a frequency of 2 Hz: "on" for 125 ms, followed by "off" for 375 ms.
Flashing (5 Hz)	The indicator turns on and off with a frequency of 5 Hz: "on" for 100 ms, followed by "off" for 100 ms.
Flickering (load dependant)	The indicator turns on and off with a frequency of approximately 10 Hz to indicate high Ethernet activity: on for approximately 50 ms, followed by off for 50 ms. The indicator turns on and off in irregular intervals to indicate low Ethernet activity.

Table 47: LED state definitions for the OpenModbusTCP protocol

8.9 POWERLINK Controlled Node/Slave

For the POWERLINK Controlled Node protocol, the communication LEDs **BS** (Bus Status) and **BE** (Bus Error) as well as the Ethernet LED **L/A** can assume the states described below. This description is valid from stack version V2.1.













LED	Color	State	Meaning
BS (Bus Status) General name: COM 0	Duo LED red/green		
	 (green)	On	Slave is in ' Operational ' state
	 (green)	Triple Flash	Slave is in ' ReadyToOperate ' state
	 (green)	Double flash	Slave is in ' Pre-Operational 2 ' state
	 (green)	Single flash	Slave is in ' Pre-Operational 1 ' state
	 (red/green)	Flickering (10 Hz)	Slave is in ' Basic Ethernet ' state
	 (red/green)	Blinking (2,5 Hz)	Slave is in ' Stopped ' state
	 (off)	Off	Slave initializing
BE (Bus Error) General name: COM 1	Duo LED red/green		
	 (off)	Off	Slave has no error
	 (red)	On	Slave has detected an error
L/A Ch0 & Ch1	LED green		
	 (green)	On	Link: The device is linked to the Ethernet, but does not send/receive Ethernet frames.
	 (green)	Flickering (load dependant)	Activity: The device is linked to the Ethernet and sends/receives Ethernet frames.
	 (off)	Off	The device has no link to the Ethernet.
Ch0 & Ch1	LED yellow		
	 (off)	Off	This LED is not used.

Table 48: LED states for the POWERLINK Controlled Node protocol

LED state	Definition
On	The indicator is constantly on.
Off	The indicator is constantly off.
Triple Flash	The indicator shows a sequence of three short flashes (each 200 ms), separated by a short off phase (200 ms). The sequence is finished by a long off phase (1,000 ms).
Double flash	The indicator shows a sequence of two short flashes (each 200 ms), separated by a short off phase (200 ms). The sequence is finished by a long off phase (1,000 ms).
Single flash	The indicator shows one short flash (200 ms) followed by a long "off" phase (1,000 ms).
Flickering (10 Hz)	The indicator turns on and off with a frequency of approximately 10 Hz: on for approximately 50 ms, followed by off for 50 ms. Red and green LEDs shall be on alternately.
Blinking (2,5 Hz)	The indicator turns on and off with a frequency of approximately 2.5 Hz: on for approximately 200 ms, followed by off for 200 ms. Red and green LEDs shall be on alternately.
Flickering (load dependant)	The indicator turns on and off with a frequency of approximately 10 Hz to indicate high Ethernet activity: on for approximately 50 ms, followed by off for 50 ms. The indicator turns on and off in irregular intervals to indicate low Ethernet activity.

Table 49: LED state definitions for the POWERLINK Controlled Node protocol

8.10 PROFINET IO-Controller

For the PROFINET IO-Controller protocol, the communication LEDs **SF** (system failure) and **BF** (bus failure) as well as the Ethernet LEDs **LINK** and **RX/TX** can assume the states described below. This description is valid from stack version V2.6.













LED	Color	State	Meaning
SF (System Failure) General name: COM 0	Duo LED red/green		
	 (off)	Off	No error
	 (red)	Flashing (1 Hz, 3 s)	DCP signal service is initiated via the bus.
	 (red)	Flashing (2 Hz)	System error: Invalid configuration, Watchdog error or internal error
	 (red)	On (together with SF „red ON)	System error: Invalid configuration, Watchdog error or internal error
BF (Bus Failure) General name: COM 1	Duo LED red/green		
	 (off)	Off	No error
	 (red)	Flashing (2 Hz)	Configuration fault: Not all configured IO-Devices are connected.
	 (red)	On (together with SF „red ON“)	No valid Master license
	 (red)	On (together with SF „red OFF“)	No Connection: No Link.
LINK Ch0 & Ch1	LED green		
	 (green)	On	The device is linked to the Ethernet.
	 (off)	Off	The device has no link to the Ethernet.
RX/TX Ch0 & Ch1	LED yellow		
	 (gelb)	Flickering (load dependant)	The device sends/receives Ethernet frames.
	 (off)	Off	The device does not send/receive Ethernet frames.

Table 50: LED states for the PROFINET IO-Controller protocol

LED state	Definition
On	The indicator is constantly on.
Off	The indicator is constantly off.
Flashing (1 Hz, 3 s)	The indicator turns on and off for 3 seconds with a frequency of 1 Hz: “on” for 500 ms, followed by “off” for 500 ms.
Flashing (2 Hz)	The indicator turns on and off with a frequency of 2 Hz: “on” for 250 ms, followed by “off” for 250 ms.
Flickering (load dependant)	The indicator turns on and off with a frequency of approximately 10 Hz to indicate high Ethernet activity: on for approximately 50 ms, followed by off for 50 ms. The indicator turns on and off in irregular intervals to indicate low Ethernet activity.

Table 51: LED state definitions for the PROFINET IO-Controller protocol

8.11 PROFINET IO-Device

For the PROFINET IO-Device protocol, the communication LEDs **SF** (System Failure) and **BF** (Bus Failure) as well as the Ethernet LEDs **LINK** and **RX/TX** can assume the states described below. This description is valid from stack version V3.x (V3).











LED	Color	State	Meaning
SF (System Failure) General name: COM 0	Duo LED red/green		
	 (off)	Off	No error
	 (red)	Flashing (1 Hz, 3 s)	DCP signal service is initiated via the bus.
	 (red)	On	Watchdog timeout; channel, generic or extended diagnosis present; system error
BF (Bus Failure) General name: COM 1	Duo LED red/green		
	 (off)	Off	No error
	 (red)	Flashing (2 Hz)	No data exchange
	 (red)	On	No configuration; or low speed physical link; or no physical link
LINK Ch0 & Ch1	LED green		
	 (green)	On	The device is linked to the Ethernet.
	 (off)	Off	The device has no link to the Ethernet.
RX/TX Ch0 & Ch1	LED yellow		
	 (gelb)	Flickering (load dependant)	The device sends/receives Ethernet frames.
	 (off)	Off	The device does not send/receive Ethernet frames.

Table 52: LED states for the PROFINET IO-Device protocol

LED state	Definition
On	The indicator is constantly on.
Off	The indicator is constantly off.
Flashing (1 Hz, 3 s)	The indicator turns on and off for 3 seconds with a frequency of 1 Hz: "on" for 500 ms, followed by "off" for 500 ms.
Flashing (2 Hz)	The indicator turns on and off with a frequency of 2 Hz: "on" for 250 ms, followed by "off" for 250 ms.
Flickering (load dependant)	The indicator turns on and off with a frequency of approximately 10 Hz to indicate high Ethernet activity: on for approximately 50 ms, followed by off for 50 ms. The indicator turns on and off in irregular intervals to indicate low Ethernet activity.

Table 53: LED state definitions for the PROFINET IO-Device protocol

8.12 sercos Master

For the sercos Master protocol, the communication LEDs **STA** and **ERR** as well as the Ethernet LED **L/A** can assume the states described below. This description is valid from stack version V2.1.





















LED	Color	State	Meaning
STA General name: COM 0	Duo LED red/green		
	 (green)	On	CP4: Communication phase 4
	 (green)	Triple Flash	CP3: Communication phase 3
	 (green)	Double flash	CP2: Communication phase 2
	 (green)	Single flash	CP1: Communication phase 1
	 (green)	Blinking (2,5 Hz)	CP0: Communication phase 0
	 (green)	Flickering (10 Hz)	Master is not configured and is in NRT. After a status change this isn't indicated again
	 (off)	Off	NRT: Non Real-Time Mode
ERR General name: COM 1	Duo LED red/green		
	 (red)	Single flash	Bus Sync error threshold
	 (red)	Double flash	Internal Stop of the bus cycle
	 (red)	Triple Flash	DPM watchdog has expired.
	 (red)	Quadruple Flash	No Master license present in the device.
	 (red)	Blinking (2,5 Hz)	Error in the configuration database.
	 (red)	Single Flickering	Channel Init was executed at the Master.
	 (red)	Double Flickering	Slave is missing.
	 (red)	Flickering (10 Hz)	Boot-up was stopped due to an error.
 (off)	Off	No error	
L/A Ch0 & Ch1	LED green		
	 (green)	On	Link: The device is linked to the Ethernet, but does not send/receive Ethernet frames.
	 (green)	Flickering (load dependant)	Activity: The device is linked to the Ethernet and sends/receives Ethernet frames.
	 (off)	Off	The device has no link to the Ethernet.
Ch0 & Ch1	LED yellow		
	 (off)	Off	This LED is not used.

Table 54: LED states for the sercos Master protocol

LED state	Definition
On	The indicator is constantly on.
Off	The indicator is constantly off.
Single flash	The indicator shows one short flash (200 ms) followed by a long "off" phase (1,000 ms).
Double flash	The indicator shows a sequence of two short flashes (each 200 ms), separated by a short off phase (200 ms). The sequence is finished by a long off phase (1,000 ms).
Triple Flash	The indicator shows a sequence of three short flashes (each 200 ms), separated by a short off phase (200 ms). The sequence is finished by a long off phase (1,000 ms).
Quadruple Flash	The indicator shows a sequence of four short flashes (each 200 ms), separated by a short off phase (200 ms). The sequence is finished by a long off phase (1,000 ms).
Blinking (2,5 Hz)	The indicator turns on and off with a frequency of 2,5 Hz: "on" for 200 ms, followed by "off" for 200 ms.
Single Flickering	The indicator is switched on and off once: 'on' for 50 ms, followed by 'off' for 500 ms.
Double Flickering	The indicator is switched on and off and on once: 'on' / 'off' / 'on' each for approximately 50 ms, followed by 'off' for 500 ms.
Flickering (10 Hz)	The indicator turns on and off with a frequency of 10 Hz: 'on' for 50 ms, followed by 'off' for 50 ms.
Flickering (load dependant)	The indicator turns on and off with a frequency of approximately 10 Hz to indicate high Ethernet activity: 'on' for approximately 50 ms, followed by 'off' for 50 ms. The indicator turns on and off in irregular intervals to indicate low Ethernet activity.

Table 55: LED state definitions for the sercos Master protocol

8.13 sercos Slave

For the sercos Slave protocol, the communication LED **S** as well as the Ethernet LED **L/A** can assume the states described below. This description is valid from stack version V3.1.

















LED	Color	State	Meaning
S General name: COM 0	Duo LED red/green (orange = red/green simultaneously)		
	 (green)	On	CP4: Communication phase 4: Normal operation, no error
	 (green)	Blinking (2 Hz)	Loopback: The network state has changed from „fast-forward“ to „loopback“.
	 (green/orange)	Flashing (3 x green/3s)	CP3: Communication phase 3
		(2 x green/3s)	CP2: Communication phase 2
		(1 x green/3s)	CP1: Communication phase 1
	 (orange)	On	CP0: Communication phase 0
	 (orange/green)	Blinking (2 Hz)	HP0: Hot-plug mode (not yet implemented)
		(1 x orange/3s)	HP1: Hot-plug mode (not yet implemented)
		(2 x orange/3s)	HP2: Hot-plug mode (not yet implemented)
	 (orange)	Flashing (2 Hz)	Identification: Corresponds to C-DEV.Bit 15 in the Slave's Device Control indicating remote address allocation or configuration errors between Master and Slaves (for details refer to sercos Slave V3 Protocol API Manual).
	 (green/red)	Flashing (2 Hz, min. 2s)	MST losses \geq (S-0-1003/2): Depends on IDN S-0-1003 (for details refer to sercos Slave Protocol API manual). Corresponds to S-DEV.Bit 15 in the Device Status indicating a communication warning (Master SYNC telegrams have not been received).
	 (red/orange)	Flashing (2 Hz)	Application error (C1D): See GDP & FSP Status codes class error, (see sercos Slave V3 Protocol API Manual).
 (red)	Flashing (2 Hz)	Watchdog error: Application is not running (not yet implemented)	
 (red)	On	Communication Error (C1D): Error detected according to sercos third generation Class 1 Diagnosis, see SCP Status codes class error (see sercos Slave V3 Protocol API Manual).	
 (off)	Off	NRT-Mode: (Non Real-Time Mode) No sercos Communication	
General name: COM 1	Duo LED red/green		
	 (off)	Off	This LED is not used.
L/A Ch0 & Ch1	LED green		
	 (green)	On	Link: The device is linked to the Ethernet, but does not send/receive Ethernet frames.
	 (green)	Flickering (load dependant)	Activity: The device is linked to the Ethernet and sends/receives Ethernet frames.
	 (off)	Off	The device has no link to the Ethernet.
Ch0 & Ch1	LED yellow		
	 (off)	Off	This LED is not used.

Table 56: LED state definitions for the sercos Slave protocol

LED state	Definition
On	The indicator is constantly on.
Off	The indicator is constantly off.
Flashing (2 Hz)	The indicator turns on and off with a frequency of 2 Hz: <i>one color</i> : On for appr. 250 ms, followed by off for appr. 250 ms. <i>two colors</i> : First color for appr. 250 ms, followed by the second color for appr. 250 ms.
Flashing (1 x green/3s) (2 x green/3s) (3 x green/3s) (1 x orange/3s) (2 x orange/3s)	Flashing green for 250 ms, then orange on for 2 second and 750 ms. Flashing green / orange / green, each for 250 ms, then orange on for 2 seconds and 250 ms. Flashing green / orange / green / orange / green, each for 250 ms, then orange on for 1 second and 750 ms. Flashing orange for 250 ms, then green on for 2 second an 750 ms. Flashing orange / green / orange, each for 250 ms, then green on for 2 seconds and 250 ms.
Flickering (load dependant)	The indicator turns on and off with a frequency of approximately 10 Hz to indicate high Ethernet activity: "on" for approximately 50 ms, followed by "off" for 50 ms. The indicator turns on and off in irregular intervals to indicate low Ethernet activity.

Table 57: LED state definitions for the sercos Slave protocol

8.14 VARAN Client (Slave)

For the VARAN Client protocol, the communication LEDs **RUN** and **ERR** as well as the Ethernet LEDs **LINK** and **ACT** can assume the states described below. This description is valid from stack version V1.0.









LED	Color	State	Meaning
RUN General name: COM 0	Duo-LED red/green		
	 (green)	On	Configured and communication is active.
	 (green)	Blinking (5 Hz)	Configured and communication is inactive.
	 (off)	Off	Not configured.
ERR General name: COM 1	Duo-LED red/green		
	 (off)	Off	Configured.
	 (red)	Blinking (5 Hz)	Not configured.
LINK Ch0 & Ch1	LED green		
	 (green)	On	The device is linked to the Ethernet.
	 (off)	Off	The device has no link to the Ethernet.
ACT Ch0 & Ch1	LED yellow		
	 (yellow)	Flickering (load dependant)	The device sends/receives Ethernet frames.
	 (off)	Off	The device does not send/receive Ethernet frames.

Table 58: LED-Zustände für das VARAN-Client-Protokoll

LED state	Definition
On	The indicator is constantly on.
Off	The indicator is constantly off.
Blinking (5 Hz)	The indicator turns on and off with a frequency of 5 Hz: "on" for 100 ms, followed by "off" for 100 ms.
Flickering (load dependant)	The indicator turns on and off with a frequency of approximately 10 Hz to indicate high Ethernet activity: on for approximately 50 ms, followed by off for 50 ms. The indicator turns on and off in irregular intervals to indicate low Ethernet activity.

Table 59: Definitionen der LED-Zustände für das VARAN-Client-Protokoll

8.15 PROFIBUS DP Master

For the PROFIBUS DP Master protocol, the communication status LED **COM** can assume the states described below. This description is valid from stack version V2.6.







LED	Color	State	Meaning
COM	Duo LED red/green		
	 (green)	On	Communication to all Slaves is established.
	 (green)	Flashing (5 Hz)	PROFIBUS is configured, but bus communication is not yet released from the application.
	 (green)	Flashing acyclic	No configuration or faulty configuration
	 (red)	Flashing (5 Hz)	Communication to at least one Slave is disconnected.
	 (red)	On	Communication to all Slaves is disconnected or another serious error has occurred. Redundant Mode: The active Master was not found.
	 (off)	Off	Device is not switched on or network power is missing.

Table 60: LED states for the PROFIBUS DP Master protocol

LED State	Definition
On	The indicator is constantly on.
Off	The indicator is constantly off.
Flashing (5 Hz)	The indicator turns on and off with a frequency of 5 Hz: "on" for 100 ms, followed by "off" for 100 ms.
Flashing acyclic	The indicator turns on and off in irregular intervals.

Table 61: LED state definitions for the PROFIBUS DP Master protocol



Note: For 2-Channel Devices per channel works 1 communication LED.



* Descriptions for 2-Communication Status LEDs of earlier device revisions are included in the user manual for PC cards cifX fieldbus up to manual rev. 23.

8.16 PROFIBUS DP Slave

For the PROFIBUS DP Slave protocol, the communication status LED **COM** can assume the states described below. This description is valid from stack version V2.7.







LED	Color	State	Meaning
COM	Duo LED red/green		
	 (green)	On	RUN, cyclic communication
	 (green)	Flashing, cyclic (2 Hz)	Master is in CLEAR state.
	 (red)	Flashing, acyclic (1 Hz)	Device is not configured.
	 (red)	Flashing, cyclic (2 Hz)	STOP, no communication, connection error
	 (red)	On	Wrong configuration at PROFIBUS DP Slave.
	 (off)	Off	Device is not switched on or network power is missing.

Table 62: LED states for the PROFIBUS DP Slave protocol

LED State	Definition
On	The indicator is constantly on.
Off	The indicator is constantly off.
Flashing, acyclic (1 Hz)	The indicator turns on and off in irregular intervals, with a frequency of 1 Hz: "on" for 750 ms, followed by "off" for 250 ms.
Flashing, cyclic (2 Hz)	The indicator turns on and off with a frequency of 2 Hz: "on" for 250 ms, followed by "off" for 250 ms.

Table 63: LED state definitions for the PROFIBUS DP Slave protocol



Note: For 2-Channel Devices per channel works 1 communication LED.



* Descriptions for 2-Communication Status LEDs of earlier device revisions are included in the user manual for PC cards cifX fieldbus up to manual rev. 23.

8.17 PROFIBUS MPI Device

For the PROFIBUS MPI protocol, the communication status LED **COM** can assume the states described below. This description is valid from stack version V2.4.





LED	Color	State	Meaning
COM	Duo LED red/green		
	 (green)	On	Status: The device currently holds the PROFIBUS token and is able to transfer telegrams of data.
	 (green)	Blinking (5 Hz)	Status: The device is configured to be a part of the PROFIBUS ring, but it must share the PROFIBUS token with other PROFIBUS-Master devices present on the PROFIBUS ring.
	 (green)	Blinking (0.5 Hz)	Status: Automatic baudrate detection is running
	 (off)	Off	Status: The device has not been integrated into the PROFIBUS ring, i.e. it has not been configured correctly or has a wrong configuration or has not received the PROFIBUS token.

Table 64: LED states for the PROFIBUS MPI protocol

LED State	Definition
On	The indicator is constantly on.
Off	The indicator is constantly off.
Blinking (5 Hz)	The indicator turns on and off with a frequency of appr. 5 Hz: "on" for appr. 100 ms, followed by "off" for appr. 100 ms.
Blinking (0.5 Hz)	The indicator turns on and off with a frequency of appr. 0.5 Hz: "on" for appr. 1000 ms, followed by "off" for appr. 1000 ms.

Table 65: LED state definitions for the PROFIBUS MPI protocol

8.18 CANopen Master

For the CANopen Master protocol, the communication status LED **CAN** can assume the states described below. This description is valid from stack version V2.11.







LED	Color	State	Meaning
CAN	Duo-LED red/green		
	 (green)	On	OPERATIONAL: The device is in the OPERATIONAL state.
	 (green)	Blinking (2,5 Hz)	PREOPERATIONAL: The device is in the PREOPERATIONAL state.
	 (green)	Single flash	STOPPED: The device is in STOPPED state.
	 (red)	Single flash	Warning Limit reached: At least one of the error counters of the CAN controller has reached or exceeded the warning level (too many error frames).
	 (red)	Double flash	Error Control Event: A guard event (NMT Slave or NMT Master) or a heartbeat event (Heartbeat consumer) has occurred.
	 (red)	On	Bus Off: The CAN controller is in bus OFF state.
	 (aus)	Off	RESET: The device is executing a reset or the device has no configuration.

Table 66: LED states for the CANopen Master protocol

LED state	Definition
On	The indicator is constantly on.
Off	The indicator is constantly off.
Blinking (2,5 Hz)	The indicator turns on and off with a frequency of 2,5 Hz: "on" for 200 ms, followed by "off" for 200 ms.
Single flash	The indicator shows one short flash (200 ms) followed by a long "off" phase (1,000 ms).
Double flash	The indicator shows a sequence of two short flashes (each 200 ms), separated by a short "off" phase (200 ms). The sequence is finished by a long "off" phase (1,000 ms).

Table 67: LED state definitions for the CANopen Master protocol



* Descriptions for 2-Communication Status LEDs of earlier device revisions are included in the user manual for PC cards cifX fieldbus up to manual rev. 23.

8.19 CANopen Slave

For the CANopen Slave protocol, the communication status LED **CAN** can assume the states described below. This description is valid from stack version V3.4.









LED	Color	State	Meaning
cifX with 1 Communication Status LED (current Hardware Revision)			
CAN	Duo LED red/green		
	 (green)	On	OPERATIONAL: The device is in the OPERATIONAL state.
	 (green)	Blinking (2.5 Hz)	PREOPERATIONAL: The device is in the PREOPERATIONAL state.
	 (green)	Single flash	STOPPED: The device is in STOPPED state.
	 (red/green)	Flickering (10 Hz)	Auto Baud Rate Detection active: The Device is in the auto baud rate detection mode.
	 (red)	Single flash	Warning Limit reached: At least one of the error counters of the CAN controller has reached or exceeded the warning level (too many error frames).
	 (red)	Double flash	Error Control Event: A guard event (NMT Slave or NMT Master) or a heartbeat event (Heartbeat consumer) has occurred.
	 (red)	On	Bus Off: The CAN controller is in bus OFF state.
 (off)	Off	RESET: The device is executing a reset or the device has no configuration.	

Table 68: States of the CAN LED for the CANopen Slave protocol – 1 Communication Status LED (current Hardware Revision)

LED State	Definition
On	The indicator is constantly on.
Off	The indicator is constantly off.
Flickering (10 Hz)	The indicator turns on and off with a frequency of 10 Hz: “on” for 50 ms, followed by “off” for 50 ms.
Blinking (2.5 Hz)	The indicator turns on and off with a frequency of 2,5 Hz: “on” for 200 ms, followed by “off” for 200 ms.
Single Flash	The indicator shows one short flash (200 ms) followed by a long “off” phase (1,000 ms).
Double Flash	The indicator shows a sequence of two short flashes (each 200 ms), separated by a short off phase (200 ms). The sequence is finished by a long “off” phase (1,000 ms).

Table 69: LED state definitions for the CANopen Slave protocol



* Descriptions for 2-Communication Status LEDs of earlier device revisions are included in the user manual for PC cards cifX fieldbus up to manual rev. 23.

8.20 DeviceNet Master

For the DeviceNet Master protocol, the communication status LED **MNS** can assume the states described below. This description is valid from stack version V2.3.







LED	Color	State	Meaning
MNS	Duo LED red/green		
	 (green)	On	Device operational AND on-line, connected Device is online and has established all connections with all Slaves.
	 (green)	Flashing (1 Hz)	Device operational AND on-line Device is online and has established no connection in the established state. - Configuration missing, incomplete or incorrect.
	 (green/red/Off)	Flashing (2Hz) Green/Red/Off	Self test after power on
	 (red)	Flashing (1 Hz)	Minor fault and/or connection time-out Device is online and has established one or more connections in the established state. It has data exchange with at least one of the configured Slaves. Minor or recoverable fault: No data exchange with one of the configured Slaves. One or more Slaves are not connected. Connection timeout Minor or recoverable fault: No data exchange with one of the configured Slaves. One or more Slaves are not connected. Connection timeout. No network power present.
	 (red)	On	Critical fault or critical link failure Critical connection failure; device has detected a network error: duplicate MAC-ID or severe error in CAN network (CAN-bus off).
 (off)	Off	Device is not powered - The device may not be powered. Device is not on-line and/or no network power - The device has not yet completed the Dup_MAC_ID test. - The device is powered, but the network power is missing.	

Table 70: LED states for the DeviceNet Master protocol

LED state	Definition
On	The indicator is constantly on.
Off	The indicator is constantly off.
Flashing (1 Hz)	The indicator turns on and off with a frequency of appr. 1 Hz: on for appr. 500 ms, followed by off for appr. 500 ms.
Flashing (2 Hz) green/red/off	The indicator turns on green on for 250 ms, then red on for 250 ms, then off.

Table 71: LED state definitions for the DeviceNet Master protocol

8.21 DeviceNet Slave

For the DeviceNet Slave protocol, the communication status LED **MNS** can assume the states described below. This description is valid from stack version V2.3.







LED	Color	State	Meaning
MNS	Duo LED red/green		
	 (green)	On	Device operational AND on-line, connected Device is online and has established all connections with all Slaves.
	 (green)	Flashing (1 Hz)	Device operational AND on-line Device is online and has established no connection in the established state. - Configuration missing, incomplete or incorrect.
	 (green/red/Off)	Flashing (2Hz) Green/Red/Off	Self test after power on
	 (red)	Flashing (1 Hz)	Minor fault and/or connection time-out Device has no connectin to the Master. Minor or recoverable fault: No data exchange with the Master. Connection timeout. No network power present.
	 (red)	On	Critical fault or critical link failure Critical connection failure; device has detected a network error: duplicate MAC-ID or severe error in CAN network (CAN-bus off).
	 (off)	Off	Device is not powered - The device may not be powered. Device is not on-line and/or no network power - The device has not yet completed the Dup_MAC_ID test. - The device is powered, but the network power is missing.

Table 72: LED states for the DeviceNet Slave protocol

LED state	Definition
On	The indicator is constantly on.
Off	The indicator is constantly off.
Flashing (1 Hz)	The indicator turns on and off with a frequency of appr. 1 Hz: on for appr. 500 ms, followed by off for appr. 500 ms.
Flashing (2 Hz) green/red/off	The indicator turns on green on for 250 ms, then red on for 250 ms, then off.

Table 73: LED state definitions for the DeviceNet Slave protocol

8.22 AS Interface Master

For the AS-Interface Master protocol, the communication status LED **COM** can assume the states described below. This description is valid from stack version V2.3.







LED	Color	State	Meaning
COM	Duo LED red/green		
	 (green)	On	No configuration error, data exchange active
	 (green)	Flashing	Configuration error, data exchange active
	 (green)	Flickering	The communication is stopped.
	 (red/green)	Flashing	„Configuration mode“ active
	 (red)	Flashing	AS-Interface power fail
	 (red)	On	Heavy system error or hardware failure
	 (off)	Off	No configuration found for this channel

Table 74: LEDs states for the AS-Interface Master protocol

LED State	Definition
On	The indicator is constantly on.
Off	The indicator is constantly off.
Flashing	The indicator turns on and off cyclically in slowly changing phases.
Flickering	The indicator turns on and off cyclically in rapidly changing phases.

Table 75: LED state definitions for the AS-Interface Master protocol

8.23 CC-Link Slave

For the CC-Link Slave protocol, the communication status LEDs **L-RUN** and **L-ERR** can assume the states described below. This description is valid from stack version V2.9.





LED	Color	State	Meaning
L RUN	LED green		
	 (green)	On	After participating in the network, the device receives both refresh and polling signals or just the refresh signal normally.
	 (off)	Off	1. Before participating in the network 2. Unable to detect carrier 3. Timeout 4. Resetting hardware
L ERR	LED red		
	 (red)	Blinking	The switch setting has been changed from the setting at the reset cancellation (blinks for 0.4 sec.).
	 (red)	On	1. CRC error 2. Address parameter error (0,65 or greater is set including the number of occupied stations) 3. Baud rate switch setting error during cancellation of reset (5 or greater)
	 (off)	Off	1. Normal communication 2. Resetting hardware

Table 76: LED states for the CC-Link Slave protocol

LED state	Definition
On	The indicator is constantly on.
Off	The indicator is constantly off.
Blinking	The indicator turns on and off cyclically.

Table 77: LED state definitions for the CC-Link Slave protocol

9 Device Connections and Switches

9.1 Ethernet Interface

For the Ethernet interface use RJ45 plugs and twisted pair cable of category 5 (CAT5) or higher, which consists of 4 twisted cores and has a maximum transmission rate of 100 MBit/s (CAT5).

9.1.1 Ethernet Pin Assignment at the RJ45 Socket



Note: The device supports the **Auto Crossover** function. Due to this fact RX and TX can be switched. The following figure shows the RJ45 standard pin assignment.

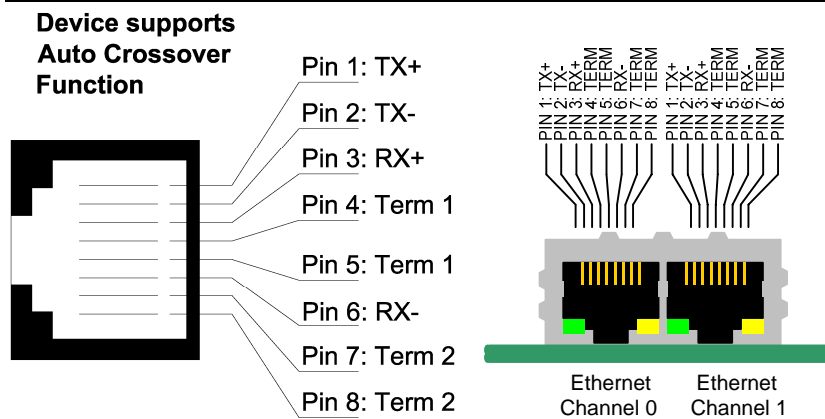

Figure 49: Ethernet Pin Assignment at the RJ45 Socket for cifX or AIFX

Pin	Signal	Meaning
1	TX+	Transmit Data +
2	TX-	Transmit Data -
3	RX+	Receive Data +
4	Term 1	Connected to each other and terminated to PE through RC circuit*
5	Term 1	
6	RX-	Receive Data -
7	Term 2	Connected to each other and terminated to PE through RC circuit*
8	Term 2	
		* Bob Smith Termination

Table 78: Ethernet Pin Assignment at the RJ45 Socket for cifX or AIFX



Further Notes:

- (1) The RJ45 socket is only for use in LAN, not for telecommunication circuits.
- (2) With loaded EtherCAT Master firmware only the RJ45 channel 0 can be used, channel 1 is deactivated. Beginning with the EtherCAT Master firmware version 3 channel 1 can be reactivated if redundancy is activated. For the Open Modbus/TCP firmware with V2.3.4.0 and higher both RJ45channels can be used.

9.1.2 Ethernet Connection Data

Medium	2 x 2 Twisted-Pair cupric cable, CAT5 (100 MBit/s)
Length of cable	Typ. 100 m
Transmission rate	10 MBit/s/100 MBit/s

Table 79: Ethernet Connection Data

9.1.3 Use of Hubs and Switches

For the corresponding communication systems, the use of hubs and/or switches is either forbidden or allowed. The following table shows the acceptable use of hubs and switches by each communication system:

Communication System	Hub	Switch
EtherCAT	forbidden	only allowed between EtherCAT Master and first EtherCAT Slave (100 MBit/s, Full Duplex)
EtherNet/IP	allowed	allowed (10 MBit/s/100 MBit/s, Full or Half Duplex, Auto-Negotiation)
Open Modbus/TCP	allowed	allowed (10 MBit/s/100 MBit/s, Full or Half Duplex, Auto-Negotiation)
POWELINK	allowed	forbidden
PROFINET IO	forbidden	Only allowed if the switch supports 'Priority Tagging' and LLDP (100 MBit/s, Full Duplex)
sercos	forbidden	forbidden
VARAN*	forbidden	forbidden

Table 80: Use of Hubs and Switches

*Instead of hubs and switches VARAN uses splitter. [3]

9.2 PROFIBUS Interface

Isolated RS-485 interface:

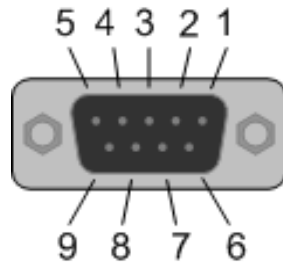

Figure 50: PROFIBUS Interface (DSub female connector, 9 pin), X400

Connection with DSub female connector	Signal	Meaning
3	RxD/TxD-P	Receive/Send Data-P respectively connection B plug
5	DGND	Reference potential
6	VP	Positive supply voltage
8	RxD/TxD-N	Receive/Send Data-N respectively connection A plug

Table 81: PROFIBUS Interface, X400

9.3 CANopen Interface

Isolated ISO 11898 interface:

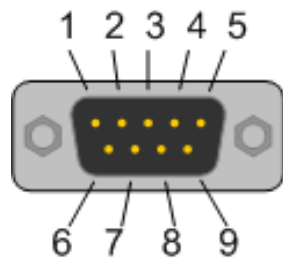

Figure 51: CANopen Interface (DSub male connector, 9 pin), X400

Connection with DSub male connector	Signal	Description
2	CAN_L	CAN_Low Bus Line
3	CAN_GND	CAN Ground
7	CAN_H	CAN High Bus Line
1, 4, 5, 6, 8, 9		Do not connect!

Table 82: CANopen Interface, X400

9.4 DeviceNet Interface

Isolated ISO 11898 interface:

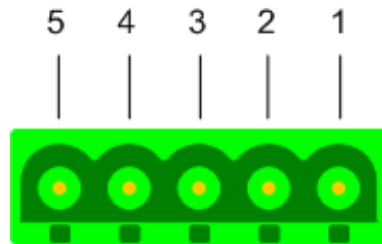

Figure 52: DeviceNet Interface (CombiCon male Connector, 5 pin), X360

Connection with CombiCon male connector	Signal	Color	Description
1	V-	Black	Reference potential DeviceNet supply voltage
2	CAN_L	Blue	CAN Low-Signal
3	Drain		Shield
4	CAN_H	White	CAN High-Signal
5	V+	Red	+24 V DeviceNet supply voltage

Table 83: DeviceNet Interface, X360

9.5 AS-Interface Interface

The AS-Interface Master conforms to Complete Specification 2.11 (Annex B, Version 2.0) the profile M3 (Full Extended Master).

AS-Interface interface according to IEC 364-4-41.

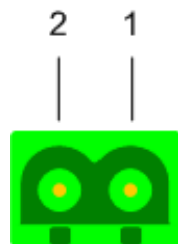

Figure 53: AS-Interface Interface (CombiCon male Connector, 2 pin)

Connection with CombiCon male connector	Signal	Description
1	AS-i +	AS-Interface positive voltage
2	AS-i -	AS-Interface negative voltage

Table 84: AS-Interface Interface

9.6 CC-Link Interface

Isolated RS-485 interface:

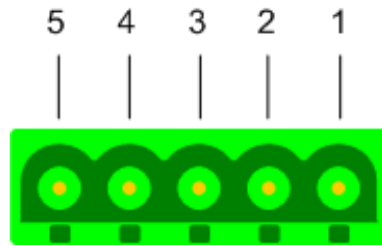

Figure 54: CC-Link Interface (CombiCon male Connector, 5 pin)

Connection with Screw terminal Connector	Signal	Meaning
1	DA	Data A
2	DB	Data B
3	DG	Data Ground
4	SLD	Shield
5	FG	Field Ground

Table 85: CC-Link Interface

9.7 Rotary Switch for Slot Number (Card ID)

Device revisions equipped with a **Rotary Switch Slot Number (Card ID)** are listed separately in section *Hardware: PC Cards cifX* in *Table 2* on page 10.

The **Rotary Switch Slot Number (Card ID)** serves to set the **Slot Number (Card ID)** of the PC cards cifX.

The figure below describes possible switch positions of the **Rotary Switch Slot Number (Card ID)**.



Switch Position	Meaning
0	<p>The value 0 means:</p> <ul style="list-style-type: none"> ▪ no Slot Number (Card ID), i. e. the Slot Number (Card ID) is not used, ▪ for downwards compatibility purposes, ▪ characterizes PC cards cifX not equipped with a Rotary Switch Slot Number (Card ID); i. e. these PC cards cifX are identified via its device number and serial number.
	<p>Example</p> <p>Rotary Switch Slot Number (Card ID) Switch Position 0</p>
1 ... 9	<p>corresponds to the Slot Number (Card ID) 1 ... 9</p>
	<p>Example</p> <p>Rotary Switch Slot Number (Card ID) Switch Position 1</p>

Table 86: Rotary Switch for Slot Number (Card ID), S1

9.7.1 Set Slot Number (Card ID)

If the Slot Number (Card ID) shall not be used:

- set the value 0.

Or

If the Slot Number (Card ID) shall be used:

- Set a value from 1 to 9.



For further information about the **Slot Number (Card ID)** refer to section *The Function „Slot Number (Card ID)“* (page 29) or to the user manual **Software Installation for the PC Cards cifX**, sections *Slot Number (Card ID) in the cifX Device Driver Setup* and *Slot Number (Card ID) in the Configuration Software*.

9.7.2 Note for Device Exchange Service (Replacement Case):



Important: For PC cards cifX with **Rotary Switch Slot Number (Card ID)** in terms of a device exchange service (replacement case) you must set at the replacement card cifX the same **Slot Number (Card ID)** as at the preceding cifX. Then the same firmware and configuration is loaded into the replacement card cifX, as into the preceding cifX.

9.7.3 Rotary Switch Slot Number PC Cards cifX Low Profile

The *Table 87* below shows the **Rotary Switch Slot Number (Card ID)** of the PC cards cifX Low Profile PCI Express in switch position 0 and 1.

	Description
	<p>Rotary Switch Slot Number (Card ID) Switch Position 0</p>
	<p>Rotary Switch Slot Number (Card ID) Switch Position 1</p>

Table 87: Rotary Switch Slot Number (Card ID) PC Cards cifX Low Profile PCI Express

9.8 SYNC Connector (Pin-Assignment, Hardware/Firmware)

9.8.1 Pin Assignment SYNC Connector, X51 (CIFX 50 50E 70E)

Only for:

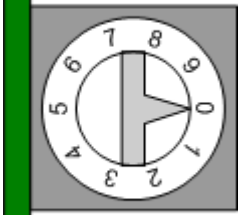
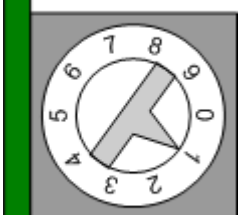
CIFX 50-RE (from hardware Rev. 3 on), CIFX 50-RE\ET, CIFX 50E-RE, CIFX 50E-RE\ET, CIFX 70E-RE

Pin	Signal
1	GND
2	IO_SYNC0
3	IO_SYNC1

Table 88: Pin Assignment for SYNC Connector, X51

9.8.2 Pin Assignment SYNC Connector, J1 (CIFX 100EH)

Only for: CIFX 100EH-RE\CUBE.

Pin	Signal
1	IO_SYNC0
2	<i>Jumper set:</i> SYNC signal is transferred to the PCI Express Bus Pin B24*
	<i>Jumper not set:</i> static high 3.3 V (with pull-up)
3	IO_SYNC1

Table 89: Pin Assignment for SYNC Connector, J1



Note! *

- If the jumper is set on Pin1-Pin2, then the **IO_SYNC0** signal will be transferred to the PCI Express Bus X2 (pin B24).

Or

- If the jumper is set on Pin2-Pin3, then the **IO_SYNC1** signal will be transferred to the PCI Express Bus X2 (pin B24).

Or

- If the no jumper is set, then the signal at the PCI Express Bus X2 pin B24 will be static High **3.3 V** (with pull-up).

Compare section *Pin Assignment for PCI Express Bus CIFX 100EH-RE\CUBE* on page 115.

9.8.3 Items on Hardware

Item	Explanation
SYNC Signal	3.3 V (LVTTTL), maximum load 6 mA
Connector	<p><u>SYNC connector, X51</u> (for the PC cards cifX, as indicated under section <i>Pin Assignment SYNC Connector, X51</i> (CIFX 50 50E 70E) on page 112.) Female connector, 3 pin, pitch spacing 1.25 mm (for example, the type Molex series 51021) and female crimp contacts in design (e. g. type Molex series 50079/50058)</p> <p><u>SYNC connector, J1</u> (for CIFX 100EH-RE\CUBE) Male Connector with jumper, 3 pin, pitch spacing 2,54 mm</p>
Max. Cable Length	<p>Recommendation: Max. 50 mm</p> <p>Note: Take EMC into consideration for the cable laying</p>

Table 90: SYNC Connector: SYNC Signal, Connector, Max. Cable Length

9.8.4 Items on Firmware

The firmware determines the input signal or output signal. The following table shows the meaning of the SYNC signals for each protocol.

Protocol	Signal IO_SYNC0 Input/Output	Signal IO_SYNC1 Input/Output	From Firmware Version	Remarks
EtherCAT Slave	SYNC 0 Output	SYNC 1 Output	-	Configurable
sercos Master	External trigger to start bus cycle Input Rising edge	-	2.0.8.0	-
sercos Slave	CON_CLK Output	DIV_CLK Output	3.0.10.0	Configurable

Table 91: Meaning of the SYNC Signals for each Protocol

9.9 Pin Assignment at the PCI Bus

9.9.1 Overview

For the PC cards cifX PCI, PCI Express and Low Profile PCI Express the table below gives an overview about the pin assignment at the PCI bus.

PC Card cifX	Hardware Revision	PCI Bus Type	PCI Bus [Pins]	Pin Assignment at the PCI Bus		PCI Specification
				acc. to standard	compare section, page	
CIFX 50-RE CIFX 50-RE\ET CIFX 50-DP CIFX 50-CO CIFX 50-DN CIFX 50-CC CIFX 50-2DP CIFX 50-2DP\CO CIFX 50-2DP\DN CIFX 50-2CO CIFX 50-2CO\DN CIFX 50-2DN CIFX 50-2ASM	5 1 5 5 5 2 3 2 1 2 1 2 2	PCI	124	yes	-	[bus spec 1]
CIFX 50E-RE CIFX 50E-RE\ET CIFX 50E-DP CIFX 50E-CO CIFX 50E-DN CIFX 50E-2ASM CIFX 50E-CC	5 1 6 5 5 5 4	PCI Express	36	yes	-	[bus spec 2, Rev. 2.0], [bus spec 3]
CIFX 70E-RE, CIFX 70E-RE\MR, CIFX 70E-DP, CIFX 70E-DP\MR, CIFX 70E-CO, CIFX 70E-COMR, CIFX 70E-DN, CIFX 70E-DNMR	1 1 1 1 1 1 1 1					
CIFX 100EH-RE\ CUBE	4	PCI Express	64	no	<i>Pin Assignment for PCI Express Bus CIFX 100EH-RE\CUBE, 115</i>	[bus spec 2, Rev. 2.0], [bus spec 3]

Table 92: Pin Assignment at the PCI Bus

9.9.2 References PCI Specifications

No.	Specification	Revision	Version	Date	www
[bus spec 1]	PCI Local Bus Specification	2.3	-	February 21, 2003	pcisig.com
[bus spec 2]	PCI Express® Base Specification	2.0	-	January 15, 2007	
[bus spec 3]	PCI Express® Card Electromechanical Specification	2.0	-	April 11, 2007	

Table 93: References PCI Specifications

9.9.3 Pin Assignment for PCI Express Bus CIFX 100EH-RE\CUBE

Only for: CIFX 100EH-RE\CUBE (x1 = One Lane)²

PCI Express Bus X2 (Side B)			PCI Express Bus X1 (Side A)		
Pin	Name	Description	Pin	Name	Description
B1	n. u.	(not used)	A1	PRSNT1#	Hot-Plug presence detect
B2	n. u.	(not used)	A2	n. u.	(not used)
B3	n. u.	(not used)	A3	n. u.	(not used)
B4	GND	Ground	A4	GND	Ground
B5	n. u.	(not used)	A5	JTAG-TCK	JTAG Test Clock
B6	n. u.	(not used)	A6	JTAG-TDI	JTAG Test Data Input
B7	GND	Ground	A7	JTAG-TDO	JTAG Test Data Output
B8	3V3	3.3V Power	A8	JTAG-TMS	JTAG Test Mode Select Input
B9	JTAG-TRST#	JTAG Test Reset	A9	3V3	3.3V Power
B10	n. v.	(not used)	A10	3V3	3.3V Power
B11	n. u.	(not used)	A11	PERST#	PCIe Reset
Key					
B12	n. u.	(not used)	A12	GND	Ground
B13	GND	Ground	A13	PCIe_CLK+	PCIe Clock differential pair
B14	PCIe_TP	Transmitter Lane, differential pair	A14	PCIe_CLK-	
B15	PCIe_TN		A15	GND	Ground
B16	GND	Ground	A16	PCIe_RP	Receiver Lane, differential pair
B17	PRSNT2#	Hot-Plug presence detect	A17	PCIe_RN	
B18	GND	Ground	A18	GND	Ground
B19	n. u.	(not used)	A19	n. u.	(not used)
B20	n. u.	(not used)	A20	n. u.	(not used)
B21	n. u.	(not used)	A21	n. u.	(not used)
B22	n. u.	(not used)	A22	n. u.	(not used)
B23	GND	Ground	A23	n. u.	(not used)
B24	IO_SYNC0 / IO_SYNC1 / 3.3V ³	Real-Time Ethernet SYNC ⁴	A24	n. u.	(not used)
B25	GND	Ground	A25	n. u.	(not used)
B26	SPI_CS#	ID Chip Select	A26	n. u.	(not used)
B27	SPI_MOSI	ID Slave In	A27	n. u.	(not used)
B28	SPI_MISO	ID Slave Out	A28	n. u.	(not used)
B29	SPI_CLK	ID Clock	A29	n. u.	(not used)
B30	GND	Ground	A30	n. u.	(not used)
B31	n. u.	(not used)	A31	n. u.	(not used)
B32	n. u.	(not used)	A32	n. u.	(not used)

Table 94: Pin Assignment for PCI Express-Bus CIFX 100EH-RE\CUBE

²Pinning A19 to A32 / B19 to B32 not standard conform [bus spec 3, page 73-74].

³If at the SYNC connector J1 the jumper is set, the IO_SYNC signal is transferred to the PCI Express Bus X2 pin B24 (jumper on pin1-pin2(J1): **IO_SYNC0**, pin2-pin3(J1): **IO_SYNC1**). If no jumper is set, the signal is **3,3V** static High (with Pull-up). Refer to section *Pin Assignment SYNC Connector, J1 (CIFX 100EH)*, on page 112.

⁴in 3V3 logic.

10 Technical Data

10.1 Technical Data PC Cards cifX



Note: All technical data are temporarily and can be altered without notice.

10.1.1 CIFX 50-RE, CIFX 50-RE\ET

CIFX 50-RE, CIFX 50-RE\ET	Parameter	Value	
Part	Name	CIFX 50-RE	CIFX 50-RE\ET
	Part No.	1250.100	1250.105
	Description	PC Card cifX PCI Real-Time Ethernet Master or Slave	
	Function	Communication interface with PCI and Ethernet interface	
Communication Controller	Type	netX 500 processor	
Integrated Memory	RAM	8 MB SDRAM	
	FLASH	4 MB serial Flash EPROM	
	Size of the Dual-Port Memory	64 KByte	
System Interface	Bus Type	PCI, according to [bus spec 1], refer to section <i>Overview</i> , page 114.	
	Transmission Rate	33 MHz	
	Data Access	DPM or DMA (Direct Memory Access)	
	Width for the data access to the Dual-Port Memory (DPM)	32-Bit	
Ethernet Communication	Supported Real-Time Ethernet communication systems (determined by the loaded firmware)	EtherCAT Master, EtherCAT Slave	
		EtherNet/IP Scanner (Master), EtherNet/IP Adapter (Slave),	
		Open Modbus/TCP	
		POWERLINK Controlled Node/Slave	
		PROFINET IO-Controller (Master), PROFINET IO-Device (Slave)	
		sercos Master, sercos Slave	
	VARAN Client (Slave)		
Ethernet Frame Types	Ethernet II		
Ethernet Interface	Transmission rate	100 MBit/s, 10 MBit/s (depending on loaded firmware)	
	Interface Type	100 BASE-TX, 10 BASE-T (depending on loaded firmware), refer to section <i>Ethernet Interface</i> , page 105.	
	Galvanic Isolation	isolated	
	Isolation Voltage	1000 VDC (tested for 1 minute)	
	Half duplex/Full duplex	depending on loaded firmware, supported (at 100 MBit/s)	
	Auto-Negotiation	depending on loaded firmware	
	Auto-Crossover	depending on loaded firmware	
	Connector	2* RJ45 Socket	
	Channel 0 and 1	With loaded EtherCAT Master firmware only the RJ45 channel 0 can be used, channel 1 is deactivated. Beginning with the EtherCAT Master firmware version 3 channel 1 can be reactivated if redundancy is activated. For Open Modbus/TCP with V2.3.4.0 and higher both	

CIFX 50-RE, CIFX 50-RE\ET	Parameter	Value	
		RJ45 channels can be used.	
Display	LED Display	SYS System Status LED The meaning of the following LEDs depends on the loaded firmware: COM 0 LED Communication Status 0 (duo LED) COM 1 LED Communication Status 1 (duo LED) LED yellow at RJ45Ch0 and RJ45Ch1, LED green for Ethernet Link status, Ethernet Activity status and additional status Refer to chapter <i>LED Descriptions</i> , page 80.	
Power supply	Supply Voltage	+3.3 V dc \pm 5 %, refer to section <i>Power Supply and Host Interface</i> , page 34.	
	Maximum Current at 3.3 V (typically)	650 mA	
	Connector	Via PCI Bus	
Operation	Rotary Switch Slot Number (Card ID)	To set the Slot Number (Card ID)	
Environmental Conditions		CIFX 50-RE	CIFX 50-RE\ET
	Operating temperature range*	0 °C ... +55 °C	0 °C ... +70 °C
	*Air flow during measurment	0,5m/s	
	Storage temperature range	0 °C ... +70 °C	
	Humidity	10 ... 95% relative humidity, no condensation permitted	
	Environment	For UL compliant usage: The device must be used in a pollution degree 2 environment.	
Device	Dimensions (L x W x H)	120,0 x 86 x 18,5 mm (from hardware revision 3)	
	Mounting/Installation	PCI slot (3.3 V), refer to section <i>Slot for the PC Cards cifX PCI, PCIe and Low Profile PCIe</i> , page 33.	
	RoHS	Yes	
CE Sign	CE Sign	Yes	
	Emission	EN 55011:2009 + A1:2010, CISPR 11:2009, Class A (Radio disturbance characteristics - Limits and methods of measurement)	
	Immunity	EN 61000-4-2:2009 (Electrostatic discharge test) EN 61000-4-3:2006 + A1:2008 + A2:2010 (Radiated, radio-frequency, electromagnetic field test) EN 61000-4-4:2004 + A1:2010 (Burst Electrical fast transients/burst test) EN 61000-4-5:2006 (Surge test) EN 61000-4-6:2009 (to conducted disturbances, induced by radio- frequency fields) EN 61000-4-8:2010 (power frequency magnetic field test) EN 61000-6-2:2005 + B1:2011 (for industrial environments)	
UL Certification	The device CIFX 50-RE is certified according to UL 508.	UL-File-Nr. E221530	
Configuration	Configuration Software Master and Slave	SYCON.net	
	Configuration Software Slave	netX Configuration Tool	

Table 95: Technical Data CIFX 50-RE, CIFX 50-RE\ET

10.1.2 CIFX 50E-RE, CIFX 50E-RE\ET

CIFX 50E-RE, CIFX 50E-RE\ET	Parameter	Value	
Part	Name	CIFX 50E-RE	CIFX 50E-RE\ET
	Part No.	1251.100	1251.105
	Description	PC Card cifX PCI Express Real-Time Ethernet Master or Slave	
	Function	Communication interface with PCI Express and Ethernet interface	
Communication Controller	Type	netX 500 processor	
Integrated Memory	RAM	8 MB SDRAM	
	FLASH	4 MB serial Flash EPROM	
	Size of the Dual-Port Memory	64 KByte	
System Interface	Bus Type	PCI Express, One Lane Port, according to [bus spec 2, Rev. 2.0] and [bus spec 3], refer to section <i>Overview</i> , page 114.	
	Transmission Rate	2 GBit/s	
	Data Access	DPM or DMA* (Direct Memory Access); *beginning from Hardware Revision 4	
	Width for the data access to the Dual-Port Memory (DPM)	32-Bit	
Ethernet Communication	Supported Real-Time Ethernet communication systems (determined by the loaded firmware)	EtherCAT Master, EtherCAT Slave	
		EtherNet/IP Scanner (Master), EtherNet/IP Adapter (Slave),	
		Open Modbus/TCP	
		POWERLINK Controlled Node/Slave	
		PROFINET IO-Controller (Master), PROFINET IO-Device (Slave)	
		sercos Master, sercos Slave	
	VARAN Client (Slave)		
Ethernet Frame Types	Ethernet II		
Ethernet Interface	Transmission rate	100 MBit/s, 10 MBit/s (depending on loaded firmware)	
	Interface Type	100 BASE-TX, 10 BASE-T (depending on loaded firmware), refer to section <i>Ethernet Interface</i> , page 105.	
	Galvanic Isolation	isolated	
	Isolation Voltage	1000 VDC (tested for 1 minute)	
	Half duplex/Full duplex	depending on loaded firmware, supported (at 100 MBit/s)	
	Auto-Negotiation	depending on loaded firmware	
	Auto-Crossover	depending on loaded firmware	
	Connector	2* RJ45 Socket	
Channel 0 and 1	With loaded EtherCAT Master firmware only the RJ45 channel 0 can be used, channel 1 is deactivated. Beginning with the EtherCAT Master firmware version 3 channel 1 can be reactivated if redundancy is activated. For Open Modbus/TCP with V2.3.4.0 and higher both RJ45 channels can be used.		

CIFX 50E-RE, CIFX 50E-RE\ET	Parameter	Value	
Display	LED Display	<p>SYS System Status LED</p> <p>The meaning of the following LEDs depends on the loaded firmware:</p> <p>COM 0 LED Communication Status 0 (duo LED)</p> <p>COM 1 LED Communication Status 1 (duo LED)</p> <p>LED yellow at RJ45Ch0 and RJ45Ch1, for Ethernet Link status, Ethernet Activity status and additional status</p> <p>LED green</p> <p>Refer to chapter <i>LED Descriptions</i>, page 80.</p>	
Power supply	Supply Voltage	+3.3 V dc $\pm 5\%$, refer to section <i>Power Supply and Host Interface</i> , page 34.	
	Maximum Current at 3.3 V (typically)	800 mA	
	Connector	Via PCI Express Bus	
Operation	Rotary Switch Slot Number (Card ID)	To set the Slot Number (Card ID)	
Environmental Conditions		CIFX 50E-RE	CIFX 50E-RE\ET
	Operating temperature range*	0 °C ... +55 °C	0 °C ... +70 °C
	*Air flow during measurement	0,5m/s	
	Storage temperature range	0 °C ... +70 °C	
	Humidity	10 ... 95% relative humidity, no condensation permitted	
	Environment	For UL compliant usage: The device must be used in a pollution degree 2 environment.	
Device	Dimensions (L x W x H)	120,0 x 86 x 18,5 mm (from hardware revision 4)	
	Mounting/Installation	PCI Express x1 slot (3.3 V), refer to section <i>Slot for the PC Cards cifX PCI, PCIe and Low Profile PCIe</i> , page 33.	
	RoHS	Yes	
CE Sign	CE Sign	Yes	
	Emission	EN 55011:2009 + A1:2010, CISPR 11:2009, Class A (Radio disturbance characteristics - Limits and methods of measurement)	
	Immunity	EN 61000-4-2:2009 (Electrostatic discharge test) EN 61000-4-3:2006 + A1:2008 + A2:2010 (Radiated, radio-frequency, electromagnetic field test) EN 61000-4-4:2004 + A1:2010 (Burst Electrical fast transients/burst test) EN 61000-4-5:2006 (Surge test) EN 61000-4-6:2009 (to conducted disturbances, induced by radio- frequency fields) EN 61000-4-8:2010 (power frequency magnetic field test) EN 61000-6-2:2005 + B1:2011 (for industrial environments)	
UL Certification	The device CIFX 50E-RE is certified according to UL 508.	UL-File-Nr. E221530	
Configuration	Configuration Software Master and Slave	SYCON.net	
	Configuration Software Slave	netX Configuration Tool	

Table 96: Technical Data CIFX 50E-RE, CIFX 50E-RE\ET

10.1.3 CIFX 50-DP

CIFX 50-DP	Parameter	Value
Part	Name	CIFX 50-DP
	Part No.	1250.410
	Description	PC Card cifX PCI PROFIBUS DP Master or Slave and PROFIBUS MPI Device
	Function	Communication interface with PCI and PROFIBUS interface
Communication Controller	Type	netX 100 processor
Integrated Memory	RAM	8 MB SDRAM
	FLASH	4 MB serial Flash EPROM
	Size of the Dual-Port Memory	64 KByte
System Interface	Bus Type	PCI, according to [bus spec 1], refer to section <i>Overview</i> , page 114.
	Transmission Rate	33 MHz
	Data Access	DPM or DMA (Direct Memory Access)
	Width for the data access to the Dual-Port Memory (DPM)	32-Bit
PROFIBUS Communication	Supported communication standard/ protocol (determined by the loaded firmware)	PROFIBUS DP Master, PROFIBUS DP Slave, PROFIBUS MPI Device
PROFIBUS Interface	Transmission rate	9,6 kBit/s, 19,2 kBit/s, 31,25 kBit/s, 45,45 kBit/s, 93,75 kBit/s, 187,5 kBit/s, 500 kBit/s, 1,5 MBit/s, 3 MBit/s, 6 MBit/s, 12 MBit/s
	Interface Type	RS 485, according EN 50170, refer to section <i>PROFIBUS Interface</i> page 107.
	Galvanic Isolation	isolated
	Isolation Voltage	1000 VDC (tested for 1 minute)
	Connector	DSub female Connector, 9 pin
Display	LED Display	<p>SYS System Status LED</p> <p>COM LED Communication Status (duo LED)</p> <p>The meaning of the COM LED depends on the loaded firmware. Refer to chapter <i>LED Descriptions</i>, page 80.</p>
Power supply	Supply Voltage	+3.3 V dc $\pm 5\%$, refer to section <i>Power Supply and Host Interface</i> , page 34.
	Maximum Current at 3.3 V (typically)	700 mA
	Connector	Via PCI Bus
Operation	Rotary Switch Slot Number (Card ID)	To set the Slot Number (Card ID)
Environmental Conditions	Operating temperature range*	-20 °C ... +70 °C (acc. to UL: 0 °C ... +55 °C)
	*Air flow during measurment	0,5m/s
	Storage temperature range	-10 °C ... +70 °C
	Humidity	10 ... 95% relative humidity, no condensation permitted
	Environment	For UL compliant usage: The device must be used in a pollution degree 2 environment.
Device	Dimensions (L x W x H)	120,0 x 86 x 18,5 mm (from hardware revision 5)
	Mounting/Installation	PCI slot (3.3 V), refer to section <i>Slot for the PC Cards cifX PCI, PCIe and Low Profile PCIe</i> , page 33.

CIFX 50-DP	Parameter	Value
	RoHS	Yes
CE Sign	CE Sign	Yes
	Emission	EN 55011:2009 + A1:2010, CISPR 11:2009, Class A (Radio disturbance characteristics - Limits and methods of measurement)
	Immunity	EN 61000-4-2:2009 (Electrostatic discharge test) EN 61000-4-3:2006 + A1:2008 + A2:2010 (Radiated, radio-frequency, electromagnetic field test) EN 61000-4-4:2004 + A1:2010 (Burst Electrical fast transients/burst test) EN 61000-4-5:2006 (Surge test) EN 61000-4-6:2009 (to conducted disturbances, induced by radio- frequency fields) EN 61000-4-8:2010 (power frequency magnetic field test) EN 61000-6-2:2005 + B1:2011 (for industrial environments)
UL Certification	The device CIFX 50-DP is certified according to UL 508.	UL-File-Nr. E221530
Configuration	Configuration Software Master and Slave	SYCON.net
	Configuration Software Slave	netX Configuration Tool

Table 97: Technical Data CIFX 50-DP

10.1.4 CIFX 50E-DP

CIFX 50E-DP	Parameter	Value
Part	Name	CIFX 50E-DP
	Part No.	1251.410
	Description	PC Card cifX PCI Express PROFIBUS DP Master or Slave and PROFIBUS MPI Device
	Function	Communication interface with PCI Express and PROFIBUS interface
Communication Controller	Type	netX 100 processor
Integrated Memory	RAM	8 MB SDRAM
	FLASH	4 MB serial Flash EPROM
	Size of the Dual-Port Memory	64 KByte
System Interface	Bus Type	PCI Express, One Lane Port, according to [bus spec 2, Rev. 2.0] and [bus spec 3], refer to section <i>Overview</i> , page 114.
	Transmission Rate	2 GBit/s
	Data Access	DPM or DMA* (Direct Memory Access); *beginning from Hardware Revision 5
	Width for the data access to the Dual-Port Memory (DPM)	32-Bit
PROFIBUS Communication	Supported communication standard/ protocol (determined by the loaded firmware)	PROFIBUS DP Master, PROFIBUS DP Slave, PROFIBUS MPI Device
PROFIBUS Interface	Transmission rate	9,6 kBit/s, 19,2 kBit/s, 31,25 kBit/s, 45,45 kBit/s, 93,75 kBit/s, 187,5 kBit/s, 500 kBit/s, 1,5 MBit/s, 3 MBit/s, 6 MBit/s, 12 MBit/s
	Interface Type	RS 485, refer to section <i>PROFIBUS Interface</i> page 107.
	Galvanic Isolation	isolated

CIFX 50E-DP	Parameter	Value
	Isolation Voltage	1000 VDC (tested for 1 minute)
	Connector	DSub female Connector, 9 pin
Display	LED Display	SYS System Status LED COM LED Communication Status (duo LED) The meaning of the COM LED depends on the loaded firmware. Refer to chapter <i>LED Descriptions</i> , page 80.
Power supply	Supply Voltage	+3.3 V dc $\pm 5\%$, refer to section <i>Power Supply and Host Interface</i> , page 34.
	Maximum Current at 3.3 V (typically)	800 mA
	Connector	Via PCI Express Bus
Operation	Rotary Switch Slot Number (Card ID)	To set the Slot Number (Card ID)
Environmental Conditions	Operating temperature range*	-20 °C ... +70 °C (acc. to UL: 0 °C ... +55 °C)
	*Air flow during measurement	0,5m/s
	Storage temperature range	-10 °C ... +70 °C
	Humidity	10 ... 95% relative humidity, no condensation permitted
	Environment	For UL compliant usage: The device must be used in a pollution degree 2 environment.
Device	Dimensions (L x W x H)	120,0 x 86 x 18,5 mm (from hardware revision 5)
	Mounting/Installation	PCI Express x1 slot (3.3 V), refer to section <i>Slot for the PC Cards cifX PCI, PCIe and Low Profile PCIe</i> , page 33.
	RoHS	Yes
CE Sign	CE Sign	Yes
	Emission	EN 55011:2009 + A1:2010, CISPR 11:2009, Class A (Radio disturbance characteristics - Limits and methods of measurement)
	Immunity	EN 61000-4-2:2009 (Electrostatic discharge test) EN 61000-4-3:2006 + A1:2008 + A2:2010 (Radiated, radio-frequency, electromagnetic field test) EN 61000-4-4:2004 + A1:2010 (Burst Electrical fast transients/burst test) EN 61000-4-5:2006 (Surge test) EN 61000-4-6:2009 (to conducted disturbances, induced by radio- frequency fields) EN 61000-4-8:2010 (power frequency magnetic field test) EN 61000-6-2:2005 + B1:2011 (for industrial environments)
UL Certification	The device CIFX 50E-DP is certified according to UL 508.	UL-File-Nr. E221530
Configuration	Configuration Software Master and Slave	SYCON.net
	Configuration Software Slave	netX Configuration Tool

Table 98: Technical Data CIFX 50E-DP

10.1.5 CIFX 50-CO

CIFX 50-CO	Parameter	Value
Part	Name	CIFX 50-CO
	Part No.	1250.500
	Description	PC Card cifX PCI CANopen Master or Slave
	Function	Communication interface with PCI and CANopen interface
Communication Controller	Type	netX 100 processor
Integrated Memory	RAM	8 MB SDRAM
	FLASH	4 MB serial Flash EPROM
	Size of the Dual-Port Memory	64 KByte
System Interface	Bus Type	PCI, according to [bus spec 1], refer to section <i>Overview</i> , page 114.
	Transmission Rate	33 MHz
	Data Access	DPM or DMA (Direct Memory Access)
	Width for the data access to the Dual-Port Memory (DPM)	32-Bit
CANopen Communication	Supported communication standard/ protocol (determined by the loaded firmware)	CANopen Master, CANopen Slave
CANopen Interface	Transmission rate	10 kBit/s, 20 kBit/s, 50 kBit/s, 100 kBit/s, 125 kBit/s, 250 kBit/s, 500 kBit/s, 800 kBit/s, 1 MBit/s
	Interface Type	ISO-11898, refer to section <i>CANopen Interface</i> , page 107.
	Galvanic Isolation	optically isolated
	Isolation Voltage	1000 VDC (tested for 1 minute)
	Connector	DSub male Connector, 9 pin
Display	LED Display	<p>SYS System Status LED</p> <p>CAN CANopen Status (duo LED)</p> <p>The meaning of the CAN LED depends on the loaded firmware. Refer to chapter <i>LED Descriptions</i>, page 80.</p>
Power supply	Supply Voltage	+3.3 V dc ±5 %, refer to section <i>Power Supply and Host Interface</i> , page 34.
	Maximum Current at 3.3 V (typically)	650 mA
	Connector	Via PCI Bus
Operation	Rotary Switch Slot Number (Card ID)	To set the Slot Number (Card ID)
Environmental Conditions	Operating temperature range*	-20 °C ... +70 °C (acc. to UL: 0 °C ... +55 °C)
	*Air flow during measurement	0,5m/s
	Storage temperature range	-10 °C ... +70 °C
	Humidity	10 ... 95% relative humidity, no condensation permitted
	Environment	For UL compliant usage: The device must be used in a pollution degree 2 environment.
Device	Dimensions (L x W x H)	120,0 x 86 x 18,5 mm (from hardware revision 5)
	Mounting/Installation	PCI slot (3.3 V), refer to section <i>Slot for the PC Cards cifX PCI, PCIe and Low Profile PCIe</i> , page 33.
	RoHS	Yes
CE Sign	CE Sign	Yes

CIFX 50-CO	Parameter	Value
	Emission	EN 55011:2009 + A1:2010, CISPR 11:2009, Class A (Radio disturbance characteristics - Limits and methods of measurement)
	Immunity	EN 61000-4-2:2009 (Electrostatic discharge test) EN 61000-4-3:2006 + A1:2008 + A2:2010 (Radiated, radio-frequency, electromagnetic field test) EN 61000-4-4:2004 + A1:2010 (Burst Electrical fast transients/burst test) EN 61000-4-5:2006 (Surge test) EN 61000-4-6:2009 (to conducted disturbances, induced by radio- frequency fields) EN 61000-4-8:2010 (power frequency magnetic field test) EN 61000-6-2:2005 + B1:2011 (for industrial environments)
UL Certification	The device CIFX 50-CO is certified according to UL 508.	UL-File-Nr. E221530
Configuration	Configuration Software Master and Slave	SYCON.net
	Configuration Software Slave	netX Configuration Tool

Table 99: Technical Data CIFX 50-CO

10.1.6 CIFX 50E-CO

CIFX 50E-CO	Parameter	Value
Part	Name	CIFX 50E-CO
	Part No.	1251.500
	Description	PC Card cifX PCI ExpressCANopen Master or Slave
	Function	Communication interface with PCI Express and CANopen interface
Communication Controller	Type	netX 100 processor
Integrated Memory	RAM	8 MB SDRAM
	FLASH	4 MB serial Flash EPROM
	Size of the Dual-Port Memory	64 KByte
System Interface	Bus Type	PCI Express, One Lane Port, according to [bus spec 2, Rev. 2.0] and [bus spec 3], refer to section <i>Overview</i> , page 114.
	Transmission Rate	2 GBit/s
	Data Access	DPM or DMA* (Direct Memory Access); *beginning from Hardware Revision 4
	Width for the data access to the Dual-Port Memory (DPM)	32-Bit
CANopen Communication	Supported communication standard/ protocol (determined by the loaded firmware)	CANopen Master, CANopen Slave
CANopen Interface	Transmission rate	10 kBit/s, 20 kBit/s, 50 kBit/s, 100 kBit/s, 125 kBit/s, 250 kBit/s, 500 kBit/s, 800 kBit/s, 1 MBit/s
	Interface Type	ISO-11898, refer to section <i>CANopen Interface</i> , page 107.
	Galvanic Isolation	optically isolated
	Isolation Voltage	1000 VDC (tested for 1 minute)
	Connector	DSub male Connector, 9 pin

CIFX 50E-CO	Parameter	Value
Display	LED Display	SYS System Status LED CAN CANopen Status (duo LED) The meaning of the CAN LED depends on the loaded firmware. Refer to chapter <i>LED Descriptions</i> , page 80.
Power supply	Supply Voltage	+3.3 V dc $\pm 5\%$, refer to section <i>Power Supply and Host Interface</i> , page 34.
	Maximum Current at 3.3 V (typically)	800 mA
	Connector	Via PCI Express Bus
Operation	Rotary Switch Slot Number (Card ID)	To set the Slot Number (Card ID)
Environmental Conditions	Operating temperature range*	-20 °C ... +70 °C (acc. to UL: 0 °C ... +55 °C)
	*Air flow during measurement	0,5m/s
	Storage temperature range	-10 °C ... +70 °C
	Humidity	10 ... 95% relative humidity, no condensation permitted
	Environment	For UL compliant usage: The device must be used in a pollution degree 2 environment.
Device	Dimensions (L x W x H)	120,0 x 86 x 18,5 mm (from hardware revision 4)
	Mounting/Installation	PCI Express x1 slot (3.3 V), refer to section <i>Slot for the PC Cards cifX PCI, PCIe and Low Profile PCIe</i> , page 33.
	RoHS	Yes
CE Sign	CE Sign	Yes
	Emission	EN 55011:2009 + A1:2010, CISPR 11:2009, Class A (Radio disturbance characteristics - Limits and methods of measurement)
	Immunity	EN 61000-4-2:2009 (Electrostatic discharge test) EN 61000-4-3:2006 + A1:2008 + A2:2010 (Radiated, radio-frequency, electromagnetic field test) EN 61000-4-4:2004 + A1:2010 (Burst Electrical fast transients/burst test) EN 61000-4-5:2006 (Surge test) EN 61000-4-6:2009 (to conducted disturbances, induced by radio- frequency fields) EN 61000-4-8:2010 (power frequency magnetic field test) EN 61000-6-2:2005 + B1:2011 (for industrial environments)
UL Certification	The device CIFX 50E-CO is certified according to UL 508.	UL-File-Nr. E221530
Configuration	Configuration Software Master and Slave	SYCON.net
	Configuration Software Slave	netX Configuration Tool

Table 100: Technical Data CIFX 50E-CO

10.1.7 CIFX 50-DN

CIFX 50-DN	Parameter	Value
Part	Name	CIFX 50-DN
	Part No.	1250.510
	Description	PC Card cifX PCI DeviceNet Master or Slave
	Function	Communication interface with PCI and DeviceNet interface

CIFX 50-DN	Parameter	Value
Communication Controller	Type	netX 100 processor
Integrated Memory	RAM	8 MB SDRAM
	FLASH	4 MB serial Flash EPROM
	Size of the Dual-Port Memory	64 KByte
System Interface	Bus Type	PCI, according to [bus spec 1], refer to section <i>Overview</i> , page 114.
	Transmission Rate	33 MHz
	Data Access	DPM or DMA (Direct Memory Access)
	Width for the data access to the Dual-Port Memory (DPM)	32-Bit
DeviceNet Communication	Supported communication standard/ protocol (determined by the loaded firmware)	DeviceNet Master, DeviceNet Slave
DeviceNet Interface	Transmission rate	125 kBit/s, 250 kBit/s, 500 kBit/s
	Interface Type	ISO-11898 according to DeviceNet specification, refer to section <i>DeviceNet Interface</i> , page 108.
	Galvanic Isolation	optically isolated
	Isolation Voltage	1000 VDC (tested for 1 minute)
	Connector	CombiCon male Connector, 5 pin
Display	LED Display	<p>SYS System Status LED</p> <p>MNS Module Network Status (duo LED)</p> <p>The meaning of the MNS LED depends on the loaded firmware. Refer to chapter <i>LED Descriptions</i>, page 80.</p>
Power supply	Supply Voltage	+3.3 V dc $\pm 5\%$, refer to section <i>Power Supply and Host Interface</i> , page 34.
	Maximum Current at 3.3 V (typically)	650 mA
	Connector	Via PCI Bus
Operation	Rotary Switch Slot Number (Card ID)	To set the Slot Number (Card ID)
Environmental Conditions	Operating temperature range*	-20 °C ... +70 °C (acc. to UL: 0 °C ... +55 °C)
	*Air flow during measurement	0,5m/s
	Storage temperature range	-10 °C ... +70 °C
	Humidity	10 ... 95% relative humidity, no condensation permitted
	Environment	For UL compliant usage: The device must be used in a pollution degree 2 environment.
Device	Dimensions (L x W x H)	120,0 x 86 x 18,5 mm (from hardware revision 5)
	Mounting/Installation	PCI slot (3.3 V), refer to section <i>Slot for the PC Cards cifX PCI, PCIe and Low Profile PCIe</i> , page 33.
	RoHS	Yes
CE Sign	CE Sign	Yes
	Emission	EN 55011:2009 + A1:2010, CISPR 11:2009, Class A (Radio disturbance characteristics - Limits and methods of measurement)
	Immunity	EN 61000-4-2:2009 (Electrostatic discharge test) EN 61000-4-3:2006 + A1:2008 + A2:2010 (Radiated, radio-frequency, electromagnetic field test) EN 61000-4-4:2004 + A1:2010 (Burst Electrical fast transients/burst test)

CIFX 50-DN	Parameter	Value
		EN 61000-4-5:2006 (Surge test) EN 61000-4-6:2009 (to conducted disturbances, induced by radio- frequency fields) EN 61000-4-8:2010 (power frequency magnetic field test) EN 61000-6-2:2005 + B1:2011 (for industrial environments)
UL Certification	The device CIFX 50-DN is certified according to UL 508.	UL-File-Nr. E221530
Configuration	Configuration Software Master and Slave	SYCON.net
	Configuration Software Slave	netX Configuration Tool

Table 101: Technical Data CIFX 50-DN

10.1.8 CIFX 50E-DN

CIFX 50E-DN	Parameter	Value
Part	Name	CIFX 50E-DN
	Part No.	1251.510
	Description	PC Card cifX PCI ExpressDeviceNet Master or Slave
	Function	Communication interface with PCI Express and DeviceNet interface
Communication Controller	Type	netX 100 processor
Integrated Memory	RAM	8 MB SDRAM
	FLASH	4 MB serial Flash EPROM
	Size of the Dual-Port Memory	64 KByte
System Interface	Bus Type	PCI Express, One Lane Port, according to [bus spec 2, Rev. 2.0] and [bus spec 3], refer to section <i>Overview</i> , page 114.
	Transmission Rate	2 GBit/s
	Data Access	DPM or DMA* (Direct Memory Access); *beginning from Hardware Revision 4
	Width for the data access to the Dual-Port Memory (DPM)	32-Bit
DeviceNet Communication	Supported communication standard/ protocol (determined by the loaded firmware)	DeviceNet Master, DeviceNet Slave
DeviceNet Interface	Transmission rate	125 kBit/s, 250 kBit/s, 500 kBit/s
	Interface Type	ISO-11898 according to DeviceNet specification, refer to section <i>DeviceNet Interface</i> , page 108.
	Galvanic Isolation	optically isolated
	Isolation Voltage	1000 VDC (tested for 1 minute)
	Connector	CombiCon male Connector, 5 pin
Display	LED Display	SYS System Status LED MNS Module Network Status (duo LED) The meaning of the MNS LED depends on the loaded firmware. Refer to chapter <i>LED Descriptions</i> , page 80..
Power supply	Supply Voltage	+3.3 V dc $\pm 5\%$, refer to section <i>Power Supply and Host Interface</i> , page 34.
	Maximum Current at 3.3 V (typically)	800 mA
	Connector	Via PCI Express Bus

CIFX 50E-DN	Parameter	Value
Operation	Rotary Switch Slot Number (Card ID)	To set the Slot Number (Card ID)
Environmental Conditions	Operating temperature range*	-20 °C ... +70 °C (acc. to UL: 0 °C ... +55 °C)
	*Air flow during measurement	0,5m/s
	Storage temperature range	-10 °C ... +70 °C
	Humidity	10 ... 95% relative humidity, no condensation permitted
	Environment	For UL compliant usage: The device must be used in a pollution degree 2 environment.
Device	Dimensions (L x W x H)	120,0 x 86 x 18,5 mm (from hardware revision 4)
	Mounting/Installation	PCI Express x1 slot (3.3 V), refer to section <i>Slot for the PC Cards cifX PCI, PCIe and Low Profile PCIe</i> , page 33.
	RoHS	Yes
CE Sign	CE Sign	Yes
	Emission	EN 55011:2009 + A1:2010, CISPR 11:2009, Class A (Radio disturbance characteristics - Limits and methods of measurement)
	Immunity	EN 61000-4-2:2009 (Electrostatic discharge test) EN 61000-4-3:2006 + A1:2008 + A2:2010 (Radiated, radio-frequency, electromagnetic field test) EN 61000-4-4:2004 + A1:2010 (Burst Electrical fast transients/burst test) EN 61000-4-5:2006 (Surge test) EN 61000-4-6:2009 (to conducted disturbances, induced by radio- frequency fields) EN 61000-4-8:2010 (power frequency magnetic field test) EN 61000-6-2:2005 + B1:2011 (for industrial environments)
UL Certification	The device CIFX 50E-DN is certified according to UL 508.	UL-File-Nr. E221530
Configuration	Configuration Software Master and Slave	SYCON.net
	Configuration Software Slave	netX Configuration Tool

Table 102: Technical Data CIFX 50E-DN

10.1.9 CIFX 50-CC

CIFX 50-CC	Parameter	Value
Part	Name	CIFX 50-CC
	Part No.	1250.740
	Description	PC Card cifX PCI CC-Link Slave
	Function	Communication interface with PCI and CC-Link interface
Communication Controller	Type	netX 100 processor
Integrated Memory	RAM	8 MB SDRAM
	FLASH	4 MB serial Flash EPROM
	Size of the Dual-Port Memory	64 KByte
System Interface	Bus Type	PCI, according to [bus spec 1], refer to section <i>Overview</i> , page 114.
	Transmission Rate	33 MHz
	Data Access	DPM or DMA (Direct Memory Access)

CIFX 50-CC	Parameter	Value
	Width for the data access to the Dual-Port Memory (DPM)	32-Bit
CC-Link Communication	Supported communication standard/ protocol (determined by the loaded firmware)	CC-Link Slave
CC-Link Interface	Transmission rate	156 kBit/s, 625 kBit/s, 2500 kBit/s, 5 MBit/s, 10 MBit/s
	Interface Type	RS-485, refer to section <i>CC-Link Interface</i> , page 109.
	Galvanic Isolation	optically isolated
	Isolation Voltage	1000 VDC (tested for 1 minute)
	Connector	CombiCon male Connector, 5 pin
Display	LED Display	SYS System Status LED L RUN LED L Run (Duo LED) L ERR LED L Error (Duo LED) Refer to chapter <i>LED Descriptions</i> , page 80.
Power supply	Supply Voltage	+3.3 V dc $\pm 5\%$, refer to section <i>Power Supply and Host Interface</i> , page 34.
	Maximum Current at 3.3 V (typically)	650 mA
	Connector	Via PCI Bus
Operation	Rotary Switch Slot Number (Card ID)	To set the Slot Number (Card ID)
Environmental Conditions	Operating temperature range*	-20 °C ... +55 °C
	*Air flow during measurment	0,5m/s
	Storage temperature range	-10 °C ... +70 °C
	Humidity	10 ... 95% relative humidity, no condensation permitted
	Environment	For UL compliant usage: The device must be used in a pollution degree 2 environment.
Device	Dimensions (L x W x H)	120 x 85,4 x 18,5 mm (from hardware revision 2)
	Mounting/Installation	PCI slot (3.3 V), refer to section <i>Slot for the PC Cards cifX PCI, PCIe and Low Profile PCIe</i> , page 33.
	RoHS	Yes
CE Sign	CE Sign	Yes
	Emission	EN 55011:2009 + A1:2010, CISPR 11:2009, Class A (Radio disturbance characteristics - Limits and methods of measurement)
	Immunity	EN 61000-4-2:2009 (Electrostatic discharge test) EN 61000-4-3:2006 + A1:2008 + A2:2010 (Radiated, radio-frequency, electromagnetic field test) EN 61000-4-4:2004 + A1:2010 (Burst Electrical fast transients/burst test) EN 61000-4-5:2006 (Surge test) EN 61000-4-6:2009 (to conducted disturbances, induced by radio- frequency fields) EN 61000-4-8:2010 (power frequency magnetic field test) EN 61000-6-2:2005 + B1:2011 (for industrial environments)
UL Certification	The device CIFX 50-CC is certified according to UL 508.	UL-File-Nr. E221530
Configuration	Configuration Software	SYCON.net or netX Configuration Tool

Table 103: Technical Data CIFX 50-CC

10.1.10 CIFX 50E-CC

CIFX 50E-CC	Parameter	Value
Part	Name	CIFX 50E-CC
	Part No.	1251.740
	Description	PC Card cifX PCI ExpressCC-Link Slave
	Function	Communication interface with PCI Express and CC-Link interface
Communication Controller	Type	netX 100 processor
Integrated Memory	RAM	8 MB SDRAM
	FLASH	4 MB serial Flash EPROM
	Size of the Dual-Port Memory	64 KByte
System Interface	Bus Type	PCI Express, One Lane Port, according to [bus spec 2, Rev. 2.0] and [bus spec 3], refer to section <i>Overview</i> , page 114.
	Transmission Rate	2 GBit/s
	Data Access	DPM or DMA* (Direct Memory Access); *beginning from Hardware Revision 3
	Width for the data access to the Dual-Port Memory (DPM)	32-Bit
CC-Link Communication	Supported communication standard/ protocol (determined by the loaded firmware)	CC-Link Slave
CC-Link Interface	Transmission rate	156 kBit/s, 625 kBit/s, 2500 kBit/s, 5 MBit/s, 10 MBit/s
	Interface Type	RS-485, refer to section <i>CC-Link Interface</i> , page 109.
	Galvanic Isolation	optically isolated
	Isolation Voltage	1000 VDC (tested for 1 minute)
	Connector	CombiCon male Connector, 5 pin
Display	LED Display	SYS System Status LED L RUN LED L Run (Duo LED) L ERR LED L Error (Duo LED) Refer to chapter <i>LED Descriptions</i> , page 80.
Power supply	Supply Voltage	+3.3 V dc $\pm 5\%$, refer to section <i>Power Supply and Host Interface</i> , page 34.
	Maximum Current at 3.3 V (typically)	800 mA
	Connector	Via PCI Express Bus
Operation	Rotary Switch Slot Number (Card ID)	To set the Slot Number (Card ID)
Environmental Conditions	Operating temperature range*	0 °C ... +60 °C (acc. to UL: 0 °C ... +55 °C)
	*Air flow during measurement	0,5m/s
	Storage temperature range	0 °C ... +70 °C
	Humidity	10 ... 95% relative humidity, no condensation permitted
	Environment	For UL compliant usage: The device must be used in a pollution degree 2 environment.
Device	Dimensions (L x W x H)	120 x 89,9 x 18,5 mm (from hardware revision 3)
	Mounting/Installation	PCI Express x1 slot (3.3 V), refer to section <i>Slot for the PC Cards cifX PCI, PCIe and Low Profile PCIe</i> , page 33.
	RoHS	Yes

CIFX 50E-CC	Parameter	Value
CE Sign	CE Sign	Yes
	Emission	EN 55011:2009 + A1:2010, CISPR 11:2009, Class A (Radio disturbance characteristics - Limits and methods of measurement)
	Immunity	EN 61000-4-2:2009 (Electrostatic discharge test) EN 61000-4-3:2006 + A1:2008 + A2:2010 (Radiated, radio-frequency, electromagnetic field test) EN 61000-4-4:2004 + A1:2010 (Burst Electrical fast transients/burst test) EN 61000-4-5:2006 (Surge test) EN 61000-4-6:2009 (to conducted disturbances, induced by radio- frequency fields) EN 61000-4-8:2010 (power frequency magnetic field test) EN 61000-6-2:2005 + B1:2011 (for industrial environments)
UL Certification	The device CIFX 50E-CC is certified according to UL 508.	UL-File-Nr. E221530
Configuration	Configuration Software	SYCON.net or netX Configuration Tool

Table 104: Technical Data CIFX 50E-CC

10.1.11 CIFX 50-2DP

CIFX 50-2DP	Parameter	Value
Part	Name	CIFX 50-2DP
	Part No.	1252.410
	Description	PC Card cifX PCI 2 channel PROFIBUS DP Master or Slave
	Function	Communication interface with PCI and 2 x PROFIBUS interface
Communication Controller	Type	netX 100 processor
Integrated Memory	RAM	8 MB SDRAM
	FLASH	4 MB serial Flash EPROM
	Size of the Dual-Port Memory	64 KByte
System Interface	Bus Type	PCI, according to [bus spec 1], refer to section <i>Overview</i> , page 114.
	Transmission Rate	33 MHz
	Data Access	DPM or DMA (Direct Memory Access)
	Width for the data access to the Dual-Port Memory (DPM)	32-Bit
PROFIBUS Communication	Supported communication standard/ protocol (determined by the loaded firmware)	PROFIBUS DP Master, PROFIBUS DP Slave
PROFIBUS Interface	Transmission rate	9,6 kBit/s, 19,2 kBit/s, 31,25 kBit/s, 45,45 kBit/s, 93,75 kBit/s, 187,5 kBit/s, 500 kBit/s, 1,5 MBit/s, 3 MBit/s, 6 MBit/s, 12 MBit/s
	Interface Type	2 * RS 485, refer to section <i>PROFIBUS Interface</i> p. 107.
	Galvanic Isolation	isolated
	Isolation Voltage	1000 VDC (tested for 1 minute)
	Connector	DSub female Connector, 9 pin

CIFX 50-2DP	Parameter	Value
Display	LED Display	<p>SYS System Status LED</p> <p>COM 0 LED Communication Status 0 (duo LED) for channel X1</p> <p>COM 1 LED Communication Status 1 (duo LED) for channel X2</p> <p>The meaning of the LEDs COM0 and COM1 depends on the loaded firmware. Refer to ch. <i>LED Descriptions</i>, p. 80.</p>
Power supply	Supply Voltage	+3.3 V dc \pm 5 %, refer to section <i>Power Supply and Host Interface</i> , page 34.
	Maximum Current at 3.3 V (typically)	700 mA
	Connector	Via PCI Bus
Operation	Rotary Switch Slot Number (Card ID)	To set the Slot Number (Card ID)
Environmental Conditions	Operating temperature range*	-20 °C ... +70 °C (acc. to UL: 0 °C ... +55 °C)
	*Air flow during measurement	0,5m/s
	Storage temperature range	-10 °C ... +70 °C
	Humidity	10 ... 95% relative humidity, no condensation permitted
	Environment	For UL compliant usage: The device must be used in a pollution degree 2 environment.
Device	Dimensions (L x W x H)	120 x 94,5 x 18,5 mm
	Mounting/Installation	PCI slot (3.3 V), refer to section <i>Slot for the PC Cards cifX PCI, PCIe and Low Profile PCIe</i> , page 33.
	RoHS	Yes
CE Sign	CE Sign	Yes
	Emission	EN 55011:2009 + A1:2010, CISPR 11:2009, Class A (Radio disturbance characteristics - Limits and methods of measurement)
	Immunity	<p>EN 61000-4-2:2009 (Electrostatic discharge test)</p> <p>EN 61000-4-3:2006 + A1:2008 + A2:2010 (Radiated, radio-frequency, electromagnetic field test)</p> <p>EN 61000-4-4:2004 + A1:2010 (Burst Electrical fast transients/burst test)</p> <p>EN 61000-4-5:2006 (Surge test)</p> <p>EN 61000-4-6:2009 (to conducted disturbances, induced by radio- frequency fields)</p> <p>EN 61000-4-8:2010 (power frequency magnetic field test)</p> <p>EN 61000-6-2:2005 + B1:2011 (for industrial environments)</p>
UL Certification	The device CIFX 50-2DP is certified according to UL 508.	UL-File-Nr. E221530
Configuration	Configuration Software Master	SYCON.net

Table 105: Technical Data CIFX 50-2DP

10.1.12 CIFX 50-2DP\CO

CIFX 50-2DP\CO	Parameter	Value
Part	Name	CIFX 50-2DP\CO
	Part No.	1252.470
	Description	PC Card cifX PCI 2 channel - Channel X0: PROFIBUS DP Master or Slave, Channel X1: CANopen Master or Slave
	Function	Communication interface with PCI, 1 x PROFIBUS and 1 x CANopen interface
Communication Controller	Type	netX 100 processor
Integrated Memory	RAM	8 MB SDRAM
	FLASH	4 MB serial Flash EPROM
	Size of the Dual-Port Memory	64 KByte
System Interface	Bus Type	PCI, according to [bus spec 1], refer to section <i>Overview</i> , page 114.
	Transmission Rate	33 MHz
	Data Access	DPM or DMA (Direct Memory Access)
	Width for the data access to the Dual-Port Memory (DPM)	32-Bit
PROFIBUS Communication	Supported communication standard/ protocol (determined by the loaded firmware)	PROFIBUS DP Master, PROFIBUS DP Slave
PROFIBUS Interface	Transmission rate	9,6 kBit/s, 19,2 kBit/s, 31,25 kBit/s, 45,45 kBit/s, 93,75 kBit/s, 187,5 kBit/s, 500 kBit/s, 1,5 MBit/s, 3 MBit/s, 6 MBit/s, 12 MBit/s
	Interface Type	2 * RS 485, refer to section <i>PROFIBUS Interface</i> p. 107.
	Galvanic Isolation	isolated
	Isolation Voltage	1000 VDC (tested for 1 minute)
	Connector	DSub female Connector, 9 pin
CANopen Communication	Supported communication standard/ protocol (determined by the loaded firmware)	CANopen Master, CANopen Slave
CANopen Interface	Transmission rate	10 kBit/s, 20 kBit/s, 50 kBit/s, 100 kBit/s, 125 kBit/s, 250 kBit/s, 500 kBit/s, 800 kBit/s, 1 MBit/s
	Interface Type	ISO-11898, refer to section <i>CANopen Interface</i> , page 107.
	Galvanic Isolation	optically isolated
	Isolation Voltage	1000 VDC (tested for 1 minute)
	Connector	DSub male Connector, 9 pin
Display	LED Display	SYS System Status LED COM 0 LED Communication Status 0 (duo LED) for channel X1 CAN 1 CANopen Status 1 (duo LED) for channel X2 The meaning of the LEDs COM0 and CAN1 depends on the loaded firmware. Refer to chapter <i>LED Descriptions</i> , page 80.
Power supply	Supply Voltage	+3.3 V dc \pm 5 %, refer to section <i>Power Supply and Host Interface</i> , page 34.
	Maximum Current at 3.3 V (typically)	700 mA
	Connector	Via PCI Bus
Operation	Rotary Switch Slot Number (Card ID)	To set the Slot Number (Card ID)

CIFX 50-2DP\CO	Parameter	Value
Environmental Conditions	Operating temperature range*	-20 °C ... +70°C
	*Air flow during measurement	0,5m/s
	Storage temperature range	-10 °C ... +70 °C
	Humidity	10 ... 95% relative humidity, no condensation permitted
Device	Dimensions (L x W x H)	120 x 94,5 x 18,5 mm
	Mounting/Installation	PCI slot (3.3 V), refer to section <i>Slot for the PC Cards cifX PCI, PCIe and Low Profile PCIe</i> , page 33.
	RoHS	Yes
CE Sign	CE Sign	Yes
	Emission	EN 55011:2009 + A1:2010, CISPR 11:2009, Class A (Radio disturbance characteristics - Limits and methods of measurement)
	Immunity	EN 61000-4-2:2009 (Electrostatic discharge test) EN 61000-4-3:2006 + A1:2008 + A2:2010 (Radiated, radio-frequency, electromagnetic field test) EN 61000-4-4:2004 + A1:2010 (Burst Electrical fast transients/burst test) EN 61000-4-5:2006 (Surge test) EN 61000-4-6:2009 (to conducted disturbances, induced by radio- frequency fields) EN 61000-4-8:2010 (power frequency magnetic field test) EN 61000-6-2:2005 + B1:2011 (for industrial environments)
Configuration	Configuration Software Master	SYCON.net

Table 106: Technical Data CIFX 50-2DP\CO

10.1.13 CIFX 50-2DP\DN

CIFX 50-2DP\DN	Parameter	Value
Part	Name	CIFX 50-2DP\DN
	Part No.	1252.480
	Description	PC Card cifX PCI 2 channel - Channel X0: PROFIBUS DP Master or Slave, Channel X1: DeviceNet Master or Slave
	Function	Communication interface with PCI, 1 x PROFIBUS and 1 x DeviceNet interface
Communication Controller	Type	netX 100 processor
Integrated Memory	RAM	8 MB SDRAM
	FLASH	4 MB serial Flash EPROM
	Size of the Dual-Port Memory	64 KByte
System Interface	Bus Type	PCI, according to [bus spec 1], refer to section <i>Overview</i> , page 114.
	Transmission Rate	33 MHz
	Data Access	DPM or DMA (Direct Memory Access)
	Width for the data access to the Dual-Port Memory (DPM)	32-Bit
PROFIBUS Communication	Supported communication standard/ protocol (determined by the loaded firmware)	PROFIBUS DP Master, PROFIBUS DP Slave
PROFIBUS Interface	Transmission rate	9,6 kBit/s, 19,2 kBit/s, 31,25 kBit/s, 45,45 kBit/s, 93,75 kBit/s, 187,5 kBit/s, 500 kBit/s, 1,5 MBit/s, 3 MBit/s,

CIFX 50-2DP\DN	Parameter	Value
		6 MBit/s, 12 MBit/s
	Interface Type	2 * RS 485, refer to section <i>PROFIBUS Interface</i> p. 107.
	Galvanic Isolation	isolated
	Isolation Voltage	1000 VDC (tested for 1 minute)
	Connector	DSub female Connector, 9 pin
DeviceNet Communication	Supported communication standard/ protocol (determined by the loaded firmware)	DeviceNet Master, DeviceNet Slave
DeviceNet Interface	Transmission rate	125 kBit/s, 250 kBit/s, 500 kBit/s
	Interface Type	ISO-11898 according to DeviceNet specification, refer to section <i>DeviceNet Interface</i> , page 108.
	Galvanic Isolation	optically isolated
	Isolation Voltage	1000 VDC (tested for 1 minute)
	Connector	CombiCon male Connector, 5 pin
Display	LED Display	<p>SYS System Status LED</p> <p>COM 0 LED Communication Status 0 (duo LED) for channel X1</p> <p>MNS 1 DeviceNet-Status 1 (duo LED) for channel X2</p> <p>The meaning of the LEDs COM0 and MNS1 depends on the loaded firmware. Refer to chapter <i>LED Descriptions</i>, page 80.</p>
Power supply	Supply Voltage	+3.3 V dc \pm 5 %, refer to section <i>Power Supply and Host Interface</i> , page 34.
	Maximum Current at 3.3 V (typically)	700 mA
	Connector	Via PCI Bus
Operation	Rotary Switch Slot Number (Card ID)	To set the Slot Number (Card ID)
Environmental Conditions	Operating temperature range*	-20 °C ... +70 °C
	*Air flow during measurement	0,5m/s
	Storage temperature range	-10 °C ... +70 °C
	Humidity	10 ... 95% relative humidity, no condensation permitted
Device	Dimensions (L x W x H)	120 x 94,5 x 18,5 mm
	Mounting/Installation	PCI slot (3.3 V), refer to section <i>Slot for the PC Cards cifX PCI, PCIe and Low Profile PCIe</i> , page 33.
	RoHS	Yes
CE Sign	CE Sign	Yes
	Emission	EN 55011:2009 + A1:2010, CISPR 11:2009, Class A (Radio disturbance characteristics - Limits and methods of measurement)
	Immunity	EN 61000-4-2:2009 (Electrostatic discharge test) EN 61000-4-3:2006 + A1:2008 + A2:2010 (Radiated, radio-frequency, electromagnetic field test) EN 61000-4-4:2004 + A1:2010 (Burst Electrical fast transients/burst test) EN 61000-4-5:2006 (Surge test) EN 61000-4-6:2009 (to conducted disturbances, induced by radio- frequency fields) EN 61000-4-8:2010 (power frequency magnetic field test) EN 61000-6-2:2005 + B1:2011 (for industrial environments)

CIFX 50-2DP\DN	Parameter	Value
Configuration	Configuration Software Master	SYCON.net

Table 107: Technical Data CIFX 50-2DP\DN

10.1.14 CIFX 50-2CO

CIFX 50-2CO	Parameter	Value
Part	Name	CIFX 50-2CO
	Part No.	1252.500
	Description	PC Card cifX PCI 2 channel CANopen Master or Slave
	Function	Communication interface with PCI and 2 x CANopen interface
Communication Controller	Type	netX 100 processor
Integrated Memory	RAM	8 MB SDRAM
	FLASH	4 MB serial Flash EPROM
	Size of the Dual-Port Memory	64 KByte
System Interface	Bus Type	PCI, according to [bus spec 1], refer to section <i>Overview</i> , page 114.
	Transmission Rate	33 MHz
	Data Access	DPM or DMA (Direct Memory Access)
	Width for the data access to the Dual-Port Memory (DPM)	32-Bit
CANopen Communication	Supported communication standard/ protocol (determined by the loaded firmware)	CANopen Master, CANopen Slave
CANopen Interface	Transmission rate	10 kBit/s, 20 kBit/s, 50 kBit/s, 100 kBit/s, 125 kBit/s, 250 kBit/s, 500 kBit/s, 800 kBit/s, 1 MBit/s
	Interface Type	ISO-11898, refer to section <i>CANopen Interface</i> , page 107.
	Galvanic Isolation	optically isolated
	Isolation Voltage	1000 VDC (tested for 1 minute)
	Connector	DSub male Connector, 9 pin
Display	LED Display	<p>SYS System Status LED</p> <p>CAN 0 CANopen Status 0 (duo LED) for channel X1</p> <p>CAN 1 CANopen Status 1 (duo LED) for channel X2</p> <p>The meaning of the LEDs CAN0 and CAN1 depends on the loaded firmware. Refer to chapter <i>LED Descriptions</i>, page 80.</p>
Power supply	Supply Voltage	+3.3 V dc $\pm 5\%$, refer to section <i>Power Supply and Host Interface</i> , page 34.
	Maximum Current at 3.3 V (typically)	700 mA
	Connector	Via PCI Bus
Operation	Rotary Switch Slot Number (Card ID)	To set the Slot Number (Card ID)
Environmental Conditions	Operating temperature range*	-20 °C ... +70 °C
	*Air flow during measurement	0,5m/s
	Storage temperature range	-10 °C ... +70 °C
	Humidity	10 ... 95% relative humidity, no condensation permitted
Device	Dimensions (L x W x H)	120 x 94,5 x 18,5 mm
	Mounting/Installation	PCI slot (3.3 V), refer to section <i>Slot for the PC Cards cifX</i>

CIFX 50-2CO	Parameter	Value
		PCI, PCIe and Low Profile PCIe, page 33.
	RoHS	Yes
CE Sign	CE Sign	Yes
	Emission	EN 55011:2009 + A1:2010, CISPR 11:2009, Class A (Radio disturbance characteristics - Limits and methods of measurement)
	Immunity	EN 61000-4-2:2009 (Electrostatic discharge test) EN 61000-4-3:2006 + A1:2008 + A2:2010 (Radiated, radio-frequency, electromagnetic field test) EN 61000-4-4:2004 + A1:2010 (Burst Electrical fast transients/burst test) EN 61000-4-5:2006 (Surge test) EN 61000-4-6:2009 (to conducted disturbances, induced by radio- frequency fields) EN 61000-4-8:2010 (power frequency magnetic field test) EN 61000-6-2:2005 + B1:2011 (for industrial environments)
Configuration	Configuration Software Master	SYCON.net

Table 108: Technical Data CIFX 50-2CO

10.1.15 CIFX 50-2CO\DN

CIFX 50-2CO\DN	Parameter	Value
Part	Name	CIFX 50-2CO\DN
	Part No.	1252.570
	Description	PC Card cifX PCI 2 channel - Channel X0: CANopen Master or Slave, Channel X1: DeviceNet Master or Slave
	Function	Communication interface with PCI, 1 x CANopen and 1 x DeviceNet interface
Communication Controller	Type	netX 100 processor
Integrated Memory	RAM	8 MB SDRAM
	FLASH	4 MB serial Flash EPROM
	Size of the Dual-Port Memory	64 KByte
System Interface	Bus Type	PCI, according to [bus spec 1], refer to section <i>Overview</i> , page 114.
	Transmission Rate	33 MHz
	Data Access	DPM or DMA (Direct Memory Access)
	Width for the data access to the Dual-Port Memory (DPM)	32-Bit
CANopen Communication	Supported communication standard/ protocol (determined by the loaded firmware)	CANopen Master, CANopen Slave
CANopen Interface	Transmission rate	10 kBit/s, 20 kBit/s, 50 kBit/s, 100 kBit/s, 125 kBit/s, 250 kBit/s, 500 kBit/s, 800 kBit/s, 1 MBit/s
	Interface Type	ISO-11898, refer to section <i>CANopen Interface</i> , page 107.
	Galvanic Isolation	optically isolated
	Isolation Voltage	1000 VDC (tested for 1 minute)
	Connector	DSub male Connector, 9 pin
DeviceNet Communication	Supported communication standard/ protocol (determined by)	DeviceNet Master, DeviceNet Slave

CIFX 50-2CO\DN	Parameter	Value
	the loaded firmware)	
DeviceNet Interface	Transmission rate	125 kBit/s, 250 kBit/s, 500 kBit/s
	Interface Type	ISO-11898 according to DeviceNet specification, refer to section <i>DeviceNet Interface</i> , page 108.
	Galvanic Isolation	optically isolated
	Isolation Voltage	1000 VDC (tested for 1 minute)
	Connector	CombiCon male Connector, 5 pin
Display	LED Display	SYS System Status LED CAN 0 CANOpen Status 0 (duo LED) for channel X1 MNS 1 CANOpen Status 1 (duo LED) for channel X2 The meaning of the LEDs CAN0 and MNS1 depends on the loaded firmware. Refer to chapter <i>LED Descriptions</i> , page 80.
Power supply	Supply Voltage	+3.3 V dc $\pm 5\%$, refer to section <i>Power Supply and Host Interface</i> , page 34.
	Maximum Current at 3.3 V (typically)	700 mA
	Connector	Via PCI Bus
Operation	Rotary Switch Slot Number (Card ID)	To set the Slot Number (Card ID)
Environmental Conditions	Operating temperature range*	-20 °C ... +70 °C
	*Air flow during measurement	0,5m/s
	Storage temperature range	-10 °C ... +70 °C
	Humidity	10 ... 95% relative humidity, no condensation permitted
Device	Dimensions (L x W x H)	120 x 94,5 x 18,5 mm
	Mounting/Installation	PCI slot (3.3 V), refer to section <i>Slot for the PC Cards cifX PCI, PCIe and Low Profile PCIe</i> , page 33.
	RoHS	Yes
CE Sign	CE Sign	Yes
	Emission	EN 55011:2009 + A1:2010, CISPR 11:2009, Class A (Radio disturbance characteristics - Limits and methods of measurement)
	Immunity	EN 61000-4-2:2009 (Electrostatic discharge test) EN 61000-4-3:2006 + A1:2008 + A2:2010 (Radiated, radio-frequency, electromagnetic field test) EN 61000-4-4:2004 + A1:2010 (Burst Electrical fast transients/burst test) EN 61000-4-5:2006 (Surge test) EN 61000-4-6:2009 (to conducted disturbances, induced by radio- frequency fields) EN 61000-4-8:2010 (power frequency magnetic field test) EN 61000-6-2:2005 + B1:2011 (for industrial environments)
Configuration	Configuration Software Master	SYCON.net

Table 109: Technical Data CIFX 50-2CO\DN

10.1.16 CIFX 50-2DN

CIFX 50-2DN	Parameter	Value
-------------	-----------	-------

CIFX 50-2DN	Parameter	Value
Part	Name	CIFX 50-2DN
	Part No.	1252.510
	Description	PC Card cifX PCI 2 channel DeviceNet Master or Slave
	Function	Communication interface with PCI and 2 x DeviceNet interface
Communication Controller	Type	netX 100 processor
Integrated Memory	RAM	8 MB SDRAM
	FLASH	4 MB serial Flash EPROM
	Size of the Dual-Port Memory	64 KByte
System Interface	Bus Type	PCI, according to [bus spec 1], refer to section <i>Overview</i> , page 114.
	Transmission Rate	33 MHz
	Data Access	DPM or DMA (Direct Memory Access)
	Width for the data access to the Dual-Port Memory (DPM)	32-Bit
DeviceNet Communication	Supported communication standard/ protocol (determined by the loaded firmware)	DeviceNet Master, DeviceNet Slave
DeviceNet Interface	Transmission rate	125 kBit/s, 250 kBit/s, 500 kBit/s
	Interface Type	ISO-11898 according to DeviceNet specification, refer to section <i>DeviceNet Interface</i> , page 108.
	Galvanic Isolation	optically isolated
	Isolation Voltage	1000 VDC (tested for 1 minute)
	Connector	CombiCon male Connector, 5 pin
Display	LED Display	<p>SYS System Status LED</p> <p>MNS 0 Module Network Status 0 (duo LED) for channel X1</p> <p>MNS 1 Module Network Status 1 (duo LED) for channel X2</p> <p>The meaning of the LEDs MNS 0 and MNS 1 depends on the loaded firmware. Refer to chapter <i>LED Descriptions</i>, page 80.</p>
Power supply	Supply Voltage	+3.3 V dc $\pm 5\%$, refer to section <i>Power Supply and Host Interface</i> , page 34.
	Maximum Current at 3.3 V (typically)	700 mA
	Connector	Via PCI Bus
Operation	Rotary Switch Slot Number (Card ID)	To set the Slot Number (Card ID)
Environmental Conditions	Operating temperature range*	-20 °C ... +70 °C
	*Air flow during measurment	0,5m/s
	Storage temperature range	-10 °C ... +70 °C
	Humidity	10 ... 95% relative humidity, no condensation permitted
Device	Dimensions (L x W x H)	120 x 94,5 x 18,5 mm
	Mounting/Installation	PCI slot (3.3 V), refer to section <i>Slot for the PC Cards cifX PCI, PCIe and Low Profile PCIe</i> , page 33.
	RoHS	Yes
CE Sign	CE Sign	Yes
	Emission	EN 55011:2009 + A1:2010, CISPR 11:2009, Class A (Radio disturbance characteristics - Limits and methods of

CIFX 50-2DN	Parameter	Value
		measurement)
	Immunity	EN 61000-4-2:2009 (Electrostatic discharge test) EN 61000-4-3:2006 + A1:2008 + A2:2010 (Radiated, radio-frequency, electromagnetic field test) EN 61000-4-4:2004 + A1:2010 (Burst Electrical fast transients/burst test) EN 61000-4-5:2006 (Surge test) EN 61000-4-6:2009 (to conducted disturbances, induced by radio- frequency fields) EN 61000-4-8:2010 (power frequency magnetic field test) EN 61000-6-2:2005 + B1:2011 (for industrial environments)
Configuration	Configuration Software Master	SYCON.net

Table 110: Technical Data CIFX 50-2DN

10.1.17 CIFX 50-2ASM

CIFX 50-2ASM	Parameter	Value
Part	Name	CIFX 50-2ASM
	Part No.	1252.630
	Description	PC Card cifX PCI 2 channel AS-Interface Master
	Function	Communication interface with PCI and 2 x AS-Interface interface
Communication Controller	Type	netX 100 processor
Integrated Memory	RAM	8 MB SDRAM
	FLASH	4 MB serial Flash EPROM
	Size of the Dual-Port Memory	64 KByte
System Interface	Bus Type	PCI, according to [bus spec 1], refer to section <i>Overview</i> , page 114.
	Transmission Rate	33 MHz
	Data Access	DPM or DMA (Direct Memory Access)
	Width for the data access to the Dual-Port Memory (DPM)	32-Bit
AS-Interface Communication	Supported communication standard/ protocol (determined by the loaded firmware)	AS-Interface Master
AS-Interface Interface	Transmission rate	166,67 kBit/s
	Interface Type	2 *, acc. to IEC 364-4-41, refer to section <i>AS-Interface Interface</i> , page 108.
	Galvanic Isolation	optically isolated
	Isolation Voltage	1000 VDC (tested for 1 minute)
	Connector	CombiCon male Connector, 2 pin
Display	LED Display	SYS System Status LED COM1 LED channel X1 (duo LED) COM2 LED channel X2 (duo LED) Refer to chapter <i>LED Descriptions</i> , page 80.
Power supply	Supply Voltage	+3.3 V dc ±5 %, refer to section <i>Power Supply and Host Interface</i> , page 34.
	Maximum Current at 3.3 V (typically)	700 mA

CIFX 50-2ASM	Parameter	Value
	Connector	Via PCI Bus
Operation	Rotary Switch Slot Number (Card ID)	To set the Slot Number (Card ID)
Environmental Conditions	Operating temperature range*	-20 °C ... +55 °C
	*Air flow during measurement	0,5m/s
	Storage temperature range	-10 °C ... +70 °C
	Humidity	10 ... 95% relative humidity, no condensation permitted
	Environment	For UL compliant usage: The device must be used in a pollution degree 2 environment.
Device	Dimensions (L x W x H)	120 x 94,5 x 18,5 mm
	Mounting/Installation	PCI slot (3.3 V), refer to section <i>Slot for the PC Cards cifX PCI, PCIe and Low Profile PCIe</i> , page 33.
	RoHS	Yes
CE Sign	CE Sign	Yes
	Emission	EN 55011:2009 + A1:2010, CISPR 11:2009, Class A (Radio disturbance characteristics - Limits and methods of measurement)
	Immunity	EN 61000-4-2:2009 (Electrostatic discharge test) EN 61000-4-3:2006 + A1:2008 + A2:2010 (Radiated, radio-frequency, electromagnetic field test) EN 61000-4-4:2004 + A1:2010 (Burst Electrical fast transients/burst test) EN 61000-4-5:2006 (Surge test) EN 61000-4-6:2009 (to conducted disturbances, induced by radio- frequency fields) EN 61000-4-8:2010 (power frequency magnetic field test) EN 61000-6-2:2005 + B1:2011 (for industrial environments)
UL Certification	The device is certified according to UL 508.	UL-File-Nr. E221530
Configuration	Configuration Software	SYCON.net

Table 111: Technical Data CIFX 50-2ASM

10.1.18 CIFX 50E-2ASM

CIFX 50E-2ASM	Parameter	Value
Part	Name	CIFX 50E-2ASM
	Part No.	1253.630
	Description	PC Card cifX PCI Express2 channel AS-Interface Master
	Function	Communication interface with PCI Express and 2 x AS-Interface interface
Communication Controller	Type	netX 500 processor (since hardware revision 04 netX 500; before netX 100)
Integrated Memory	RAM	8 MB SDRAM
	FLASH	4 MB serial Flash EPROM
	Size of the Dual-Port Memory	64 KByte
System Interface	Bus Type	PCI Express, One Lane Port, according to [bus spec 2, Rev. 2.0] and [bus spec 3], refer to section <i>Overview</i> , page 114.
	Transmission Rate	2 GBit/s

CIFX 50E-2ASM	Parameter	Value
	Data Access	DPM or DMA* (Direct Memory Access); *beginning from Hardware Revision 4
	Width for the data access to the Dual-Port Memory (DPM)	32-Bit
AS-Interface Communication	Supported communication standard/ protocol (determined by the loaded firmware)	AS-Interface Master
AS-Interface Interface	Transmission rate	166,67 kBit/s
	Interface Type	2 *, acc. to IEC 364-4-41, refer to section <i>AS-Interface Interface</i> , page 108.
	Galvanic Isolation	optically isolated
	Isolation Voltage	1000 VDC (tested for 1 minute)
	Connector	CombiCon male Connector, 2 pin
Display	LED Display	SYS System Status LED COM1 LED channel X1 (duo LED) COM2 LED channel X2 (duo LED) Refer to ch. <i>LED Descriptions</i> , p. 80.
Power supply	Supply Voltage	+3.3 V dc $\pm 5\%$, refer to section <i>Power Supply and Host Interface</i> , page 34.
	Maximum Current at 3.3 V (typically)	800 mA
	Connector	Via PCI Express Bus
Operation	Rotary Switch Slot Number (Card ID)	To set the Slot Number (Card ID)
Environmental Conditions	Operating temperature range*	0 °C ... +55 °C
	*Air flow during measurement	0,5m/s
	Storage temperature range	0 °C ... +70 °C
	Humidity	10 ... 95% relative humidity, no condensation permitted
	Environment	For UL compliant usage: The device must be used in a pollution degree 2 environment.
Device	Dimensions (L x W x H)	120 x 94,5 x 18,5 mm
	Mounting/Installation	PCI Express x1 slot (3.3 V), refer to section <i>Slot for the PC Cards cifX PCI, PCIe and Low Profile PCIe</i> , page 33.
	RoHS	Yes
CE Sign	CE Sign	Yes
	Emission	EN 55011:2009 + A1:2010, CISPR 11:2009, Class A (Radio disturbance characteristics - Limits and methods of measurement)
	Immunity	EN 61000-4-2:2009 (Electrostatic discharge test) EN 61000-4-3:2006 + A1:2008 + A2:2010 (Radiated, radio-frequency, electromagnetic field test) EN 61000-4-4:2004 + A1:2010 (Burst Electrical fast transients/burst test) EN 61000-4-5:2006 (Surge test) EN 61000-4-6:2009 (to conducted disturbances, induced by radio- frequency fields) EN 61000-4-8:2010 (power frequency magnetic field test) EN 61000-6-2:2005 + B1:2011 (for industrial environments)
UL Certification	The device is certified according to UL 508.	UL-File-Nr. E221530

CIFX 50E-2ASM	Parameter	Value
Configuration	Configuration Software	SYCON.net

Table 112: Technical Data CIFX 50E-2ASM

10.1.19 CIFX 70E-RE, CIFX 70E-RE\MR

CIFX 70E-RE, CIFX 70E-RE\MR	Parameter	Value
Part	Name	CIFX 70E-RE
	Part No.	1.259.100
	Description	PC Card cifX Low Profile PCI Express Real-Time-Ethernet Master or Slave (Low Profile PCIe with RTE), (and variants with additional MRAM ,MR')
	Function	Communication interface with PCI Express and Ethernet interface
Communication Controller	Type	netX 100 processor
Integrated Memory	RAM	8 MB SDRAM
	FLASH	4 MB serial Flash EPROM
	Size of the Dual-Port Memory	64 KByte
	MRAM (only CIFX 70E-RE\MR)	128Kbyte (= 64K Words); Note: Using the cifX Device Driver (from Version 1.1.1.0) access to this memory is possible and it can be used as a remanent memory.
System Interface	Bus Type	PCI Express, One Lane Port, according to [bus spec 2, Rev. 2.0] and [bus spec 3], refer to section <i>Overview</i> , page 114.
	Transmission Rate	2 GBit/s
	Data Access	DPM or DMA (Direct Memory Access)
	Width for the data access to the Dual-Port Memory (DPM)	32-Bit
Ethernet Communication	Supported Real-Time Ethernet communication systems (determined by the loaded firmware)	EtherCAT Master, EtherCAT Slave
		EtherNet/IP Scanner (Master), EtherNet/IP Adapter (Slave),
		Open Modbus/TCP
		POWERLINK Controlled Node/Slave
		PROFINET IO-Controller (Master), PROFINET IO-Device (Slave)
		sercos Master, sercos Slave
	VARAN Client (Slave)	
Ethernet Frame Types	Ethernet II	
Ethernet Interface	Transmission rate	100 MBit/s, 10 MBit/s (depending on loaded firmware)
	Interface Type	100 BASE-TX, 10 BASE-T (depending on loaded firmware), refer to section <i>Ethernet Interface</i> , page 105.
	Galvanic Isolation	isolated
	Isolation Voltage	1000 VDC (tested for 1 minute)
	Half duplex/Full duplex	depending on loaded firmware, supported (at 100 MBit/s)
	Auto-Negotiation	depending on loaded firmware
	Auto-Crossover	depending on loaded firmware
Connector	2* RJ45 Socket	

CIFX 70E-RE, CIFX 70E-RE\MR	Parameter	Value
	Channel 0 and 1	With loaded EtherCAT Master firmware only the RJ45 channel 0 can be used, channel 1 is deactivated. Beginning with the EtherCAT Master firmware version 3 channel 1 can be reactivated if redundancy is activated. For Open Modbus/TCP with V2.3.4.0 and higher both RJ45 channels can be used.
Display	LED Display	<p>SYS System Status LED</p> <p>The meaning of the following LEDs depends on the loaded firmware:</p> <p>COM 0 LED Communication Status 0 (duo LED)</p> <p>COM 1 LED Communication Status 1 (duo LED)</p> <p>LED yellow at RJ45Ch0 and RJ45Ch1, for Ethernet Link status, Ethernet Activity status and additional status</p> <p>LED green</p> <p>Refer to chapter <i>LED Descriptions</i>, page 80.</p>
Power supply	Supply Voltage	+3.3 V dc ±5 %, refer to section <i>Power Supply and Host Interface</i> , page 34.
	Maximum Current at 3.3 V (typically)	800 mA
	Connector	Via PCI Express Bus
Operation	Rotary Switch Slot Number (Card ID)	To set the Slot Number (Card ID)
Environmental Conditions	Operating temperature range*	0 °C ... +65 °C
	*Air flow during measurement	0,5m/s
	Storage temperature range	0 °C ... +70 °C
	Humidity	10 ... 95% relative humidity, no condensation permitted
Device	Dimensions (L x W x H)	119,0 x 69,0 x 18,5 mm
	Mounting/Installation	PCI Express x4 slot (3.3 V), refer to section <i>Slot for the PC Cards cifX PCI, PCIe and Low Profile PCIe</i> , page 33.
	RoHS	Yes
CE Sign	CE Sign	Yes
	Emission	EN 55011:2009 + A1:2010, CISPR 11:2009, Class A (Radio disturbance characteristics - Limits and methods of measurement)
	Immunity	EN 61000-4-2:2009 (Electrostatic discharge test) EN 61000-4-3:2006 + A1:2008 + A2:2010 (Radiated, radio-frequency, electromagnetic field test) EN 61000-4-4:2004 + A1:2010 (Burst Electrical fast transients/burst test) EN 61000-4-5:2006 (Surge test) EN 61000-4-6:2009 (to conducted disturbances, induced by radio- frequency fields) EN 61000-4-8:2010 (power frequency magnetic field test) EN 61000-6-2:2005 + B1:2011 (for industrial environments)
Configuration	Configuration Software Master and Slave	SYCON.net
	Configuration Software Slave	netX Configuration Tool

Table 113: Technical Data CIFX 70E-RE, CIFX 70E-RE\MR

10.1.20 CIFX 100EH-RE\CUBE

CIFX 100EH-RE	Parameter	Value
Part	Name	CIFX 100EH-RE
	Part No.	9016.090
	Description	PC Card cifX PCI Express for Real-Time Ethernet Master or Slave, (low-profile card) exclusively for the installing in KEBA KeControl industry PCs series CP 3XX (Cube).
	Function	Communication interface with PCI Express and Ethernet interface
Communication Controller	Type	netX 100 processor
Integrated Memory	RAM	8 MB SDRAM
	FLASH	4 MB serial Flash EPROM
	Size of the Dual-Port Memory	64 KByte
System Interface	Bus Type	PCI Express, One Lane Port*, (refer to section <i>Overview</i> , page 114 and <i>Pin Assignment for PCI Express Bus CIFX 100EH-RE\CUBE</i> , page 115. *The PC card CIFX 100EH-RE\CUBE can be used for x4 connectors, but not a real x4 connection (mechanical deviation from the standard, it is used only 1 lane).
	Transmission Rate	2 GBit/s
	Data Access	DPM or DMA (Direct Memory Access)
	Width for the data access to the Dual-Port Memory (DPM)	32-Bit
Ethernet Communication	Supported Real-Time Ethernet communication systems (determined by the loaded firmware)	EtherCAT Master, EtherCAT Slave
		EtherNet/IP Scanner (Master), EtherNet/IP Adapter (Slave),
		Open Modbus/TCP
		POWERLINK Controlled Node/Slave
		PROFINET IO-Controller (Master), PROFINET IO-Device (Slave)
		sercos Master, sercos Slave
	VARAN Client (Slave)	
Ethernet Frame Types	Ethernet II	
Ethernet Interface	Transmission rate	100 MBit/s, 10 MBit/s (depending on loaded firmware)
	Interface Type	100 BASE-TX, 10 BASE-T (depending on loaded firmware), refer to section <i>Ethernet Interface</i> , page 105.
	Galvanic Isolation	isolated
	Isolation Voltage	1000 VDC (tested for 1 minute)
	Half duplex/Full duplex	depending on loaded firmware, supported (at 100 MBit/s)
	Auto-Negotiation	depending on loaded firmware
	Auto-Crossover	depending on loaded firmware
	Connector	2* RJ45 Socket
Channel 0 and 1	With loaded EtherCAT Master firmware only the RJ45 channel 0 can be used, channel 1 is deactivated. Beginning with the EtherCAT Master firmware version 3 channel 1 can be reactivated if redundancy is activated. For Open Modbus/TCP with V2.3.4.0 and higher both RJ45 channels can be used.	

CIFX 100EH-RE	Parameter	Value
Display	LED Display	<p>SYS System Status LED</p> <p>The meaning of the following LEDs depends on the loaded firmware:</p> <p>COM 0 LED Communication Status 0 (duo LED)</p> <p>COM 1 LED Communication Status 1 (duo LED)</p> <p>LED yellow at RJ45Ch0 and RJ45Ch1, for Ethernet Link status, Ethernet Activity status and additional status</p> <p>LED green</p> <p>Refer to chapter <i>LED Descriptions</i>, page 80.</p>
Power supply	Supply Voltage	+3.3 V dc \pm 5 %, refer to section <i>Power Supply and Host Interface</i> , page 34.
	Maximum Current at 3.3 V (typically)	800 mA
	Connector	Via PCI Express Bus
Operation	Rotary Switch Slot Number (Card ID)	To set the Slot Number (Card ID)
Environmental Conditions	Operating temperature range*	0 °C ... +65 °C
	*Air flow during measurement	0,5m/s
	Storage temperature range	0 °C ... +70 °C
	Humidity	10 ... 95% relative humidity, no condensation permitted
	Environment	For UL compliant usage: The device must be used in a pollution degree 2 environment.
Device	Dimensions (L x W x H)	110,0 x 69,0 x 18,5 mm
	Mounting/Installation	PCI Express x4 slot (3.3 V), refer to section <i>Slot for the PC Cards cifX PCI, PCIe and Low Profile PCIe</i> , page 33. x4 ⁵ = Four Lane; In the PCI Express x4 slot only lane 0 is used. For further details refer to section <i>Pin Assignment for PCI Express Bus CIFX 100EH-RE\CUBE</i> on page 115.
	Master License	NXLIC Master (Part No 8211.000)
	RoHS	Yes
CE Sign	CE Sign	Yes
	Emission	EN 55011:2009 + A1:2010, CISPR 11:2009, Class A (Radio disturbance characteristics - Limits and methods of measurement)
	Immunity	EN 61000-4-2:2009 (Electrostatic discharge test) EN 61000-4-3:2006 + A1:2008 + A2:2010 (Radiated, radio-frequency, electromagnetic field test) EN 61000-4-4:2004 + A1:2010 (Burst Electrical fast transients/burst test) EN 61000-4-5:2006 (Surge test) EN 61000-4-6:2009 (to conducted disturbances, induced by radio- frequency fields) EN 61000-4-8:2010 (power frequency magnetic field test) EN 61000-6-2:2005 + B1:2011 (for industrial environments)
UL Certification	The device is certified according to UL 508.	UL-File-Nr. E221530
Configuration	Configuration Software	SYCON.net

⁵ The term "x4" refers to the convention of the PCI Express specifications [bus spec 3] to the number of lanes in the slot.

CIFX 100EH-RE	Parameter	Value
	Master and Slave	
	Configuration Software Slave	netX Configuration Tool

Table 114: Technical Data CIFX 100EH-RE\CUBE

10.1.21 CIFX 70E-DP, CIFX 70E-DP\MR

CIFX 70E-DP, CIFX 70E-DP\MR	Parameter	Value
Part	Name	CIFX 70E-DP CIFX 70E-DP\MR
	Part No.	1259.410 1259.413
	Description	PC Card cifX Low Profile PCI Express PROFIBUS DP Master or Slave and PROFIBUS MPI Device (Low Profile PCIe with PROFIBUS), (and variants with additional MRAM ,MR')
	Function	Communication interface with PCI Express and PROFIBUS interface
Communication Controller	Type	netX 100 processor
Integrated Memory	RAM	8 MB SDRAM
	FLASH	4 MB serial Flash EPROM
	Size of the Dual-Port Memory	64 KByte
	MRAM (only CIFX 70E-DP\MR)	128Kbyte (= 64K Words); Note: Using the cifX Device Driver (from Version 1.1.1.0) access to this memory is possible and it can be used as a remanent memory.
System Interface	Bus Type	PCI Express, One Lane Port, according to [bus spec 2, Rev. 2.0] and [bus spec 3], refer to section <i>Overview</i> , page 114.
	Transmission Rate	2 GBit/s
	Data Access	DPM or DMA (Direct Memory Access)
	Width for the data access to the Dual-Port Memory (DPM)	32-Bit
PROFIBUS Communication	Supported communication standard/ protocol (determined by the loaded firmware)	PROFIBUS DP Master, PROFIBUS DP Slave, PROFIBUS MPI Device
PROFIBUS Interface	Transmission rate	9,6 kBit/s, 19,2 kBit/s, 31,25 kBit/s, 45,45 kBit/s, 93,75 kBit/s, 187,5 kBit/s, 500 kBit/s, 1,5 MBit/s, 3 MBit/s, 6 MBit/s, 12 MBit/s
	Interface Type	RS 485, refer to section <i>PROFIBUS Interface</i> , page 107.
	Galvanic Isolation	isolated
	Isolation Voltage	1000 VDC (tested for 1 minute)
	Connector	DSub female Connector, 9 pin
Display	LED Display	SYS System Status LED COM LED Communication Status (duo LED) The meaning of the COM LED depends on the loaded firmware. Refer to chapter <i>LED Descriptions</i> , page 80.
Power supply	Supply Voltage	+3.3 V dc \pm 5 %, refer to section <i>Power Supply and Host Interface</i> , page 34.
	Maximum Current at 3.3 V (typically)	800 mA
	Connector	Via PCI Express Bus
Operation	Rotary Switch Slot Number	To set the Slot Number (Card ID)

CIFX 70E-DP, CIFX 70E-DP\MR	Parameter	Value
	(Card ID)	
Environmental Conditions	Operating temperature range*	0 °C ... +65 °C
	*Air flow during measurement	0,5m/s
	Storage temperature range	0 °C ... +70 °C
	Humidity	10 ... 95% relative humidity, no condensation permitted
Device	Dimensions (L x W x H)	119,0 x 69,0 x 18,5 mm
	Mounting/Installation	PCI Express x1 slot (3.3 V), refer to section <i>Slot for the PC Cards cifX PCI, PCIe and Low Profile PCIe</i> , page 33.
	RoHS	Yes
CE Sign	CE Sign	Yes
	Emission	EN 55011:2009 + A1:2010, CISPR 11:2009, Class A (Radio disturbance characteristics - Limits and methods of measurement)
	Immunity	EN 61000-4-2:2009 (Electrostatic discharge test) EN 61000-4-3:2006 + A1:2008 + A2:2010 (Radiated, radio-frequency, electromagnetic field test) EN 61000-4-4:2004 + A1:2010 (Burst Electrical fast transients/burst test) EN 61000-4-5:2006 (Surge test) EN 61000-4-6:2009 (to conducted disturbances, induced by radio- frequency fields) EN 61000-4-8:2010 (power frequency magnetic field test) EN 61000-6-2:2005 + B1:2011 (for industrial environments)
Configuration	Configuration Software Master and Slave	SYCON.net
	Configuration Software Slave	netX Configuration Tool

Table 115: Technical Data CIFX 70E-DP, CIFX 70E-DP\MR

10.1.22 CIFX 70E-CO, CIFX 70E-CO\MR

CIFX 70E-CO, CIFX 70E-CO\MR	Parameter	Value
Part	Name	CIFX 70E-CO CIFX 70E-CO\MR
	Part No.	1259.500 1259.503
	Description	PC-Karte cifX Low Profile PCI Express CANopen Master or Slave (Low Profile PCIe mit CANopen), (and variants with additional MRAM ,MR')
	Function	Communication interface with PCI Express and CANopen interface
Communication Controller	Type	netX 100 processor
Integrated Memory	RAM	8 MB SDRAM
	FLASH	4 MB serial Flash EPROM
	Size of the Dual-Port Memory	64 KByte
	MRAM (only CIFX 70E-CO\MR)	128Kbyte (= 64K Words); Note: Using the cifX Device Driver (from Version 1.1.1.0) access to this memory is possible and it can be used as a remanent memory.
System Interface	Bus Type	PCI Express, One Lane Port, according to [bus spec 2, Rev. 2.0] and [bus spec 3], refer to section <i>Overview</i> , page 114.

CIFX 70E-CO, CIFX 70E-CO\MR	Parameter	Value
	Transmission Rate	2 GBit/s
	Data Access	DPM or DMA (Direct Memory Access)
	Width for the data access to the Dual-Port Memory (DPM)	32-Bit
CANopen Communication	Supported communication standard/ protocol (determined by the loaded firmware)	CANopen Master, CANopen Slave
CANopen Interface	Transmission rate	10 kBit/s, 20 kBit/s, 50 kBit/s, 100 kBit/s, 125 kBit/s, 250 kBit/s, 500 kBit/s, 800 kBit/s, 1 MBit/s
	Interface Type	ISO-11898, refer to section <i>CANopen Interface</i> , page 107.
	Galvanic Isolation	optically isolated
	Isolation Voltage	1000 VDC (tested for 1 minute)
	Connector	DSub male Connector, 9 pin
Display	LED Display	SYS System Status LED CAN CANopen Status (duo LED)
		The meaning of the CAN LED depends on the loaded firmware. Refer to chapter <i>LED Descriptions</i> , page 80.
Power supply	Supply Voltage	+3.3 V dc $\pm 5\%$, refer to section <i>Power Supply and Host Interface</i> , page 34.
	Maximum Current at 3.3 V (typically)	800 mA
	Connector	Via PCI Express Bus
Operation	Rotary Switch Slot Number (Card ID)	To set the Slot Number (Card ID)
Environmental Conditions	Operating temperature range*	0 °C ... +65 °C
	*Air flow during measurement	0,5m/s
	Storage temperature range	0 °C ... +70 °C
	Humidity	10 ... 95% relative humidity, no condensation permitted
Device	Dimensions (L x W x H)	119,0 x 69,0 x 18,5 mm
	Mounting/Installation	PCI Express x1 slot (3.3 V), refer to section <i>Slot for the PC Cards cifX PCI, PCIe and Low Profile PCIe</i> , page 33.
	RoHS	Yes
CE Sign	CE Sign	Yes
	Emission	EN 55011:2009 + A1:2010, CISPR 11:2009, Class A (Radio disturbance characteristics - Limits and methods of measurement)
	Immunity	EN 61000-4-2:2009 (Electrostatic discharge test) EN 61000-4-3:2006 + A1:2008 + A2:2010 (Radiated, radio-frequency, electromagnetic field test) EN 61000-4-4:2004 + A1:2010 (Burst Electrical fast transients/burst test) EN 61000-4-5:2006 (Surge test) EN 61000-4-6:2009 (to conducted disturbances, induced by radio- frequency fields) EN 61000-4-8:2010 (power frequency magnetic field test) EN 61000-6-2:2005 + B1:2011 (for industrial environments)
Configuration	Configuration Software Master and Slave	SYCON.net
	Configuration Software Slave	netX Configuration Tool

Table 116: Technical Data CIFX 70E-CO, CIFX 70E-CO\MR

10.1.23 CIFX 70E-DN, CIFX 70E-DN\MR

CIFX 70E-DN, CIFX 70E-DN\MR	Parameter	Value	
Part	Name	CIFX 70E-DN	CIFX 70E-DN\MR
	Part No.	1259.510	1259.513
	Description	PC Card cifX Low Profile PCI Express DeviceNet Master or Slave (Low Profile PCIe with DeviceNet), (and variants with additional MRAM ,MR')	
	Function	Communication interface with PCI Express and DeviceNet interface	
Communication Controller	Type	netX 100 processor	
Integrated Memory	RAM	8 MB SDRAM	
	FLASH	4 MB serial Flash EPROM	
	Size of the Dual-Port Memory	64 KByte	
	MRAM (only CIFX 70E-DN\MR)	128Kbyte (= 64K Words); Note: Using the cifX Device Driver (from Version 1.1.1.0) access to this memory is possible and it can be used as a remanent memory.	
System Interface	Bus Type	PCI Express, One Lane Port, according to [bus spec 2, Rev. 2.0] and [bus spec 3], refer to section <i>Overview</i> , page 114.	
	Transmission Rate	2 GBit/s	
	Data Access	DPM or DMA (Direct Memory Access)	
	Width for the data access to the Dual-Port Memory (DPM)	32-Bit	
DeviceNet Communication	Supported communication standard/ protocol (determined by the loaded firmware)	DeviceNet Master, DeviceNet Slave	
DeviceNet Interface	Transmission rate	125 kBit/s, 250 kBit/s, 500 kBit/s	
	Interface Type	ISO-11898 according to DeviceNet specification, refer to section <i>DeviceNet Interface</i> , page 108.	
	Galvanic Isolation	optically isolated	
	Isolation Voltage	1000 VDC (tested for 1 minute)	
	Connector	CombiCon male Connector, 5 pin	
Display	LED Display	SYS System Status LED MNS Module Network Status (duo LED) The meaning of the MNS LED depends on the loaded firmware. Refer to chapter <i>LED Descriptions</i> , page 80.	
Power supply	Supply Voltage	+3.3 V dc $\pm 5\%$, refer to section <i>Power Supply and Host Interface</i> , page 34.	
	Maximum Current at 3.3 V (typically)	800 mA	
	Connector	Via PCI Express Bus	
Operation	Rotary Switch Slot Number (Card ID)	To set the Slot Number (Card ID)	
Environmental Conditions	Operating temperature range*	0 °C ... +65 °C	
	*Air flow during measurment	0,5m/s	
	Storage temperature range	0 °C ... +70 °C	
	Humidity	10 ... 95% relative humidity, no condensation permitted	
Device	Dimensions (L x W x H)	119,0 x 69,0 x 18,5 mm	
	Mounting/Installation	PCI Express x1 slot (3.3 V), refer to section <i>Slot for the PC</i>	

CIFX 70E-DN, CIFX 70E-DN\MR	Parameter	Value
		<i>Cards cifX PCI, PCIe and Low Profile PCIe</i> , page 33.
	RoHS	Yes
CE Sign	CE Sign	Yes
	Emission	EN 55011:2009 + A1:2010, CISPR 11:2009, Class A (Radio disturbance characteristics - Limits and methods of measurement)
	Immunity	EN 61000-4-2:2009 (Electrostatic discharge test) EN 61000-4-3:2006 + A1:2008 + A2:2010 (Radiated, radio-frequency, electromagnetic field test) EN 61000-4-4:2004 + A1:2010 (Burst Electrical fast transients/burst test) EN 61000-4-5:2006 (Surge test) EN 61000-4-6:2009 (to conducted disturbances, induced by radio- frequency fields) EN 61000-4-8:2010 (power frequency magnetic field test) EN 61000-6-2:2005 + B1:2011 (for industrial environments)
Configuration	Configuration Software Master and Slave	SYCON.net
	Configuration Software Slave	netX Configuration Tool

Table 117: Technical Data CIFX 70E-DN, CIFX 70E-DN\MR

10.2 PCI IDs PC Cards cifX on the PCI Bus

On the PCI bus the PC Cards cifX have the following PCI IDs:

PCI IDs	Value
VendorID	0x15CF
DeviceID	0x0000
Subsystem Vendor ID	0x0000
Subsystem Device ID	0x0000

Table 118: PCI IDs PC Cards cifX on the PCI Bus

10.3 Supported PCI-Bus Commands

From the following table you can see which PCI bus commands are supported by the Hilscher PC Cards cifX *PCI*, *PCI Express* and *Low Profile PCI Express*.

C/BE3#	C/BE2#	C/BE1#	C/BE0#	Command Type	supported
0	0	0	0	Interrupt Acknowledge	no
0	0	0	1	Special Cycle	no
0	0	1	0	I/O Read	✓
0	0	1	1	I/O Write	✓
0	1	0	0	Reserved	no
0	1	0	1	Reserved	no
0	1	1	0	Memory Read	✓
0	1	1	1	Memory Write	✓
1	0	0	0	Reserved	no
1	0	0	1	Reserved	no
1	0	1	0	Configuration Read	✓
1	0	1	1	Configuration Write	✓
1	1	0	0	Memory Read Multiple	no
1	1	0	1	Dual Address Cycle	no
1	1	1	0	Memory Read Line	no
1	1	1	1	Memory Write and Invalidate	no

Table 119: Supported / not supported PCI Bus Commands

C/BE = Bus Command and Byte Enable Signal of PCI

10.4 Technical Data of the Communication Protocols

10.4.1 EtherCAT Master

Parameter	Description
Maximum number of EtherCAT slaves	Maximum 200 Slaves. The number of usable slaves depends on the available memory for the configuration file. See 'configuration file' below.
Maximum number of cyclic input data	5760 bytes
Maximum number of cyclic output data	5760 bytes
Minimum bus cycle time	205 μ s, depending on the used number of slaves and the used number of cyclic input data and output data. Recommended is a cycle time of 1 ms and higher.
Acyclic communication	CoE (CANopen over EtherCAT) CoE-Upload, CoE-Download Maximum 1500 bytes
Functions	Get OD List Get object description Get entry description Emergency Slave diagnostics
Bus Scan	Supported
Redundancy	Supported, but not at the same time with Distributed Clocks
Distributed Clocks	Supported, but not at the same time with Redundancy
Topology	Line or ring
Baud rate	100 MBit/s
Data transport layer	Ethernet II, IEEE 802.3
Configuration File (ethercat.xml or config.nxd)	PC cards PCI, PCI Express, PCI Express Low Profile, Mini PCI, Compact PCI, Mini PCI Express, PCI-104 Real-Time Ethernet: Maximum 1 MByte PC cards PC/104 Real-Time Ethernet: Maximum 2 MByte
Limitations	The size of the bus configuration file is limited by the size of the RAM Disk (1 Mbyte) or FLASH disk (2 Mbyte). All CoE Uploads, Downloads and information services must fit in one TLR-Packet. Fragmentation is not supported Distubuted Clock and Redundancy can not be used at the same time.
Reference to firmware/stack version	V3.0.x.x

Table 120: Technical Data EtherCAT Master Protocol

10.4.2 EtherCAT Slave

Parameter	Description
Maximum number of cyclic input data	256* bytes
Maximum number of cyclic output data	256* bytes
Acyclic communication	SDO SDO Master-Slave SDO Slave-Slave (depending on Master capability)
Type	Complex Slave
Functions	Emergency
FMMUs	3
SYNC Manager	4
Distributed Clocks (DC)	Supported, 32 Bit
Baud rate	100 MBit/s
Data transport layer	Ethernet II, IEEE 802.3
Limitation	LRW is not supported
Reference to firmware/stack version	V2.5.x.x and V4.2.x.x

Table 121: Technical Data EtherCAT Slave Protocol



Note: * The loadable firmware supports for the number of cyclic input data and for cyclic output data in total up to 512 bytes. If more than 256 bytes for input data or for output data shall be exchanged via EtherCAT, then a customer specific XML file is necessary. Additionally the following formula applies: The sum of the input data length and the output data length may not exceed 512 bytes, where each length has to be rounded up to the next multiple of 4 for this calculation.

10.4.3 EtherNet/IP Scanner (Master)

Parameter	Description
Maximum number of EtherNet/IP connections	64 connections for implicit and explicit
Maximum number of total cyclic input data	5712 bytes
Maximum number of total cyclic output data	5760 bytes
Maximum number of cyclic input data	504 bytes per slave per telegram
Maximum number of cyclic output data	504 bytes per slave per telegram
IO Connection type	Cyclic, minimum 1 ms (depending on used number of connections and used number of input and output data)
Maximum number of unscheduled data	1400 bytes per telegram
UCMM, Class 3	Supported
Explicit Messages, Client and Server Services	Get_Attribute_Single/All Set_Attribute_Single/All
Quick connect	Supported
Predefined standard objects	Identity Object Message Route Object Assembly Object Connection Manager Ethernet Link Object TCP/IP Object DLR Object QoS Object
Maximal number of user specific objects	20
Topology	Tree, Line, Ring
DLR (Device Level Ring)	Beacon based 'Ring Node'
ACD (Address Conflict Detection)	Supported
DHCP	Supported
BOOTP	Supported
Baud rates	10 and 100 MBit/s
Data transport layer	Ethernet II, IEEE 802.3
Switch function	Integrated
Limitations	CIP Sync Services are not implemented TAGs are not supported
Reference to firmware/stack version	V2.6.x.x

Table 122: Technical Data EtherNet/IP Scanner (Master) Protocol

10.4.4 EtherNet/IP Adapter (Slave)

Parameter	Description
Maximum number of input data	504 bytes
Maximum number of output data	504 bytes
IO connection types (implicit)	1 exclusive owner, 1 listen only, 1 input only
IO Connection trigger types	Cyclic, minimum 1 ms* Application Triggered, minimum 1 ms* Change Of State, minimum 1 ms* * depending on number of connections and number of input and output data
Explicit Messages	Connected and unconnected
Maximum number of connections	8, explicit and implicit connections
Unconnected Message Manager (UCMM)	Supported
Quick connect	Supported
Predefined standard objects	Identity Object Message Route Object Assembly Object Connection Manager DLR Object QoS Object TCP/IP Object Ethernet Link Object
Reset services	Identity Object Reset Service of Type 0 and 1
Maximum number of user specific objects	20
DLR V2 (ring topology)	Supported
ACD (Address Conflict Detection)	Supported
DHCP	Supported
BOOTP	Supported
Baud rates	10 and 100 MBit/s
Duplex modes	Half duplex, Full duplex, Auto negotiation
MDI modes	MDI, MDI-X, Auto-MDIX
Data transport layer	Ethernet II, IEEE 802.3
Switch function	Integrated
Limitations	CIP Sync Services are not implemented TAGs are not supported
Reference to firmware/stack version	V2.7.x.x

Table 123: Technical Data EtherNet/IP Adapter (Slave) Protocol

10.4.5 Open Modbus/TCP

Parameter	Description
Maximum number of input data	2880 Registers
Maximum number of output data	2880 Registers
Acyclic communication	Read/Write Register: - Maximum 125 Registers per Read Telegram (FC 3, 4, 23), - Maximum 121 Registers per Write Telegram (FC 23), - Maximum 123 Registers per Write Telegram (FC 16) Read/Write Coil: - Maximum 2000 Coils per Read Telegram (FC 1, 2), - Maximum 1968 Coils per Write Telegram (FC 15)
Modbus Function Codes	1, 2, 3, 4, 5, 6, 7, 15, 16, 23* * Function Code 23 can be used via the packet API, but not with the Command Table.
Protocol Mode	Message Mode (Client Mode): - Client (using the Command Table: The data is stored in the I/O process data image) - Client (using the packet API: The I/O process data image is not used) - Server (using the packet API: The I/O process data image is not used) I/O Mode (Server Mode): - Server (only) (The data is stored in the I/O process data image)
Baud rates	10 and 100 MBit/s
Data transport layer	Ethernet II, IEEE 802.3
Reference to firmware/stack version	V2.5.x.x

Table 124: Technical Data Open Modbus/TCP Protocol

10.4.6 POWERLINK Controlled Node/Slave

Parameter	Description
Maximum number of cyclic input data	1490 bytes
Maximum number of cyclic output data	1490 bytes
Acyclic data transfer	SDO Upload/Download
Functions	SDO over ASND and UDP
Baud rate	100 MBit/s, half-duplex
Data transport layer	Ethernet II, IEEE 802.3
Ethernet POWERLINK version	V 2
Limitation	No slave to slave communication
Reference to firmware/stack version	V2.1.x.x

Table 125: Technical Data POWERLINK Controlled Node (Slave) Protocol

10.4.7 PROFINET IO-Controller

Parameter	Description
Maximum number of PROFINET IO Devices	128
Maximum number of total cyclic input data	5712 bytes (including IOxS status bytes)
Maximum number of total cyclic output data	5760 bytes (including IOxS status bytes)
Maximum number of cyclic input data	1440 bytes per device (= IOCR data length including IOxS status bytes)
Maximum number of cyclic output data	1440 bytes per device (= IOCR data length including IOxS status bytes)
Acyclic communication	Read/Write Record Limited to 1392 bytes per telegram Limited to 4096 bytes per request
Alarm processing	yes, but requires handling in host application program
Diagnostic data	One 200 byte buffer per IO device
DCP functions via API	Name Assignment IO-Devices (DCP SET NameOfStation) Set IO-Devices IP (DCP SET IP) Signal IO-Device (DCP SET SIGNAL) Reset IO-Device to factory settings (DCP Reset FactorySettings) Bus scan (DCP IDENTIFY ALL)
Supported Protocols	RTC – Real Time Cyclic Protocol, Class 1 RTA – Real Time Acyclic Protocol DCP – Discovery and configuration Protocol CL-RPC – Connectionless Remote Procedure Call
Context management by CL-RPC	Supported
Minimum cycle time	1 ms Different IO-Devices can be configured with different cycle times
Functions	Fast Startup of PROFINET IO Devices supported
Baud rate	100 MBit/s Full-Duplex mode
Data transport layer	Ethernet II, IEEE 802.3
Configuration file	Maximum 1 MByte
Limitations	RT over UDP not supported Multicast communication not supported DHCP is not supported (neither for PROFINET IO-Controller nor for the IO-Devices) Only one IOCR per IO Device NameOfStation of IO Controller CANNOT be set using the DCP SET NameOfStation service but only at start-up while configuring the IO Controller The buffer for IO-Device diagnosis data will be overwritten in case of multiple diagnostic events. Only one (the last) event is stored at the same time. If a single event produces more than 200 bytes of diagnosis data, only the first 200 bytes will be taken care of. The usable (minimum) cycle time depends on the number of used IO Devices, the number of used input and output data. The cycle-time, the number of configured IO Devices and the amount of IO data depend on each other. For example it is not possible due to performance reasons to have 128 IO Devices communication with cycle-time 1ms. The size of the bus configuration file is limited by the size of the RAM Disk (1 MByte) WriteMultiple-Record service is not supported

Parameter	Description
Reference to firmware/stack version	V2.6.x.x

Table 126: Technical Data PROFINET IO RT Controller

10.4.8 PROFINET IO-Device (V3.4)

Parameter	Description
Maximum number of cyclic input data	1024 bytes
Maximum number of cyclic output data	1024 bytes
Acyclic communication	Read/Write Record, max. 1024 bytes per telegram
Alarm Types	Process Alarm, Diagnostic Alarm, Return of SubModule Alarm Plug Alarm (implicit), Pull Alarm (implicit)
Supported protocols	RTC – Real Time Cyclic Protocol, Class 1 and 2 (unsynchronized), Class 3 (synchronized) RTA – Real Time Acyclic Protocol DCP – Discovery and configuration Protocol CL-RPC – Connectionless Remote Procedure Call LLDP – Link Layer Discovery Protocol SNMP – Simple Network Management Protocol MRP – MRP Client
Used Protocols (subset)	UDP, IP, ARP, ICMP (Ping)
Topology recognition	LLDP, SNMP V1, MIB2, physical device
VLAN- and priority tagging	yes
Context Management by CL-RPC	Supported
Identification & Maintenance	Read and write of I&M1-4
Minimum cycle time	1 ms for RTC1 and RTC2 250 µs for RTC3
Baud rate	100 MBit/s
Data transport layer	Ethernet II, IEEE 802.3
Limitations	RT over UDP not supported Multicast communication not supported Only one device instance is supported DHCP is not supported IRT “flex” (synchronized RT Class 2) is not supported FastStartUp is not supported. Media Redundancy (except MRP client) is not supported Access to the submodule granular status bytes (IOCS) is not supported. The amount of configured IO-data influences the minimum cycle time that can be reached. Supervisor-AR is not supported, Supervisor-DA-AR is supported Only 1 Input-CR and 1 Output-CR are supported Multiple WriteRequests are not supported Using little endian (LSB-MSB) byte order for cyclic process data instead of default big endian (MSB-LSB) byte order may have an negative impact on minimum reachable cycle time
Reference to firmware/stack version	V3.4.x.x

Table 127: Technical Data PROFINET IO RT IRT Device Protocol

10.4.9 PROFINET IO Device (V3.5)

Parameter	Description
Maximum number of cyclic input data	1440 bytes
Maximum number of cyclic output data	1440 bytes
Maximum number of submodules	255 submodules per Application Relation at the same time, 1000 submodules can be configured
Multiple Application Relations (AR)	The Stack can handle up to 2 IO-ARs, one Supervisor AR and one Supervisor-DA AR at the same time
Acyclic communication	Read/Write Record, max. 1024 bytes per telegram
Alarm Types	Process Alarm, Diagnostic Alarm, Return of SubModule Alarm, Plug Alarm (implicit), Pull Alarm (implicit)
Supported protocols	RTC – Real Time Cyclic Protocol, class 1 (unsynchronized), class 3 (synchronized) RTA – Real Time Acyclic Protocol DCP – Discovery and configuration Protocol CL-RPC – Connectionless Remote Procedure Call LLDP – Link Layer Discovery Protocol SNMP – Simple Network Management Protocol MRP – MRP Client
Topology recognition	LLDP, SNMP V1, MIB2, physical device
Identification & Maintenance	Read and write of I&M1-4
Minimum cycle time	1 ms for RT_CLASS_1 250 µs for RT_CLASS_3
IRT Support	RT_CLASS_3
Media Redundancy	MRP client is supported
Additional features	DCP, VLAN- and priority tagging, Shared Device
Baud rate	100 MBit/s
Data transport layer	Ethernet II, IEEE 802.3
PROFINET IO specification	V2.2 (legacy startup) and V2.3 (but advanced startup only for RT) are supported
Limitations	RT over UDP not supported Multicast communication not supported Only one device instance is supported DHCP is not supported FastStartUp is not supported The amount of configured IO-data influences the minimum cycle time that can be reached. Only 1 Input-CR and 1 Output-CR are supported Using little endian (LSB-MSB) byte order for cyclic process data instead of default big endian (MSB-LSB) byte order may have a negative impact on minimum reachable cycle time System Redundancy (SR-AR) and Configuration-in-Run (CiR) are not supported Max. 255 submodules can be used simultaneously within one specific Application Relation Advanced Startup according Profinet specification V2.3 is NOT yet supported for IRT As there is no official certification available for Profinet IO specification V2.3 at the time of release of the stack there is no guarantee that this implementation will pass such a certification once it is available
Reference to firmware/stack version	V3.5.26.x

Table 128: Technical Data PROFINET IO RT IRT Device Protocol

10.4.10 sercos Master

Parameter	Description
Maximum number of cyclic input data	5760 bytes (including Connection Control per Connection)
Maximum number of cyclic output data	5760 bytes (including Connection Control per Connection)
Maximum number of configured slave devices	511
Minimum cycle time	250 µs
Acyclic communication	Service channel: Read/Write/Commands
Functions	Bus Scan
Communication phases	NRT, CP0, CP1, CP2, CP3, CP4
Topology	Line and double ring
Redundancy	supported
NRT channel	supported
Hot-Plug	supported
Cross Communication	supported, but only if the master is configured by the host application program by packets.
Baud rate	100 MBit/s, full duplex
Data transport layer	Ethernet II, IEEE 802.3
Auto crossover	supported
Supported sercos version	Communication Specification Version 1.3
TCP/IP stack	integrated
Reference to firmware/stack version	V2.1.x.x

Table 129: Technical Data sercos Master Protocol

10.4.11 sercos Slave

Parameter	Description
Maximum number of cyclic input data (Tx) of all slaves	128 bytes (including Connection Control and IO Status)
Maximum number of cyclic output data (Rx) of all slaves	128 bytes (including Connection Control and IO Status)
Maximum number of slave devices	8
Maximum number of applicable sercos addresses	1 ... 511
Minimum cycle time	250 µs
Topology	Line and ring
Communication phases	NRT, CP0, CP1, CP2, CP3, CP4
Acyclic Communication (Service Channel)	Read/Write/Standard Commands
Baud rate	100 MBit/s
Data transport layer	Ethernet II, IEEE 802.3
Supported sercos version	sercos in the third generation Communication Specification Version 1.1.2
Supported sercos Communication Profiles	SCP_FixCFG Version 1.1.1 SCP_VarCFG Version 1.1.1 SCP_VarCFG Version 1.1.3
Supported User SCP Profiles	SCP_WD Version 1.1.1 SCP_Diag Version 1.1.1 SCP_RTb Version 1.1.1 SCP_Mux Version 1.1.1 SCP_Sig Version 1.1.1 SCP_ExtMuX Version 1.1.2 SCP_RTbListProd Version 1.3 SCP_RTbListCons Version 1.3 SCP_RTbWordProd Version 1.3 SCP_RTbWordCons Version 1.3 SCP_OvSBasic Version 1.3 SCP_WDCon Version 1.3
Supported FSP profiles	FSP_IO FSP_Drive
SCP Sync	Supported
SCP_NRT	Supported
S/IP	Supported
Identification LED	Supported
Storage location of object dictionary	Mixed mode
Limitations	Max. 2 connections: 1 for consumer and 1 for producer Modifications of the Service-Channel Object Dictionary will be volatile after reset (if it resides on device) Hot plug is not supported yet Cross communication not supported yet
Reference to firmware/stack version	V3.1.x.x

Table 130: Technical Data sercos Slave Protocol

10.4.12 VARAN Client (Slave)

Parameter	Description
Maximum number of cyclic input data	128 bytes
Maximum number of cyclic output data	128 bytes
Memory Area	Read Memory Area 1, Write Memory Area 1
Functions	Memory Read Memory Write
Integrated 2 port splitter for daisy chain topology	Supported
Baud rate	100 MBit/s
Data transport layer	Ethernet II, IEEE 802.3
VARAN protocol version	1.1.1.0
Limitations	Integrated EMAC for IP data exchange with client application not supported SPI single commands (optional feature) not supported Memory area 2 is not supported.
Reference to firmware/stack version	V1.0.x.x

Table 131: Technical Data VARAN Client Protocol

10.4.13 PROFIBUS DP Master

Parameter	Description
Maximum number of PROFIBUS DP slaves	125 (DPV0/DPV1)
Maximum number of total cyclic input data	5712 bytes
Maximum number of total cyclic output data	5760 bytes
Maximum number of cyclic input data	244 bytes per slave
Maximum number of cyclic output data	244 bytes per slave
Configuration data	Max. 244 bytes per slave
Parameterization data per slave	7 bytes standard parameter per slave Max. 237 bytes application specific parameters per slave
Acyclic communication	DPV1 class 1 read, write DPV1 class 1 alarm DPV1 class 2 initiate, read, write, data transport, abort
Maximum number of acyclic read/write	240 bytes per slave and telegram
Functions	Configuration in Run (CiR), requires host application program support Timestamp (Master functionality)
Redundancy	Supported, requires host application program support
Baud rate	9,6 kBits/s, 19,2 kBits/s, 31,25 kBits/s, 45,45 kBits/s 93,75 kBits/s, 187,5 kBits/s, 500 kBits/s, 1, 5 MBits/s, 3 MBits/s, 6 MBits/s, 12 MBit/s Auto baud rate detection is not supported
Data transport layer	PROFIBUS FDL
Limitations	DPV2 isochronous mode and slave slave communication are not supported. The redundancy function can not be used, if the master is configured by the host application program by packets.
Reference to firmware/stack version	V2.6.x.x

Table 132: Technical Data PROFIBUS DP Master Protocol

10.4.14 PROFIBUS DP Slave

Parameter	Description
Maximum number of cyclic input data	244 bytes
Maximum number of cyclic output data	244 bytes
Maximum number of acyclic data (read/write)	240 bytes/telegram
Maximum number of modules	24
Configuration data	Max. 244 bytes
Parameter data	237 bytes application specific parameters
Acyclic communication	DP V1 Class 1 Read/Write DP V1 Class 1 Alarm DP V1 Class 2 Read/Write/Data Transport
Baud rate	9,6 kBits/s, 19,2 kBits/s, 31,25 kBits/s, 45,45 kBits/s, 93,75 kBits/s, 187,5 kBits/s, 500 kBits/s, 1, 5 MBits/s, 3 MBits/s, 6 MBits/s, 12 MBit/s Auto baudrate detection is supported
Data transport layer	PROFIBUS FDL
Limitations	SSCY1S – Slave to slave communication state machine not implemented Data exchange broadcast not implemented I&M LR services other than Call-REQ/RES are not supported yet
Reference to firmware/stack version	V2.7.x.x

Table 133: Technical Data PROFIBUS DP Slave Protocol

10.4.15 PROFIBUS MPI

Parameter	Description
Maximum number of MPI connections	126
Maximum number of write data	216 bytes
Maximum number of read data	222 bytes
Functions	MPI Read/Write DB (data block), M (marker), Q (output), C (Counter), T (Timer) MPI Read I (Input) Data type bit to access to DB (data block), M (marker), Q (output) and I (Input, read only) MPI Connect (automatically when first read/write function is used) MPI Disconnect, MPI Disconnect All MPI Get OP Status MPI transparent (expert use only)
Baud rate	Fixed values ranging from 9,6 kBits/s to 12 MBit/s Auto-detection mode is supported
Data transport layer	PROFIBUS FDL
Reference to firmware/stack version	2.4.x.x

Table 134: Technical Data PROFIBUS-MPI Protocol

10.4.16 CANopen Master

Parameter	Description
Maximum number of CANopen nodes	126
Maximum number of cyclic input data	3584 bytes
Maximum number of cyclic output data	3584 bytes
Maximum number of receive PDOs	512
Maximum number of transmit PDOs	512
Exchange of process data	Via PDO transfer: - synchronized, - remotely requested and - event driven (change of date)
Acyclic communication	SDO Upload/Download, max. 512 bytes per request
Functions	Emergency message (consumer and producer) Node guarding / life guarding, heartbeat PDO mapping NMT Master SYNC protocol (producer) Simple boot-up process, reading object 1000H for identification
Baud rates	10 kBits/s, 20 kBits/s, 50 kBits/s, 100 kBits/s, 125 kBits/s, 250 kBits/s, 500 kBits/s, 800 kBits/s, 1 MBits/s
CAN layer 2 access	Send/receive via API supported (11 bit/29 bit)
Data transport layer	CAN Frames
CAN Frame type for CANopen	11 Bit
Reference to version	V2.11.x.x

Table 135: Technical Data CANopen Master Protocol

10.4.17 CANopen Slave

Parameter	Description
Maximum number of cyclic input data	512 bytes
Maximum number of cyclic output data	512 bytes
Maximum number of receive PDOs	64
Maximum number of transmit PDOs	64
Exchange of process data	Via PDO transfer - synchronized, - remotely requested and - event driven (change of date, event timer) On request of the host application program by packet
Acyclic communication	SDO upload/download (server only) Emergency message (producer) Timestamp (producer/consumer)
Functions	Node guarding / life guarding Heartbeat: 1 producer, max. 64 consumer PDO mapping NMT Slave SYNC protocol (consumer) Error behaviour (configurable): - in state operational: change to state pre-operational - in any state: no state change - in state operational or pre-operational: change to state stopped
Baud rates	10 kBits/s, 20 kBits/s, 50 kBits/s, 100 kBits/s, 125 kBits/s, 250 kBits/s, 500 kBits/s, 800 kBits/s, 1 MBits/s Auto baudrate detection is supported
CAN layer 2 access	Send/receive via API supported (11 bit/29 bit)
Data transport layer	CAN Frames
CAN Frame type for CANopen	11 Bit
Reference to firmware/stack version	V3.6.x.x

Table 136: Technical Data CANopen Slave Protocol

10.4.18 DeviceNet Master

Parameter	Description
Maximum number of DeviceNet slaves	63
Maximum number of total cyclic input data	3584 bytes
Maximum number of total cyclic output data	3584 bytes
Maximum number of cyclic input data	255 bytes/connection
Maximum number of cyclic output data	255 bytes/connection
Maximum Configuration data	1000 bytes/slave
Acyclic communication	Explicit connection All service codes are supported
Connections	Bit Strobe Change of State Cyclic Poll Explicit Peer-to-Peer Messaging
Function	Quick Connect
Fragmentation	Explicit and I/O
UCMM	Supported
Objects	Identity Object (Class Code 0x01) Message Router Object (Class Code 0x02) DeviceNet Object (Class Code 0x03) Connection Object (Class Code 0x05) Acknowledge Handler Object (Class Code 0x06)
Baud rates	125 kBits/s, 250 kBit/s, 500 kBit/s Auto baudrate detection is not supported
Data transport layer	CAN frames
Reference to firmware/stack version	V2.3.x.x

Table 137: Technical Data DeviceNet Master Protocol

10.4.19 DeviceNet Slave

Parameter	Description
Maximum number of cyclic input data	255 bytes
Maximum number of cyclic output data	255 bytes
Acyclic communication	Get_Attribute_Single/All Max. 240 bytes per request Set_Attribute_Single/All Max. 240 bytes per request
Connections	Poll Change-of-state Cyclic Bit-strobe
Explicit messaging	Supported
Fragmentation	Explicit and I/O
UCMM	Not supported
Baud rates	125 kBits/s, 250 kBit/s, 500 kBit/s Auto baudrate detection is not supported
Data transport layer	CAN frames
Reference to firmware/stack version	V2.3.x.x

Table 138: Technical Data DeviceNet Slave Protocol

10.4.20 AS-Interface Master

Parameter	Description
Maximum number of supported slaves	Max. 62 slaves
Maximum number of total cyclic input data	Max. 248 bits using digital slaves Max. 248 bytes using analog (transparent) slaves The maximum number depends on the used slave profiles
Maximum number of total cyclic output data	Max. 248 bits using digital slaves Max. 248 bytes using analog (transparent) slaves The maximum number depends on the used slave profiles
Maximum number of cyclic input data	Max. 4 Bit digital data Max. 4 channel with up to 16 bit analog data The maximum number depends on the used slave profiles
Maximum number of cyclic output data	Max. 4 Bit digital data Max. 4 channel with up to 16 bit analog data The maximum number depends on the used slave profiles
Parameterization data	4 bit per standard slave 3 bit per extended slave
Maximum number of acyclic read/write	Max. 220 bytes for string transfer
Functions	Support of data exchange via combined transaction types 1, 2, 3, 4 and 5 (CTT 1-5) Automatic address assignment Modification of address and Extended ID1-Code of Slave supported Profile for extended Master: M4
Baud rate	166,67 kBaud
AS-Interface specification	3.0 Revision 2
Limitations	'Synchronous Data I/O Mode' not supported
Reference to firmware/stack version	V2.3.x.x

Table 139: Technical Data AS-Interface Master Protocol

10.4.21 CC Link Slave

Parameter	Description
Firmware works according to CC-Link Version 2.0:	
Station Types	Remote Device Station (up to 4 occupied stations)
Maximum input data	368 bytes
Maximum output data	368 bytes
Input data remote device station	112 bytes (RY) and 256 bytes (RWw)
Output data remote device station	112 bytes (RX) and 256 bytes (RWr)
Extension cycles	1, 2, 4, 8
Baud rates	156 kBit/s, 625 kBit/s, 2500 kBit/s, 5 MBit/s, 10 MBit/s
Limitation	Intelligent Device Station not supported
Firmware works according to CC-Link Version 1.11:	
Station Types	Remote I/O station, Remote device station' (up to 4 occupied stations)
Maximum input data	48 bytes
Maximum output data	48 bytes
Input data remote I/O station	4 bytes (RY)
Output data remote I/O station	4 bytes (RX)
Input data remote device station	4 bytes (RY) and 8 bytes (RWw) per occupied station
Output data remote device station	4 bytes (RX) and 8 bytes (RWr) per occupied station
Baud rates	156 kBit/s, 625 kBit/s, 2500 kBit/s, 5 MBit/s, 10 MBit/s
Firmware	
Reference to firmware/stack version	V2.9.x.x

Table 140: Technical Data CC-Link-Slave Protocol

11 Annex

11.1 Device Label with Matrix Code

You can identify your device by means of the device label.



Note: The position of the device label on your device can be seen from the device drawing.

The device label consists of a matrix code and the information contained therein in plain text.

The 2 D code (Data Matrix Code) contains the following information:

- ① Part number: 1234.567
- ② Hardware revision: 1
- ③ Serial number: 20000 (for mini matrix 20001)

The device label with matrix code can be designed as mini-sticker.

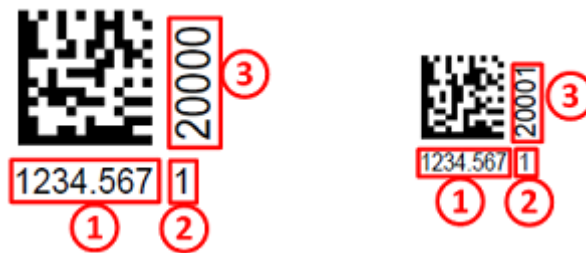

Figure 55: Example 2D Label (mini sticker on the right)

11.2 Tolerances of the shown Card Dimensions

The manufacturing tolerance of the printed circuit boards of the PC card cifX is ± 0.1 mm per milled PCB edge. For all dimensions of the PCB indicated on the drawings (in the sections *Dimensions PC Cards cifX PCI* and *PCI Express* from page 174 and *Dimensions PC Cards cifX Low Profile PCI Express* from page 199) thus results for the length L and the width W, a tolerance of ± 0.1 mm (per milled edge) $\times 2 = \pm 0.2$ mm.

$$W = [\text{width of the board in mm}] \pm 0.2 \text{ mm}$$

$$L = [\text{length of the board in mm}] \pm 0.2 \text{ mm}$$

The depth T of the PCB depends on the highest part used or the circuit board plus the descenders. The thickness of the PCB is $= 1.6 \text{ mm} \pm 10\%$.



Note: The dimensions (L x W x D) specified in section *Technical Data PC Cards cifX* on page 116 (and also the identical values in the data sheet cifX and on the 'Hilscher Site') are rounded and unified for the respective types of card. Here the depth of the PC cards PCI (CIFX 50), PCI Express (CIFX 50E) or Low Profile PCI Express (CIFX 70E) has been equated to the rounded width of the front panel.

11.3 Dimensions PC Cards cifX PCI and PCI Express

11.3.1 CIFX 50-RE, CIFX 50-RE1ET

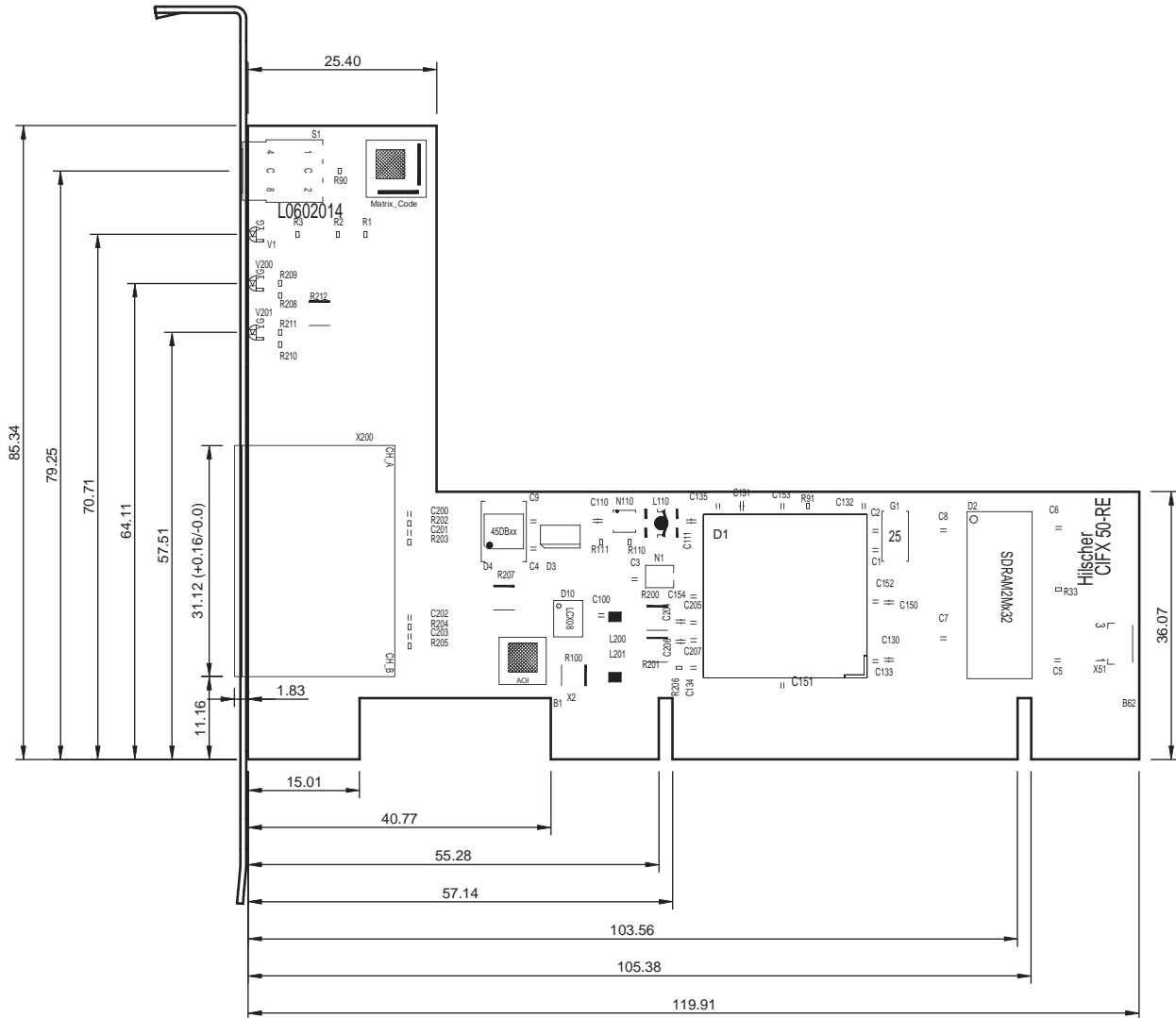

Figure 56: Dimensions CIFX 50-RE (from Hardware-Rev. 3), CIFX 50-RE1ET (from Hardware-Rev. 1)

11.3.2 CIFX 50E-RE, CIFX 50E-RE\ET

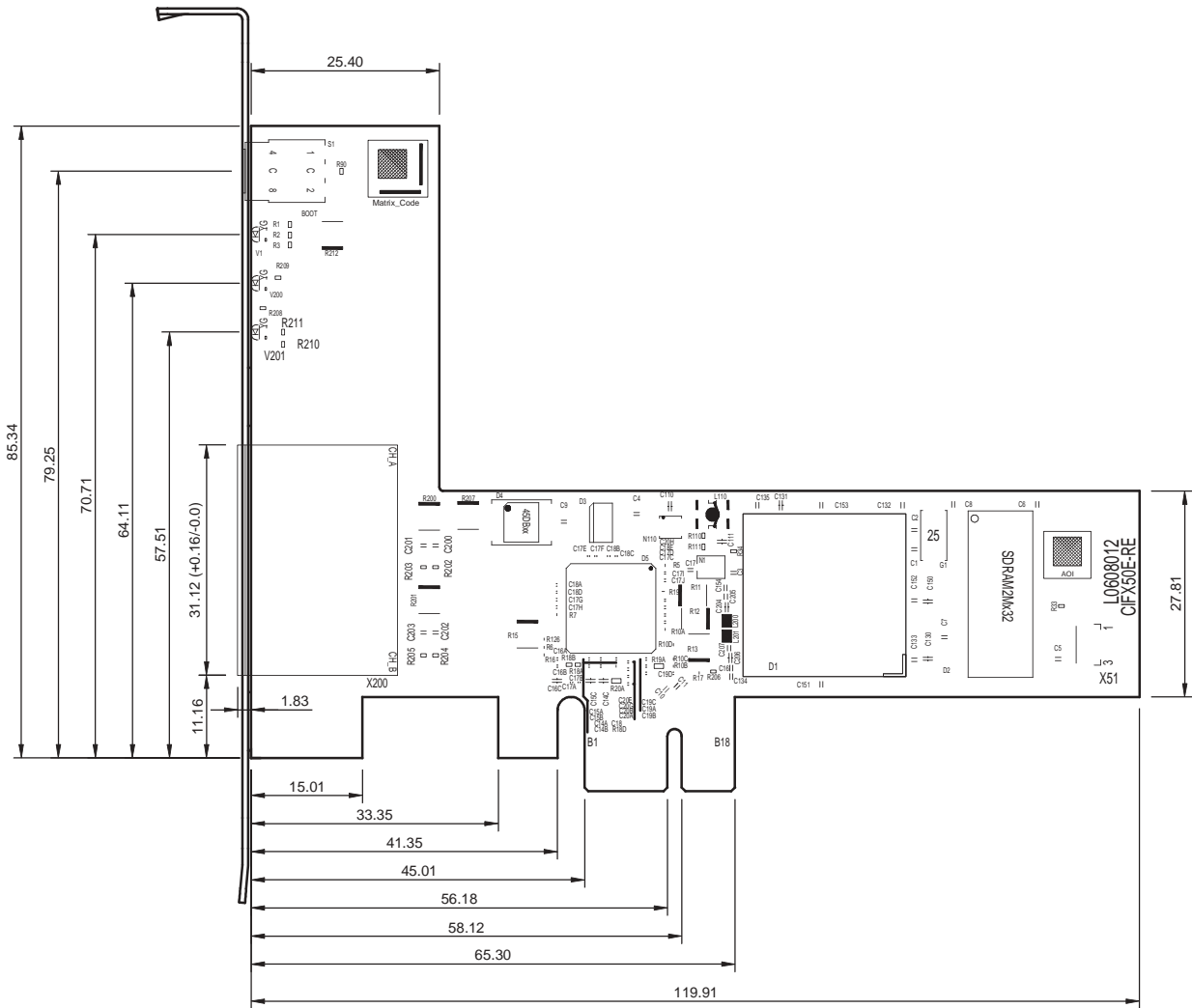

Figure 57: Dimensions CIFX 50E-RE (from Hardware-Rev. 4), CIFX 50E-RE\ET (from Hardware-Rev. 1)

11.3.3 Front Panel CIFX 50-RE, CIFX 50-RE\ET, CIFX 50E-RE or CIFX 50E-RE\ET

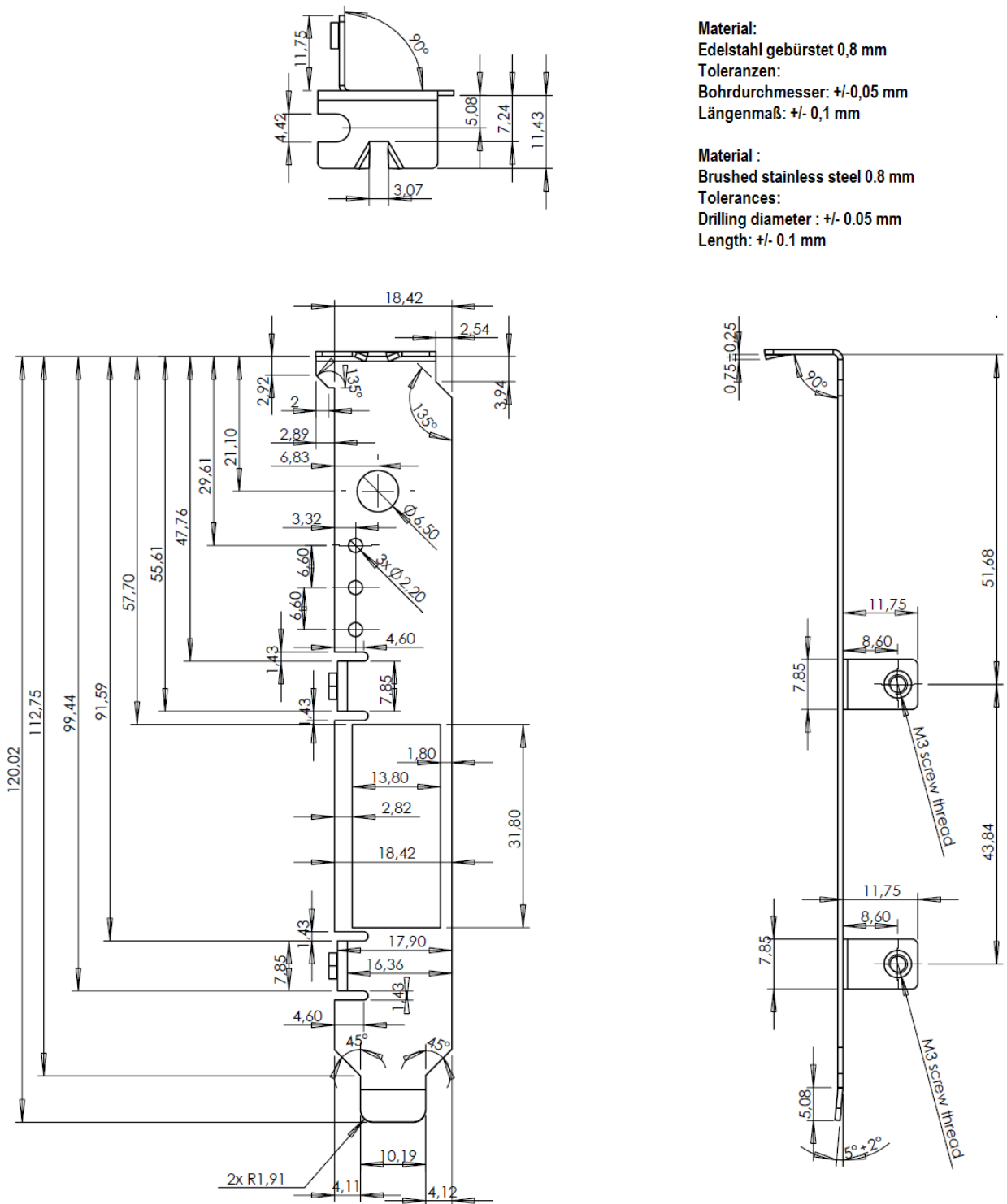

Figure 58: Dimensions Front Panel CIFX 50-RE, CIFX 50-RE\ET, CIFX 50E-RE or CIFX 50E-RE\ET

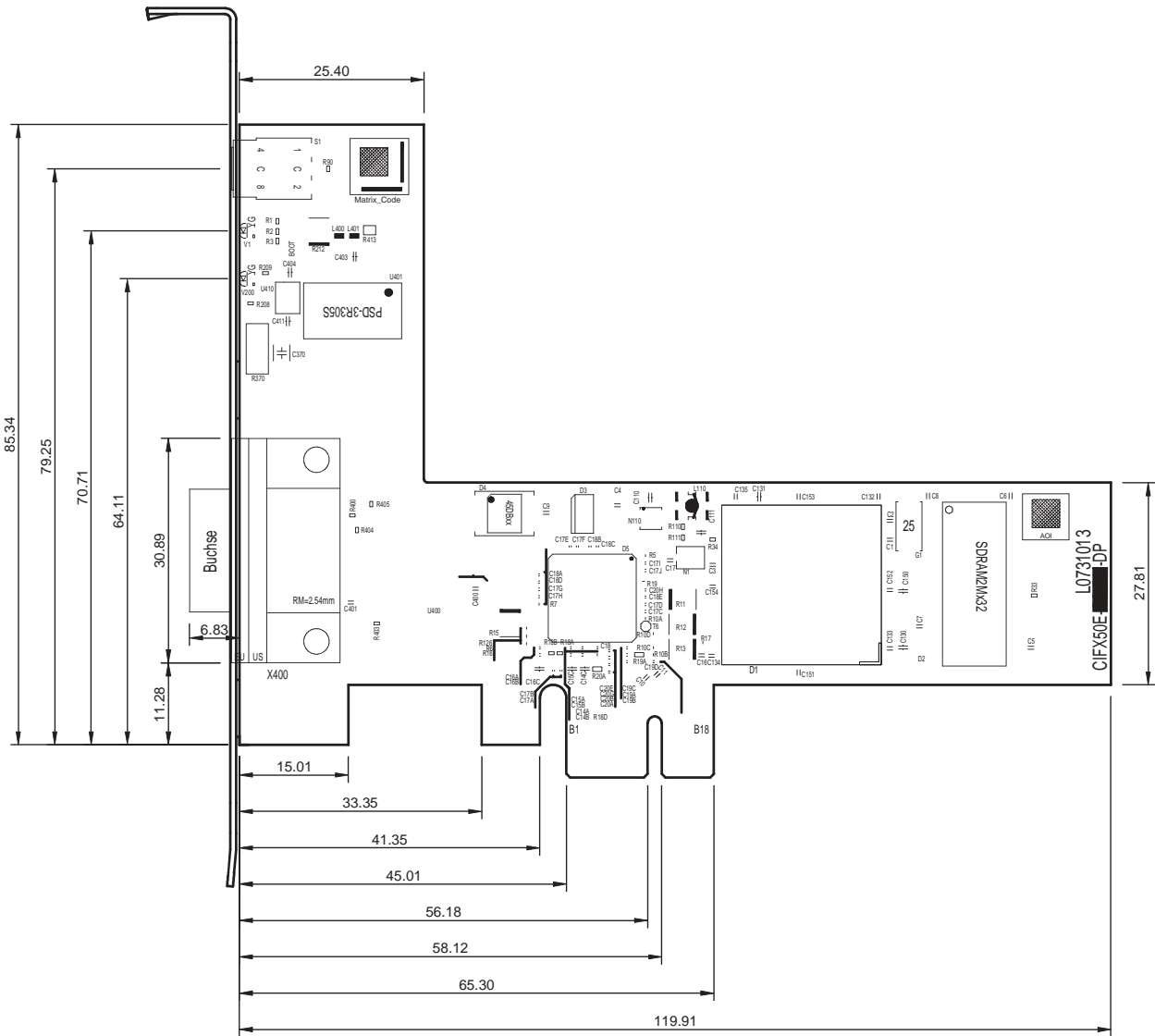

Figure 60: Dimensions CIFX 50E-DP (Hardware-Rev. 6)

11.3.6 CIFX 50-CO, CIFX 50E-CO

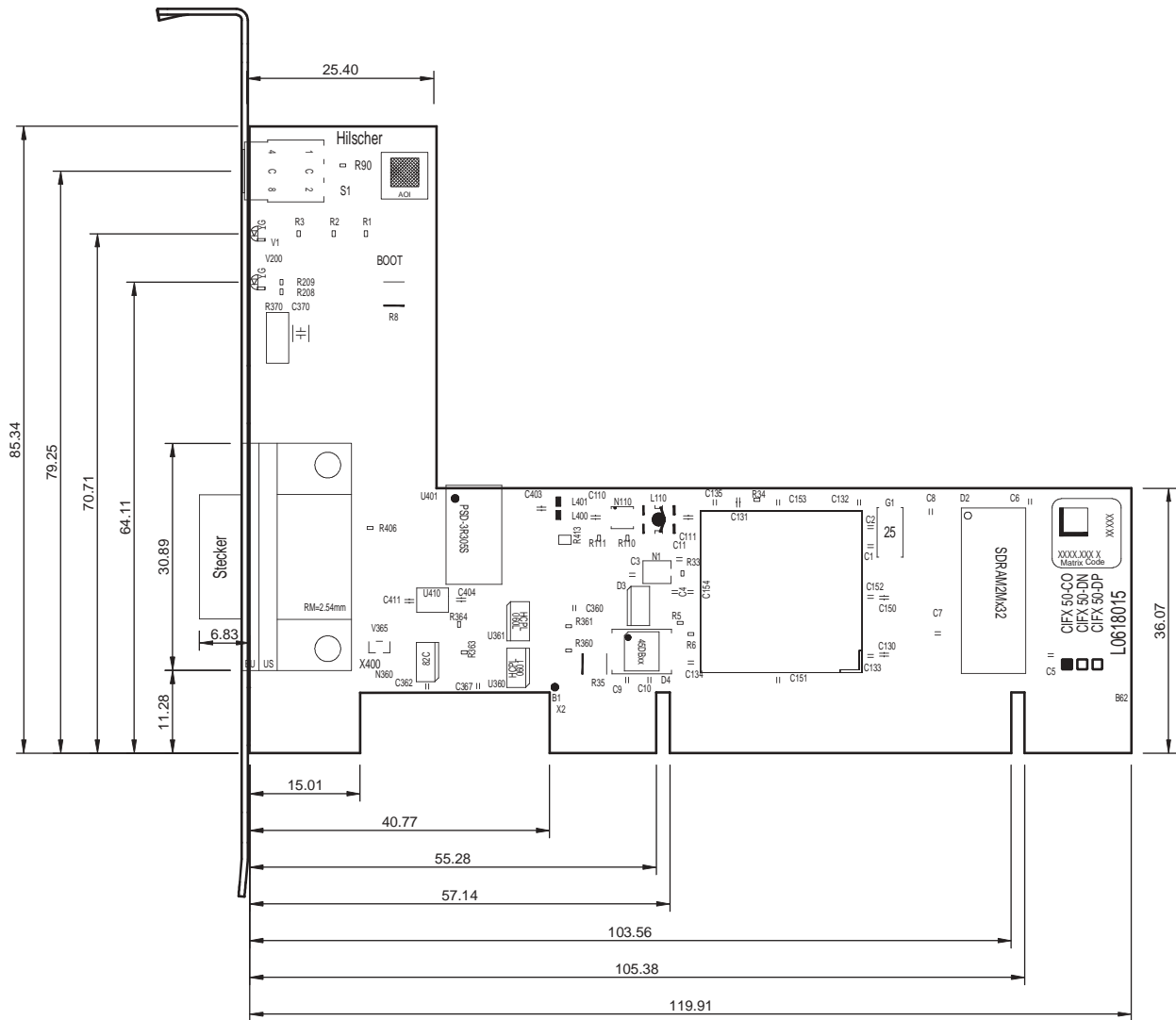

Figure 62: Dimensions CIFX 50-CO (Hardware-Rev. 5)

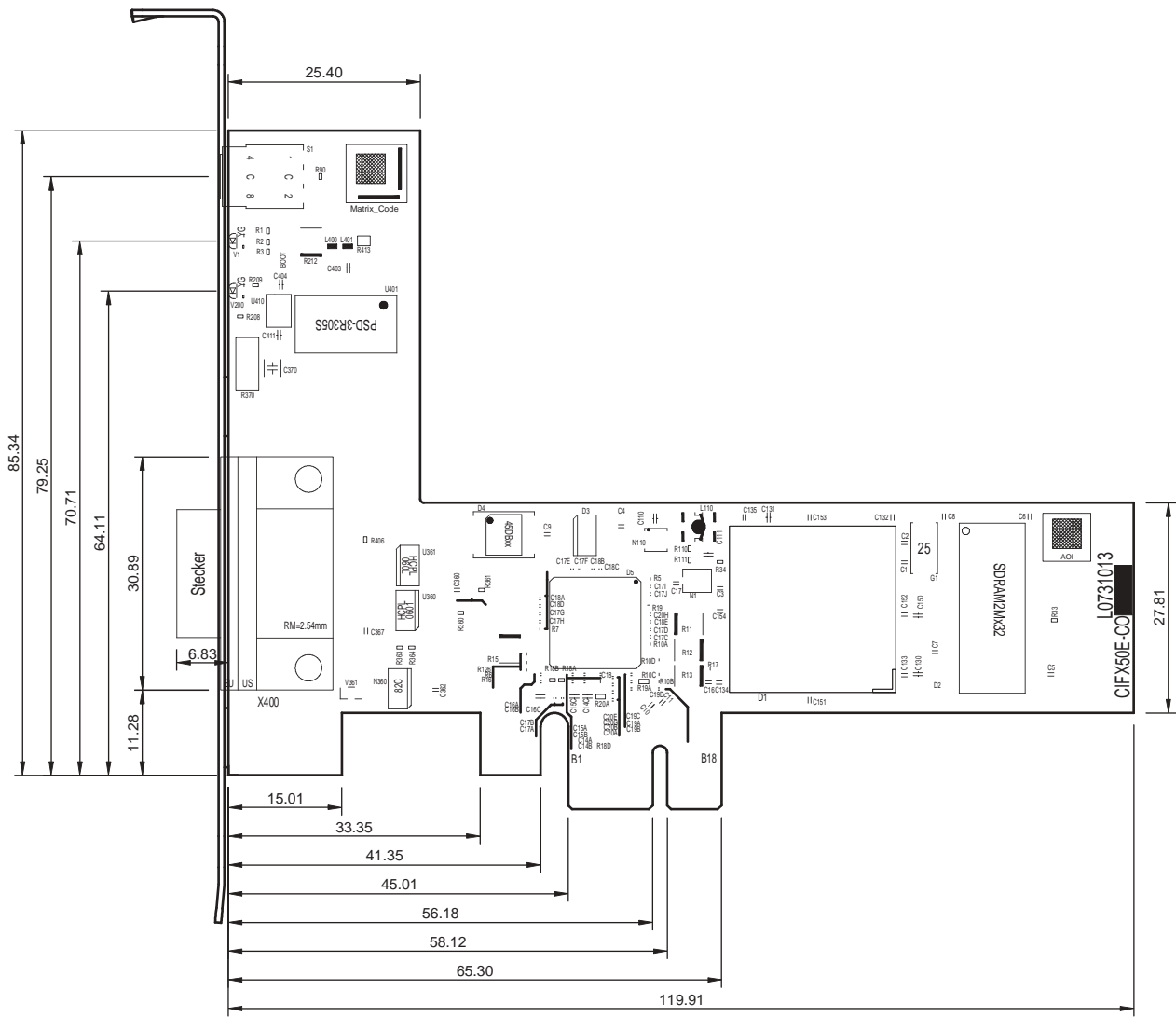

Figure 63: Dimensions CIFX 50E-CO (from Hardware-Rev. 4)

11.3.8 CIFX 50-DN, CIFX 50E-DN

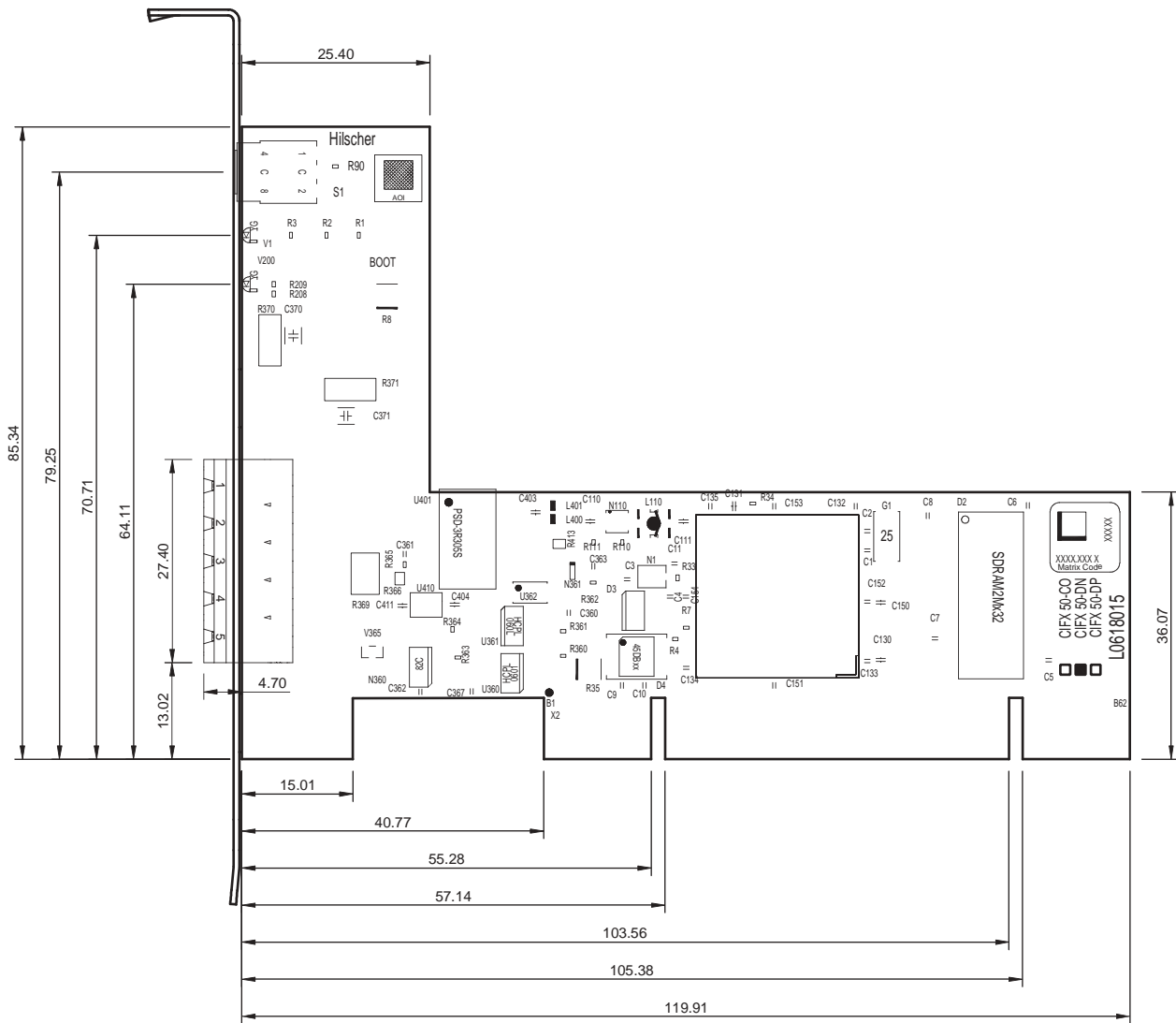

Figure 65: Dimensions CIFX 50-DN (Hardware-Rev. 5)

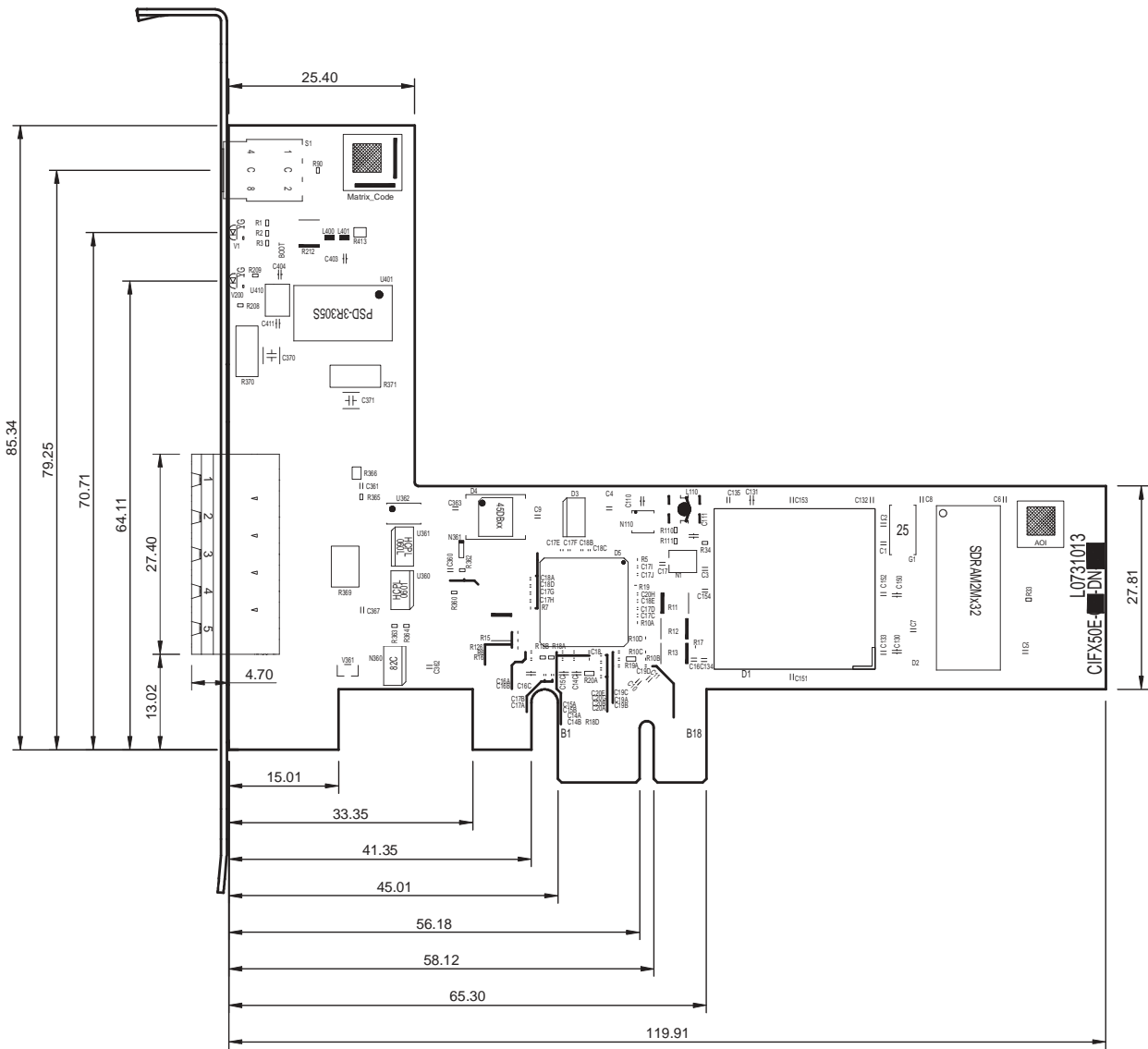

Figure 66: Dimensions CIFX 50E-DN (from Hardware-Rev. 4)

11.3.10 CIFX 50-CC, CIFX 50E-CC

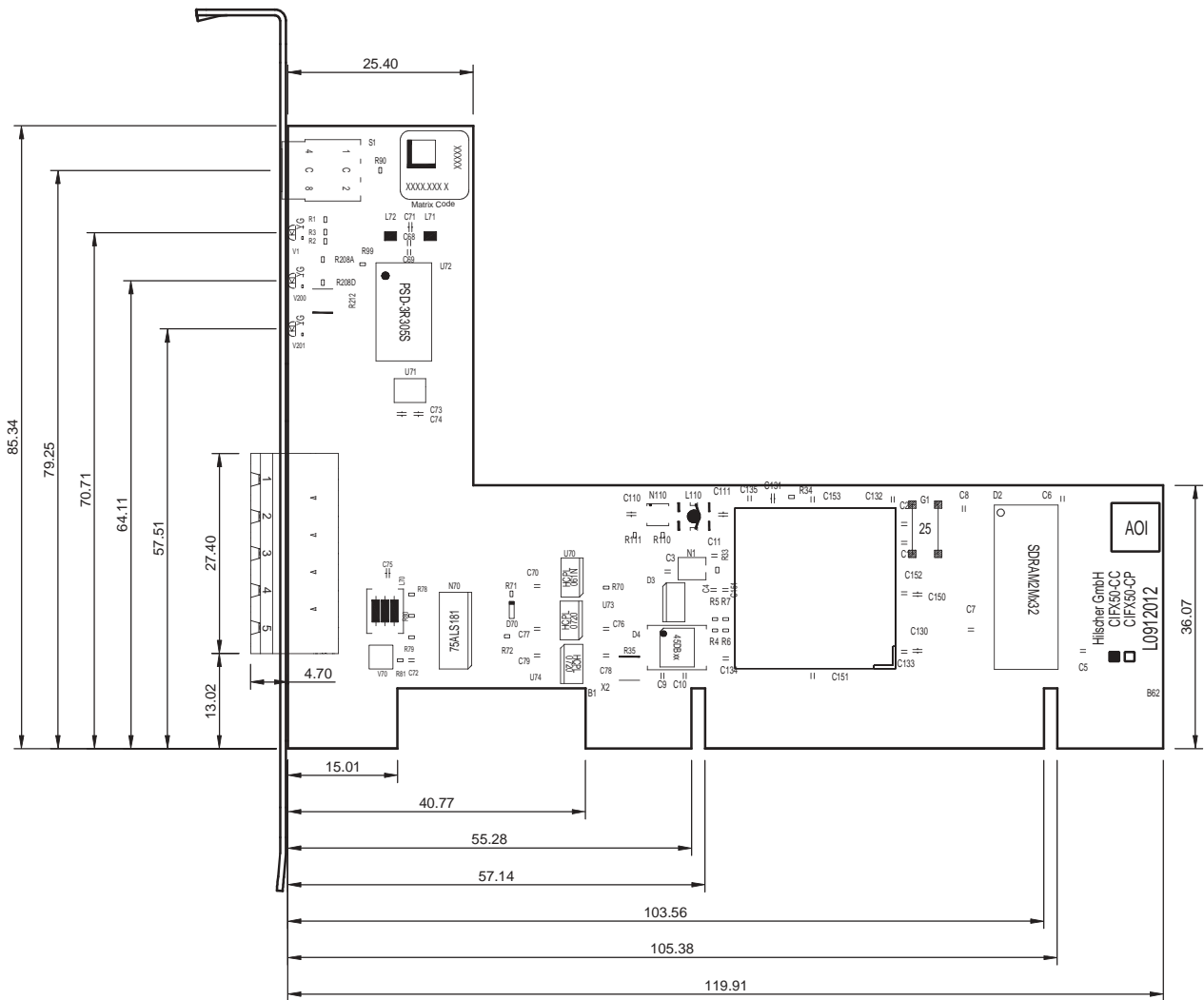

Figure 68: Dimensions CIFX 50-CC (Hardware-Rev. 2)

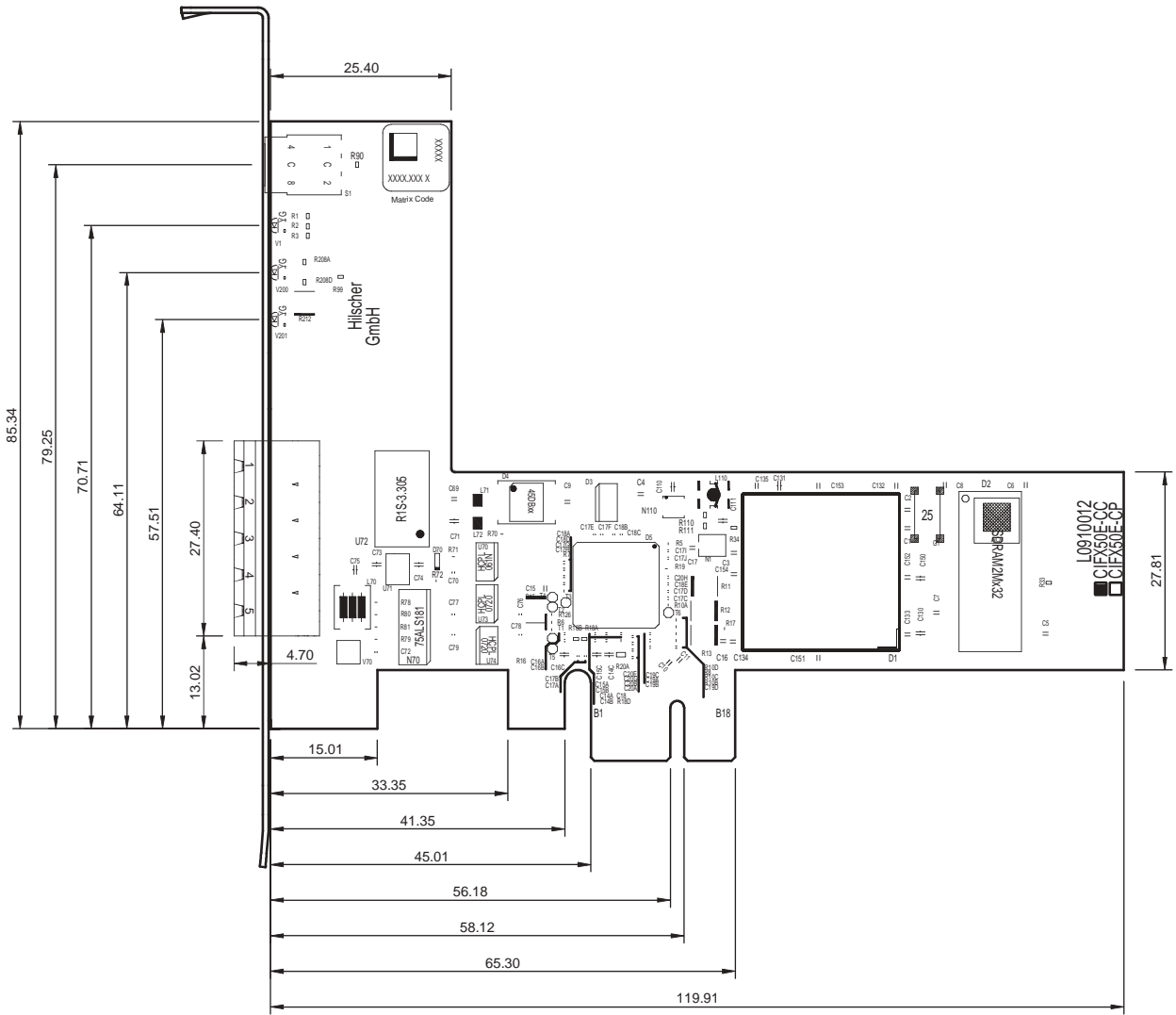
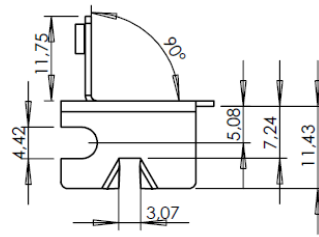

Figure 69: Dimensions CIFX 50E-CC (from Hardware-Rev. 4)

11.3.11 Front Panel CIFX 50-CC or CIFX 50E-CC



Material:
Edelstahl gebürstet 0,8 mm
Toleranzen:
Bohrdurchmesser: +/- 0,05 mm
Längenmaß: +/- 0,1 mm

Material :
Brushed stainless steel 0.8 mm
Tolerances:
Drilling diameter : +/- 0.05 mm
Length: +/- 0.1 mm

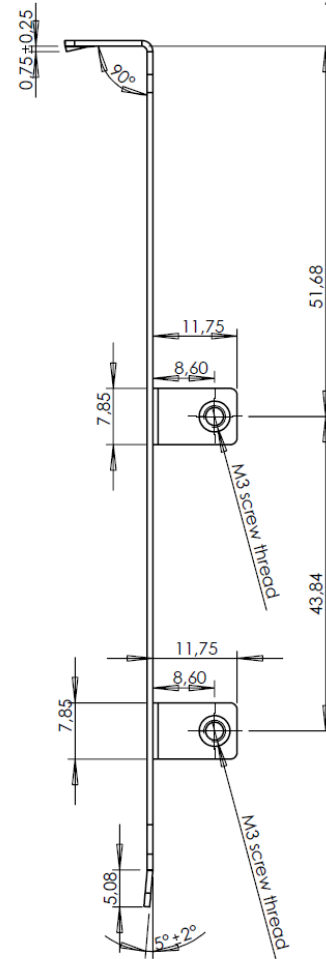
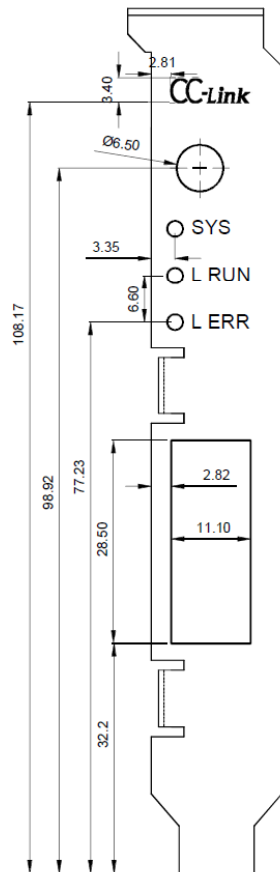

Figure 70: Dimensions Front Panel CIFX 50-CC or CIFX 50E-CC

11.3.12 CIFX 50-2DP

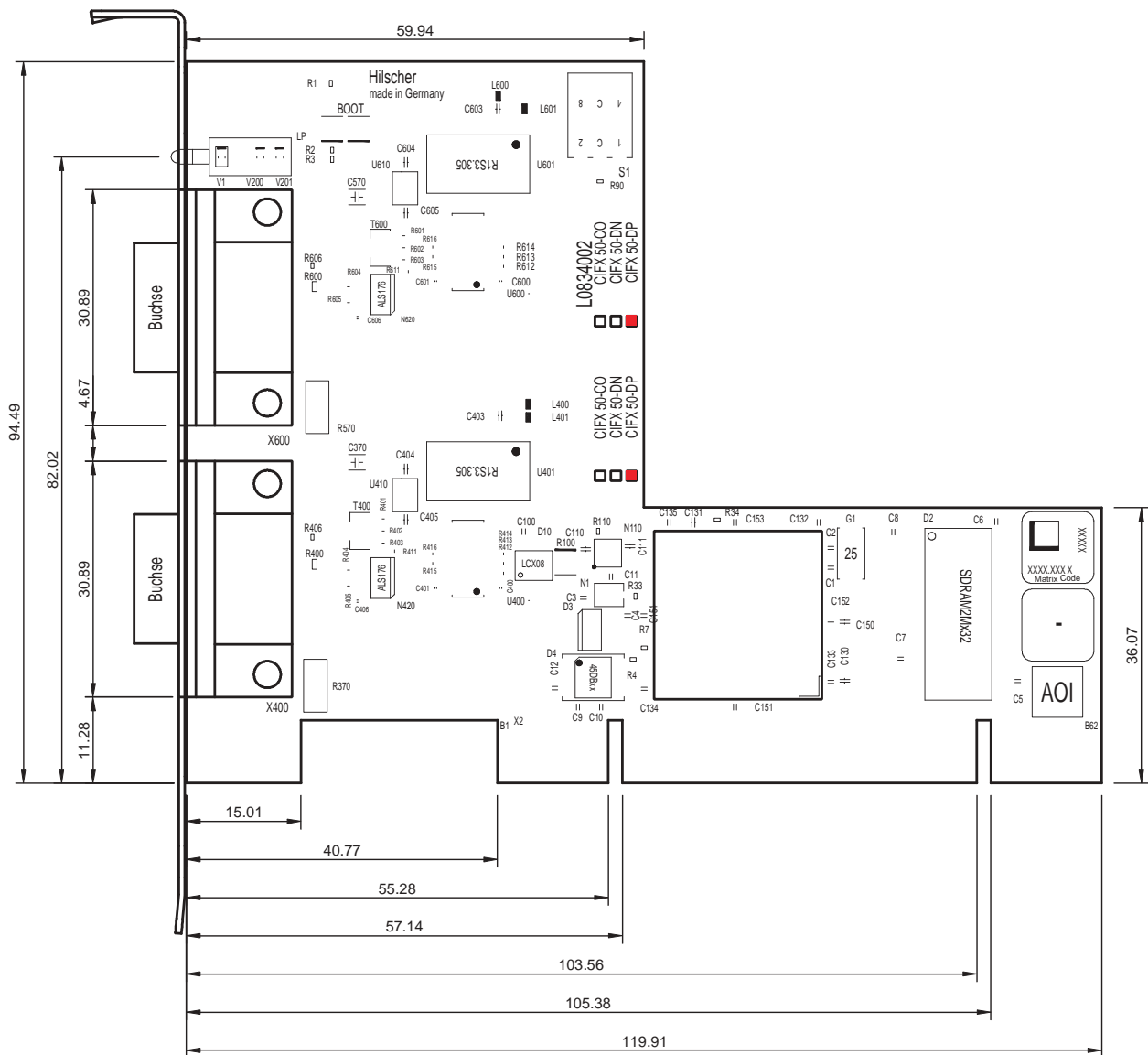

Figure 71: Dimensions CIFX 50-2DP (Hardware-Rev. 3)

11.3.13 CIFX 50-2DP\CO

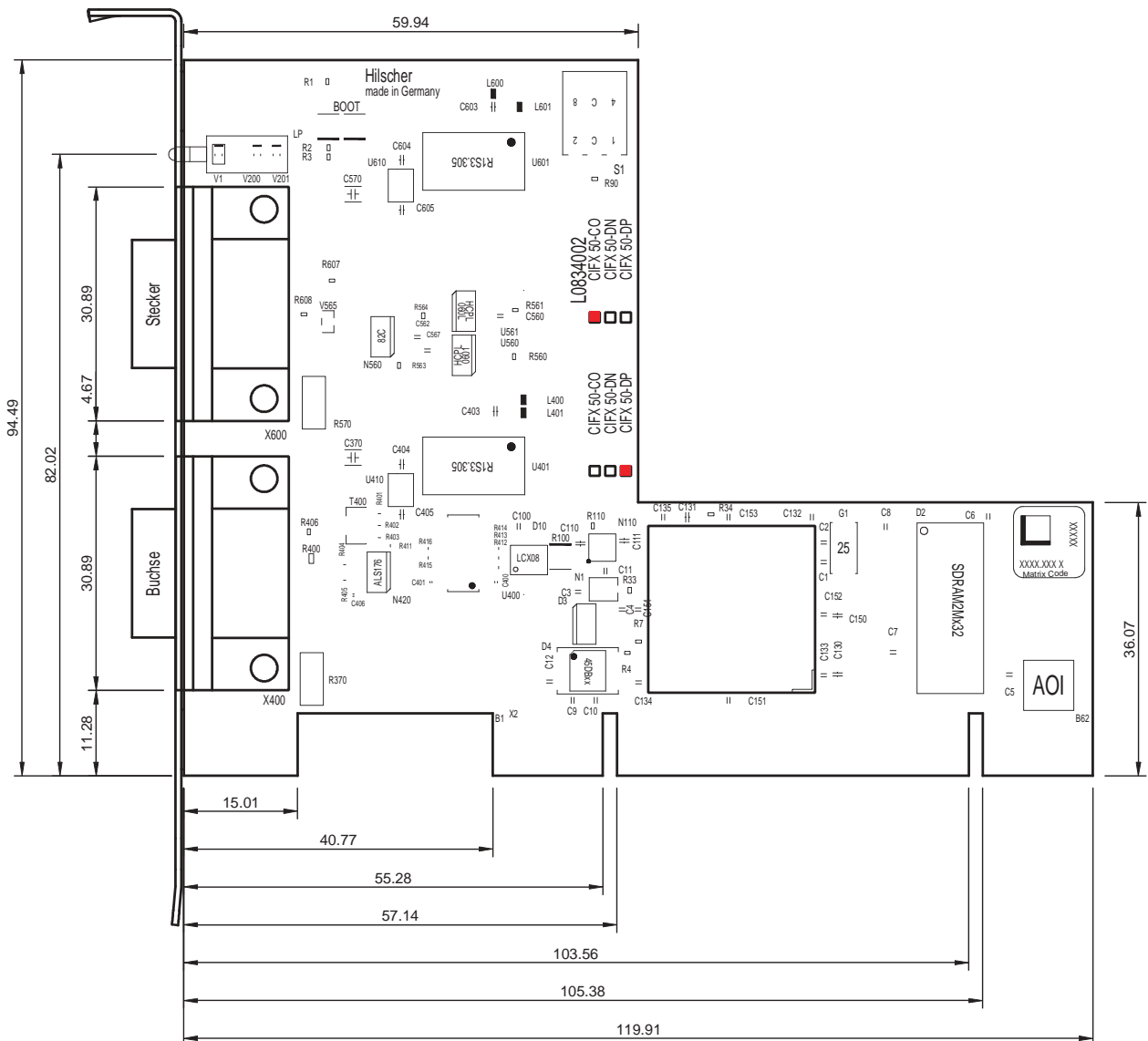

Figure 72: Dimensions CIFX 50-2DP\CO (Hardware-Rev. 2)

11.3.14 CIFX 50-2DP\DN

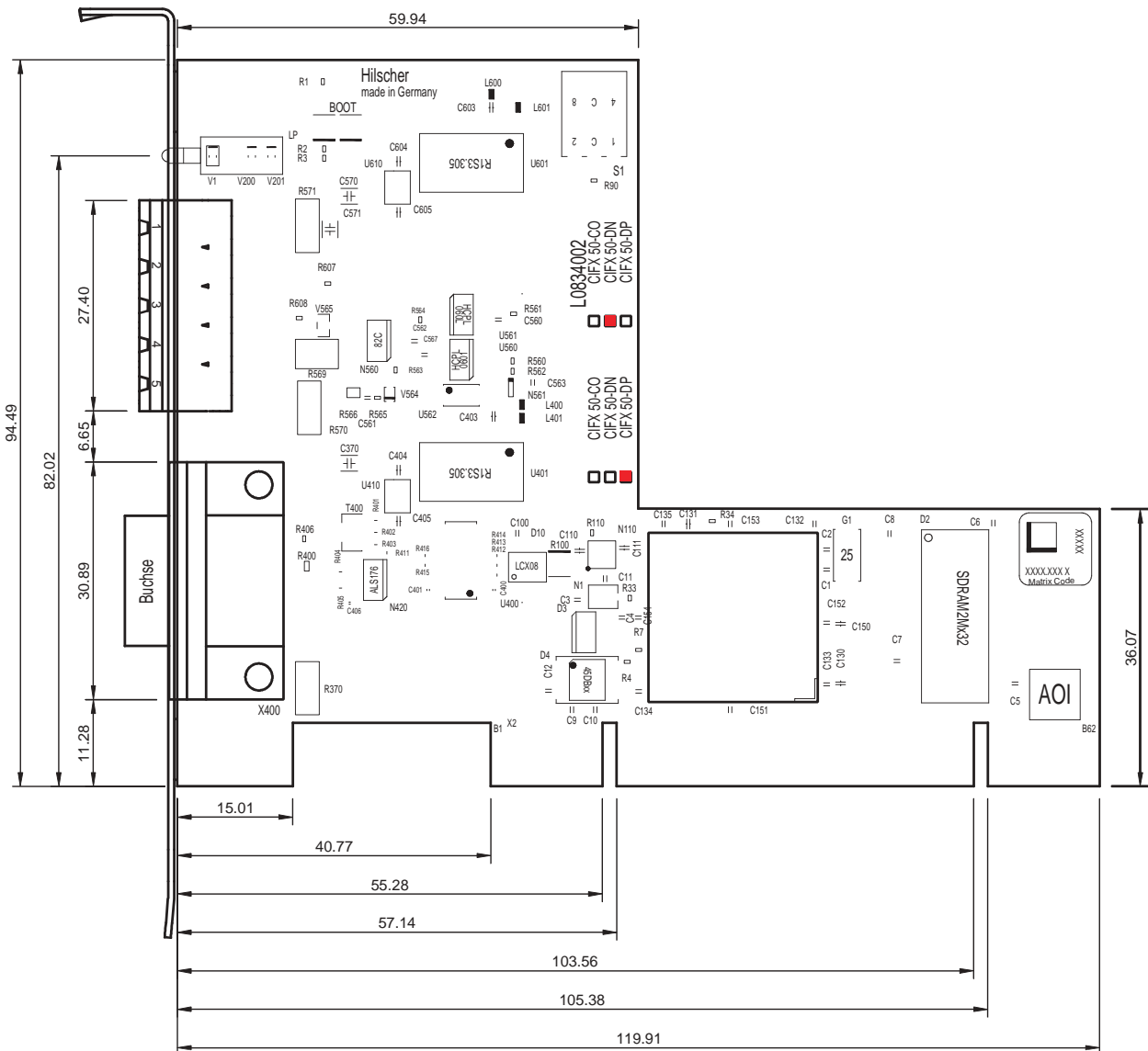

Figure 73: Dimensions CIFX 50-2DP\DN (Hardware-Rev. 1)

11.3.15 CIFX 50-2CO

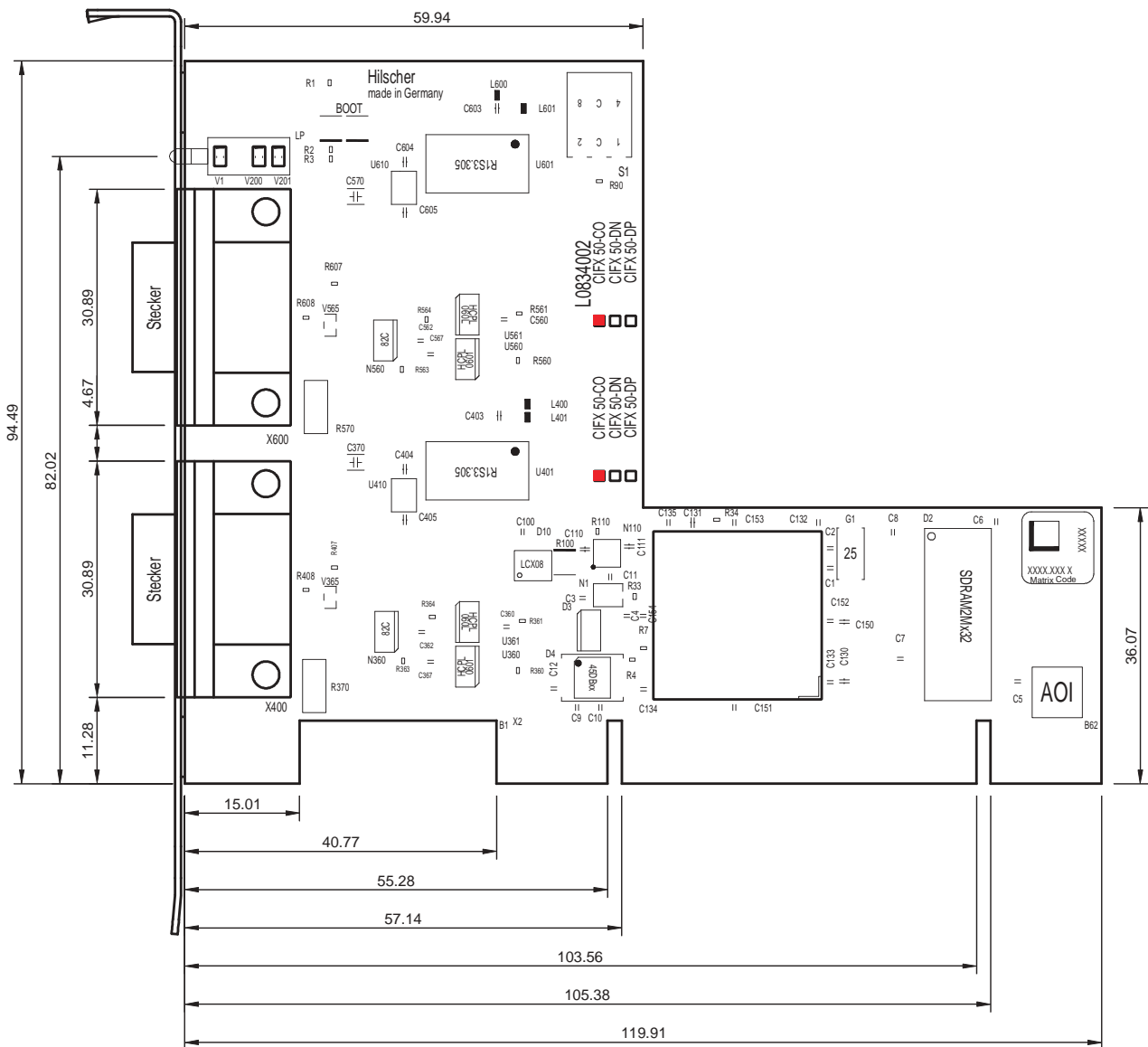

Figure 74: Dimensions CIFX 50-2CO (Hardware-Rev. 2)

11.3.16 CIFX 50-2CO\DN

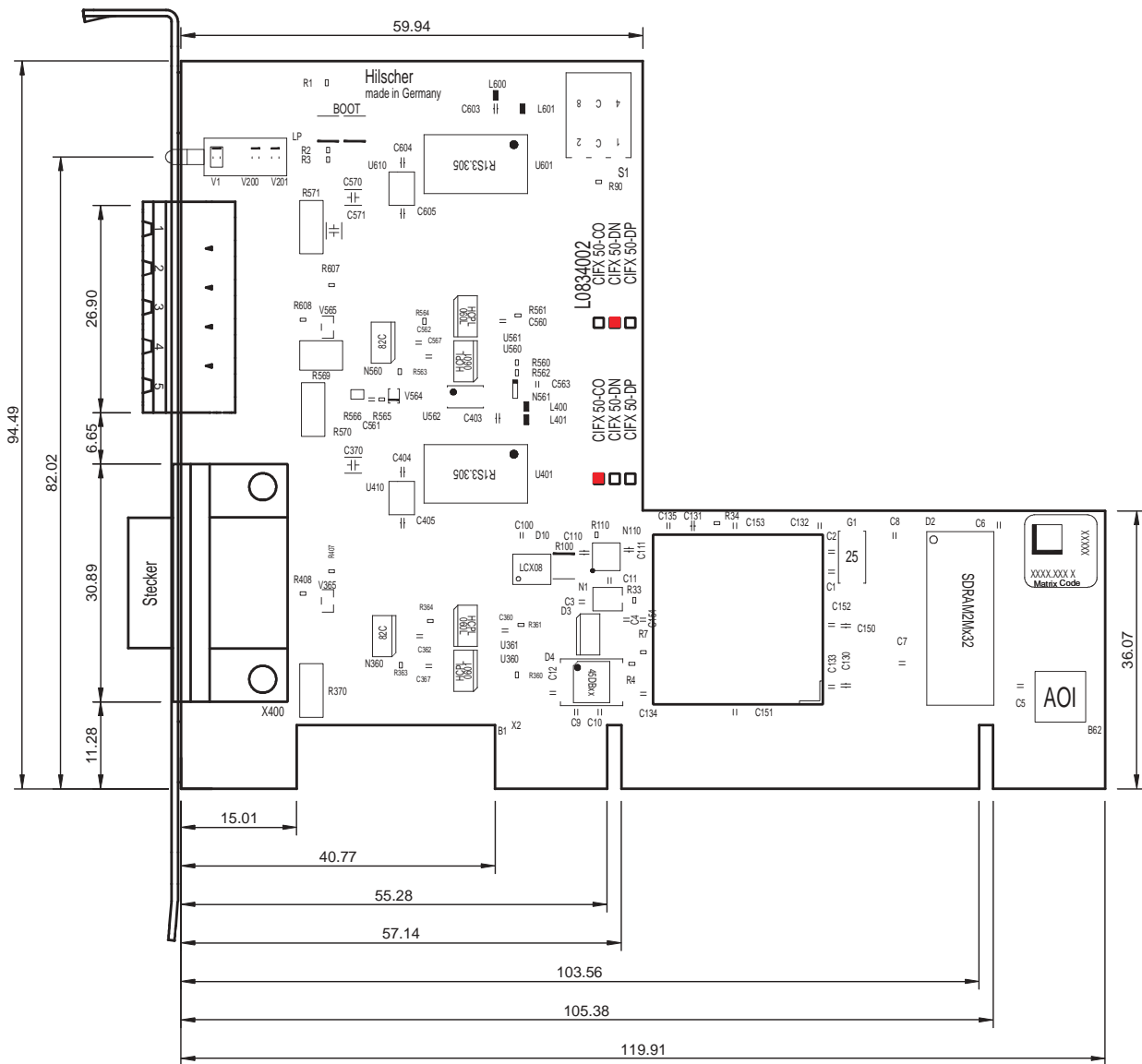

Figure 75: Dimensions CIFX 50-2CO\DN (Hardware-Rev. 1)

11.3.17 CIFX 50-2DN

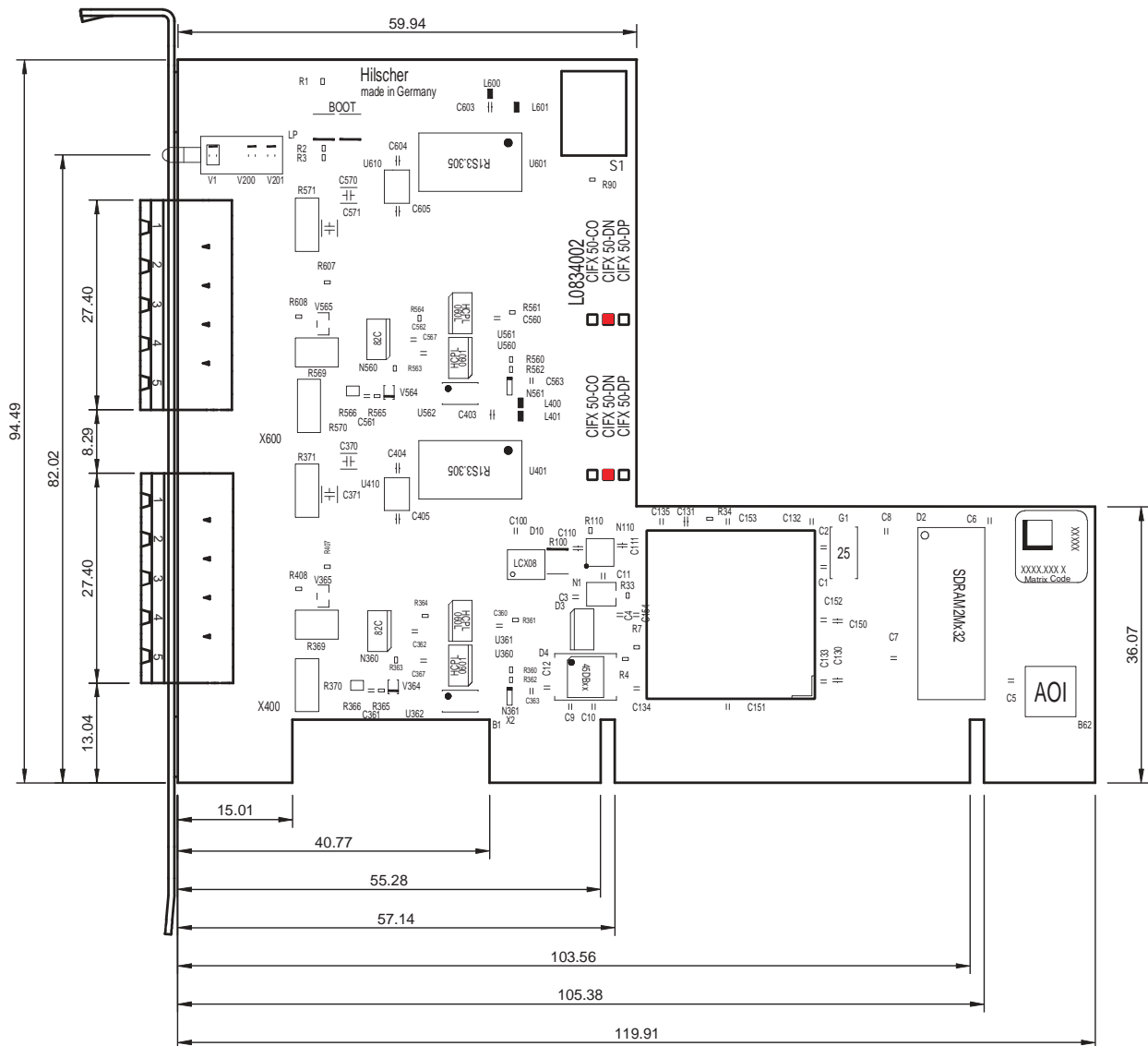

Figure 76: Dimensions CIFX 50-2DN (Hardware-Rev. 2)

11.3.18 Front Panel CIFX 50-2FB

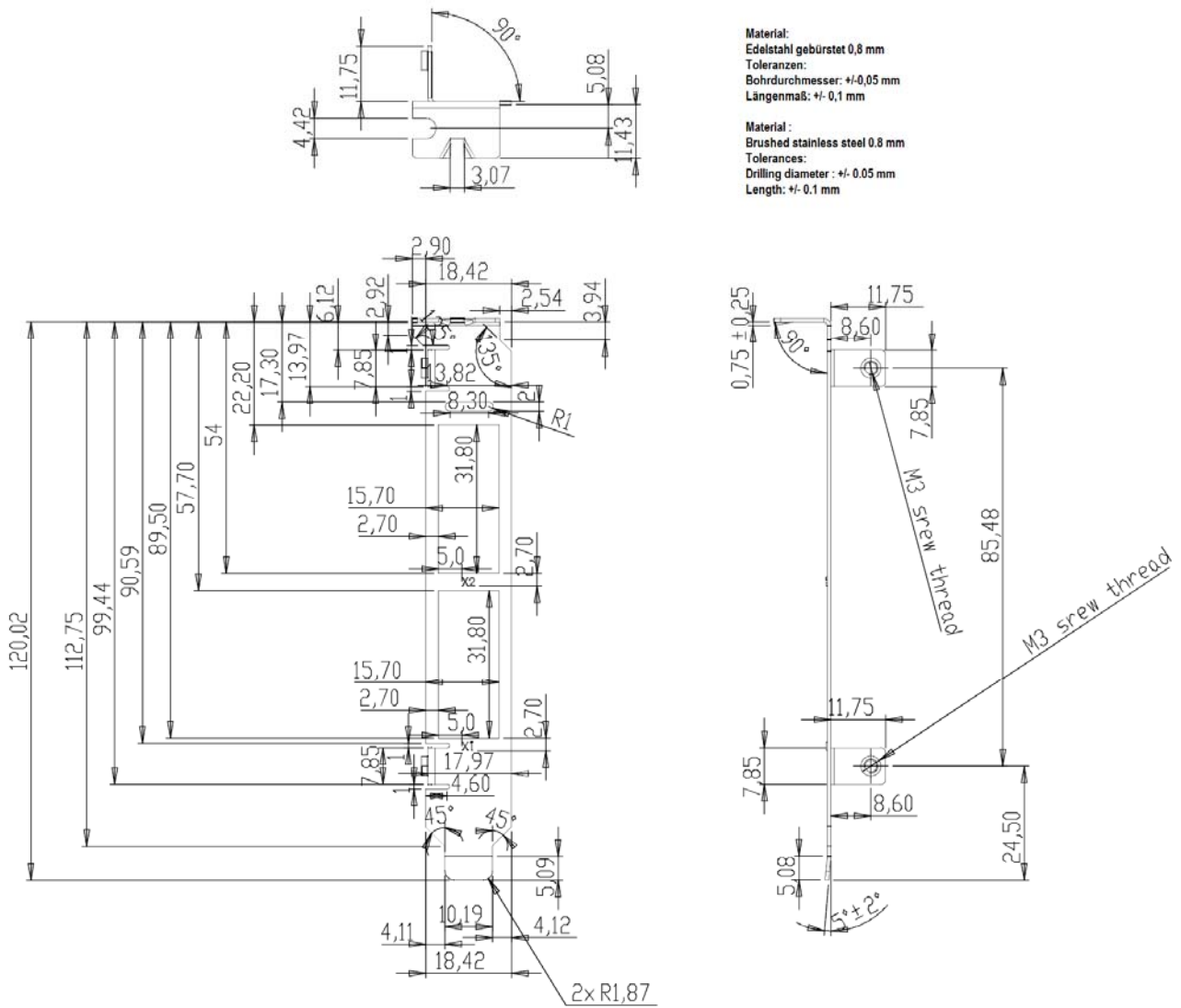

Figure 77: Dimensions Front Panel CIFX 50-2FB

11.3.19 CIFX 50-2ASM, CIFX 50E-2ASM

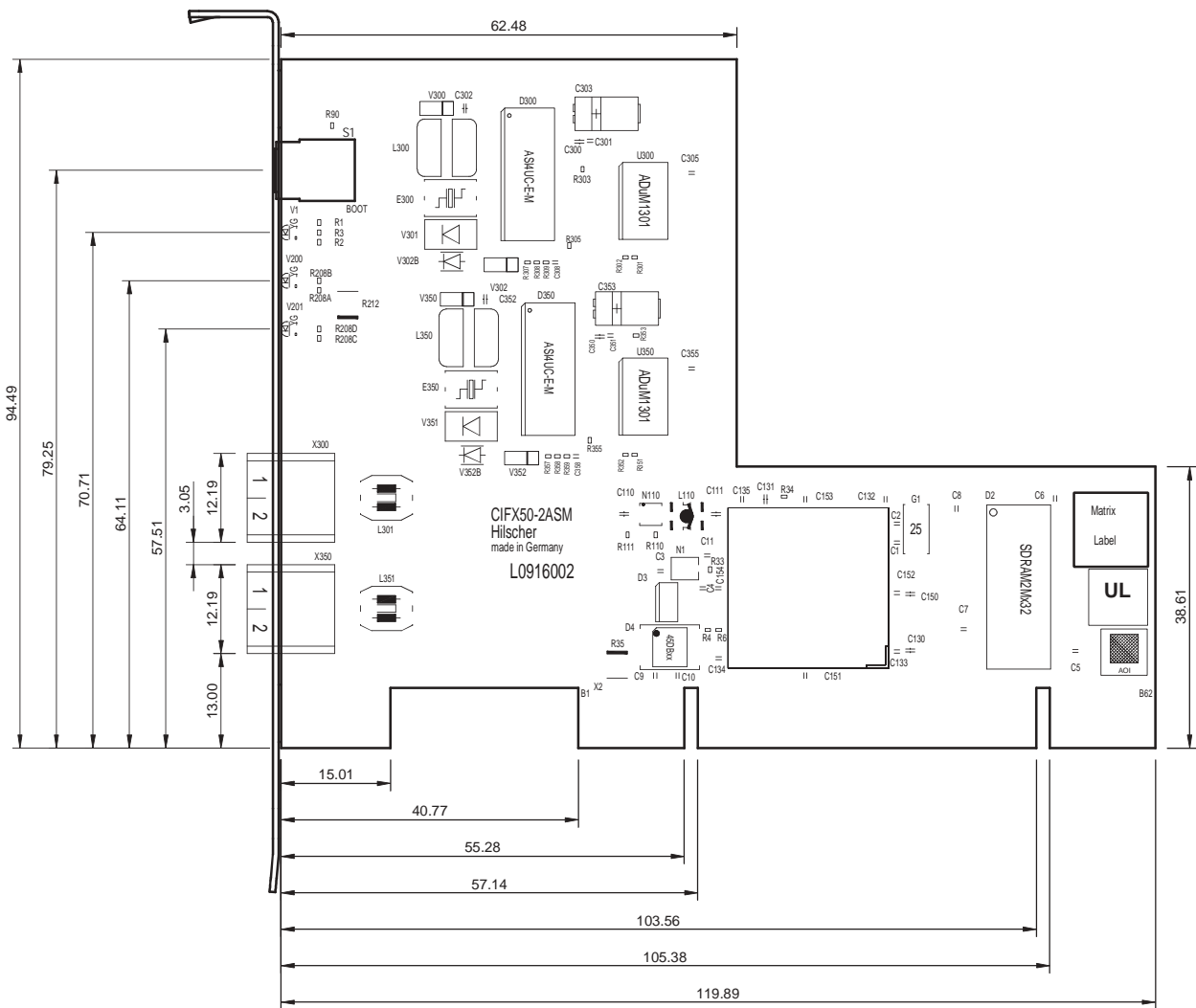
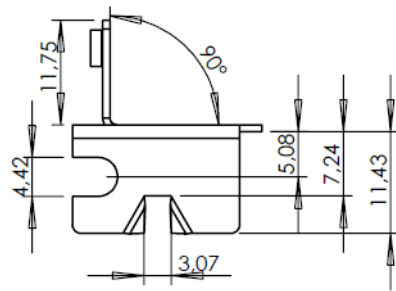

Figure 78: Dimensions CIFX 50-2ASM (Hardware-Rev. 2)

11.3.20 Front Panel CIFX 50-2ASM, CIFX 50E-2ASM



Material:
 Edelstahl gebürstet 0,8 mm
Toleranzen:
 Bohrdurchmesser: +/- 0,05 mm
 Längenmaß: +/- 0,1 mm

Material :
 Brushed stainless steel 0.8 mm
Tolerances:
 Drilling diameter : +/- 0.05 mm
 Length: +/- 0.1 mm

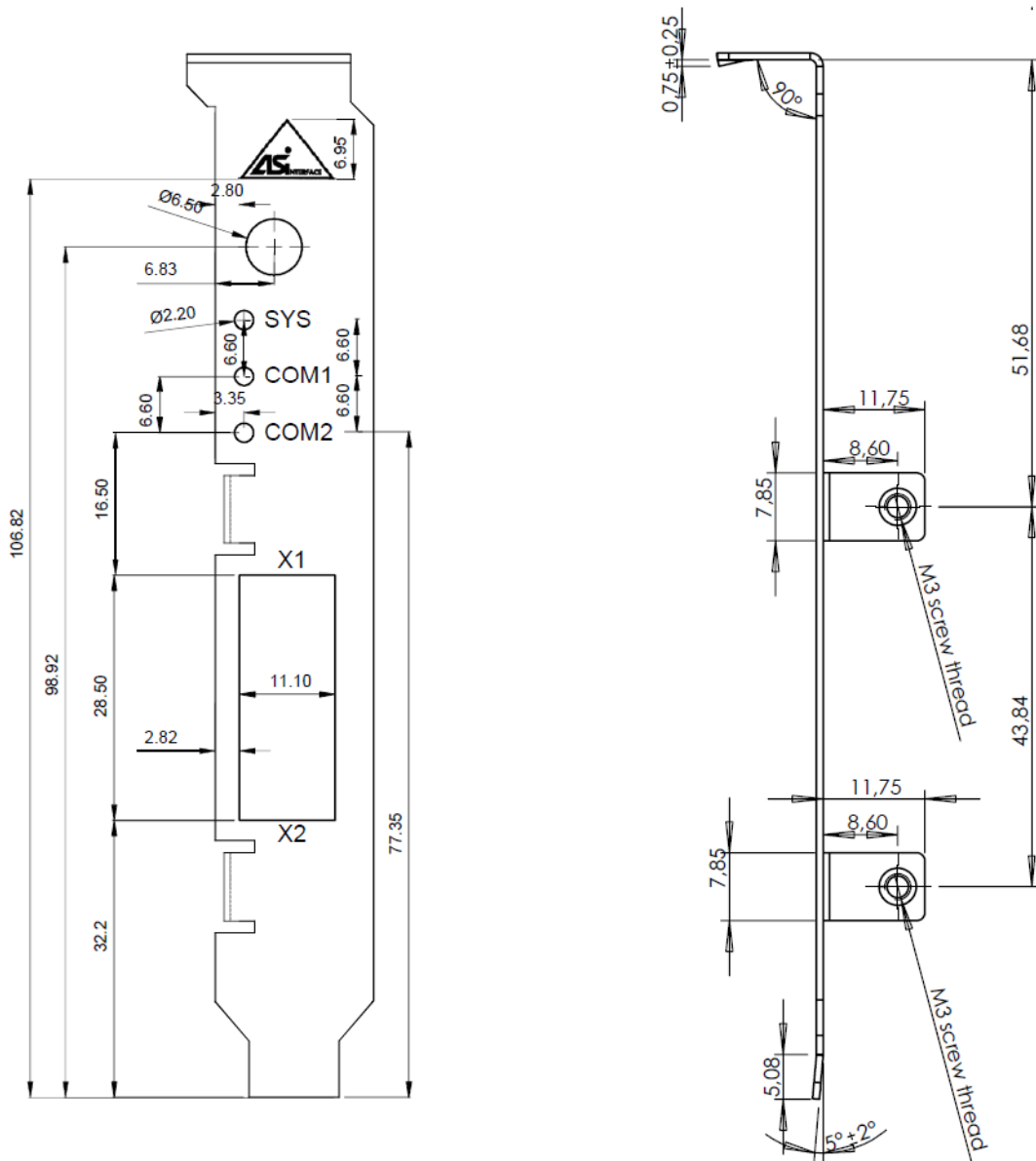

Figure 80: Dimensions Front Panel CIFX 50-2ASM, CIFX 50E-2ASM

11.4 Dimensions PC Cards cifX Low Profile PCI Express

11.4.1 CIFX 70E-RE, CIFX 70E-RE\MR

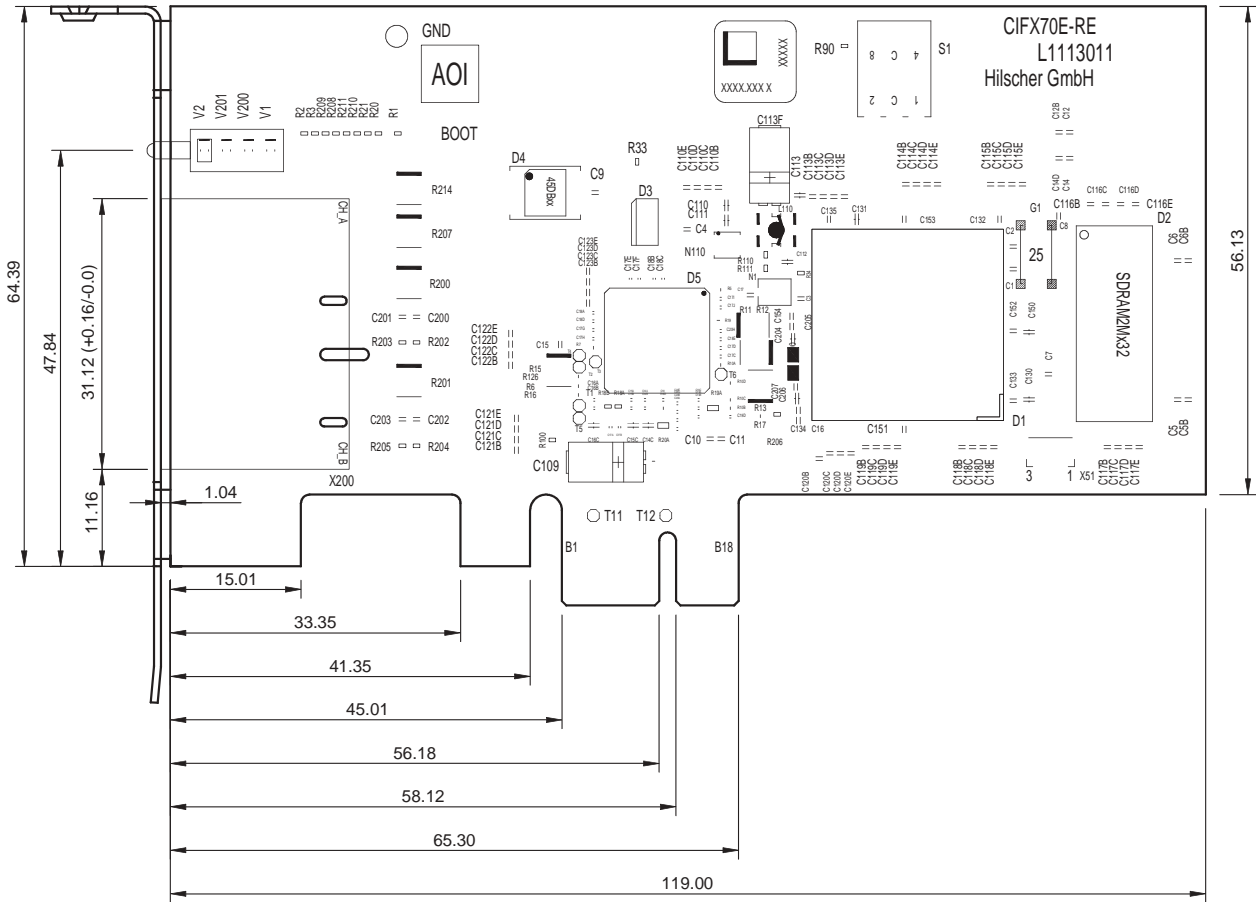

Figure 81: Dimensions CIFX 70E-RE and CIFX 70E-RE\MR (Hardware-Rev. 1)

11.4.2 Front Panel CIFX 70E-RE, CIFX 70E-RE\MR

Material:
Edelstahl gebürstet 0,8 mm
Toleranzen:
Bohrdurchmesser: +/- 0,05 mm
Längenmaß: +/- 0,01 mm

Material:
Brushed stainless steel 0.8 mm
Tolerances:
Drilling diameter: +/- 0.05 mm
Length: +/- 0.01 mm

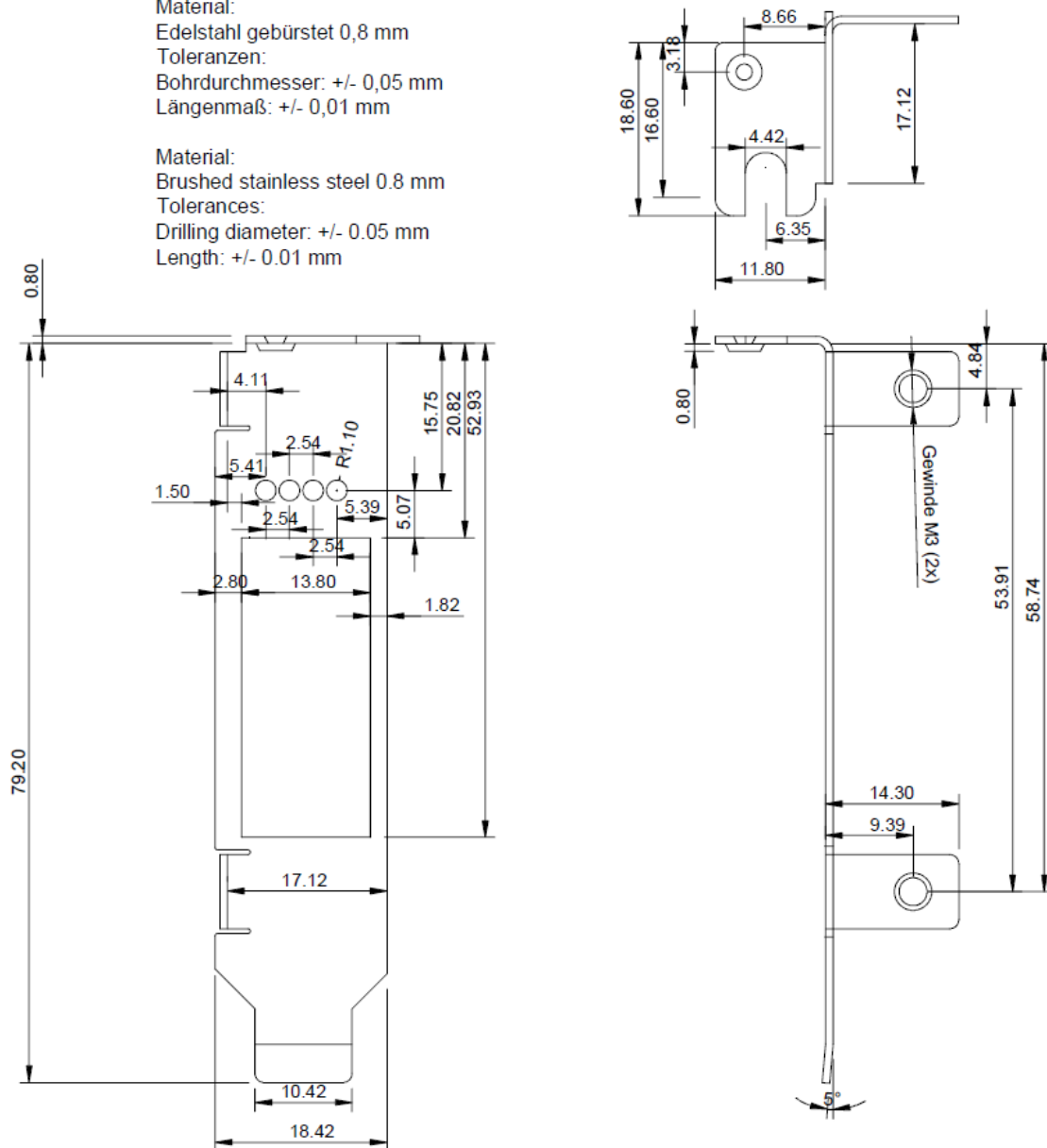

Figure 82: Dimensions Front Panel für CIFX 70E-RE, CIFX 70E-RE\MR

11.4.3 CIFX 70E-DP, CIFX 70E-DP\MR

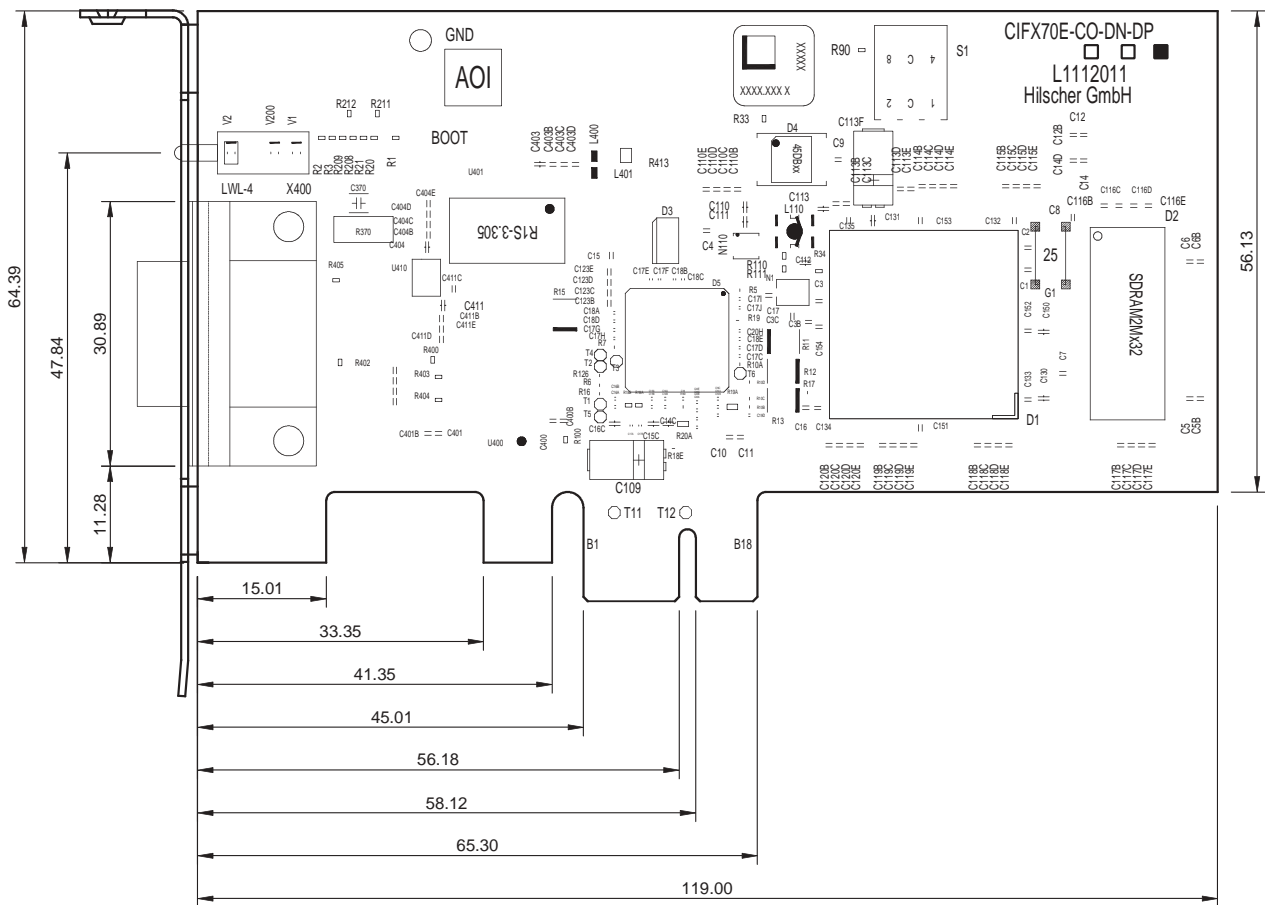

Figure 83: Dimensions CIFX 70E-DP and CIFX 70E-DP\MR (Hardware-Rev. 1)

Material:
Edelstahl gebürstet 0,8 mm
Toleranzen:
Bohrdurchmesser: +/- 0,05 mm
Längenmaß: +/- 0,01 mm

Material:
Brushed stainless steel 0.8 mm
Tolerances:
Drilling diameter: +/- 0.05 mm
Length: +/- 0.01 mm

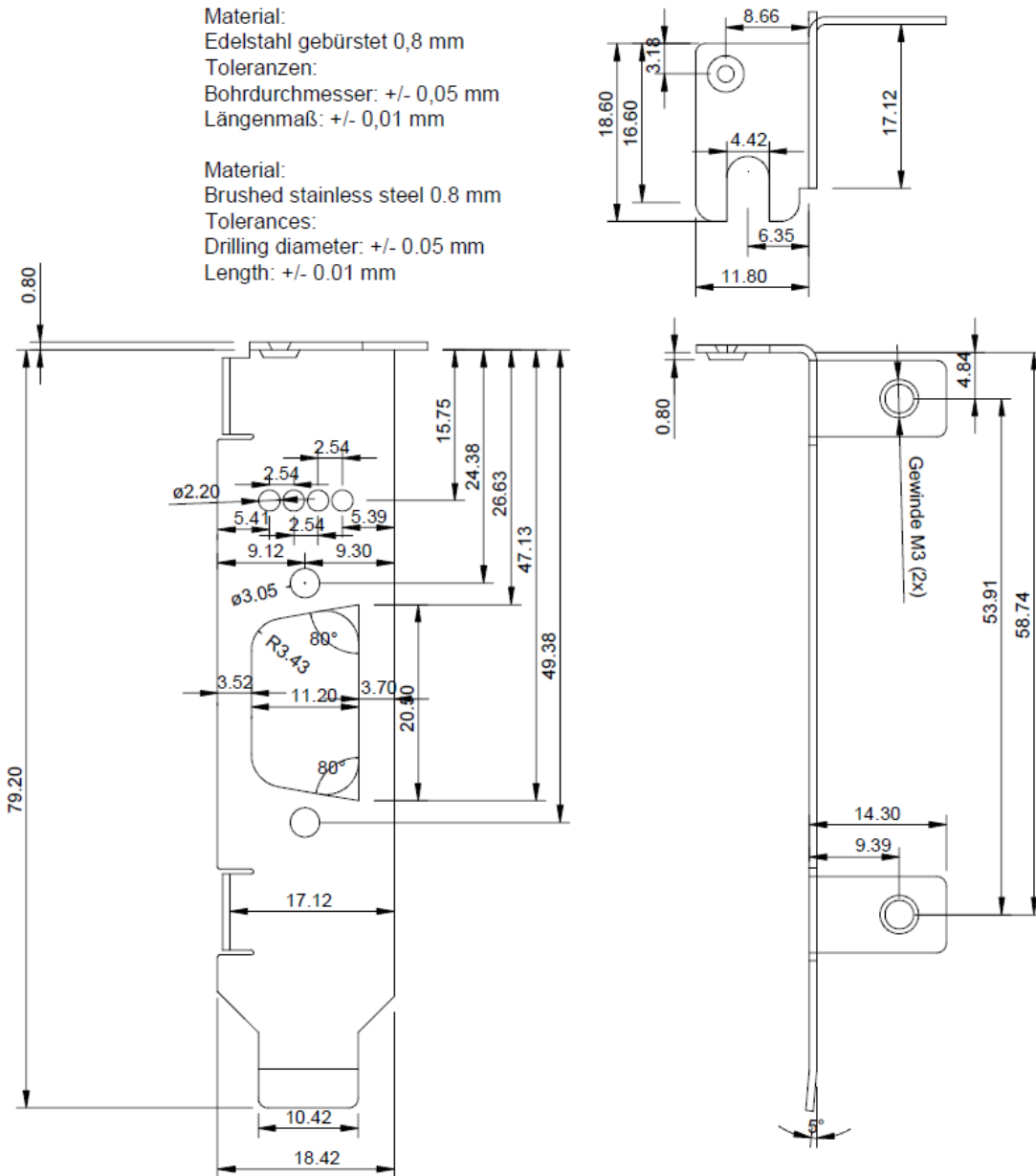

Figure 84: Blende für CIFX 70E-DP, CIFX 70E-DPWR

11.4.4 CIFX 70E-CO, CIFX 70E-CO\MR

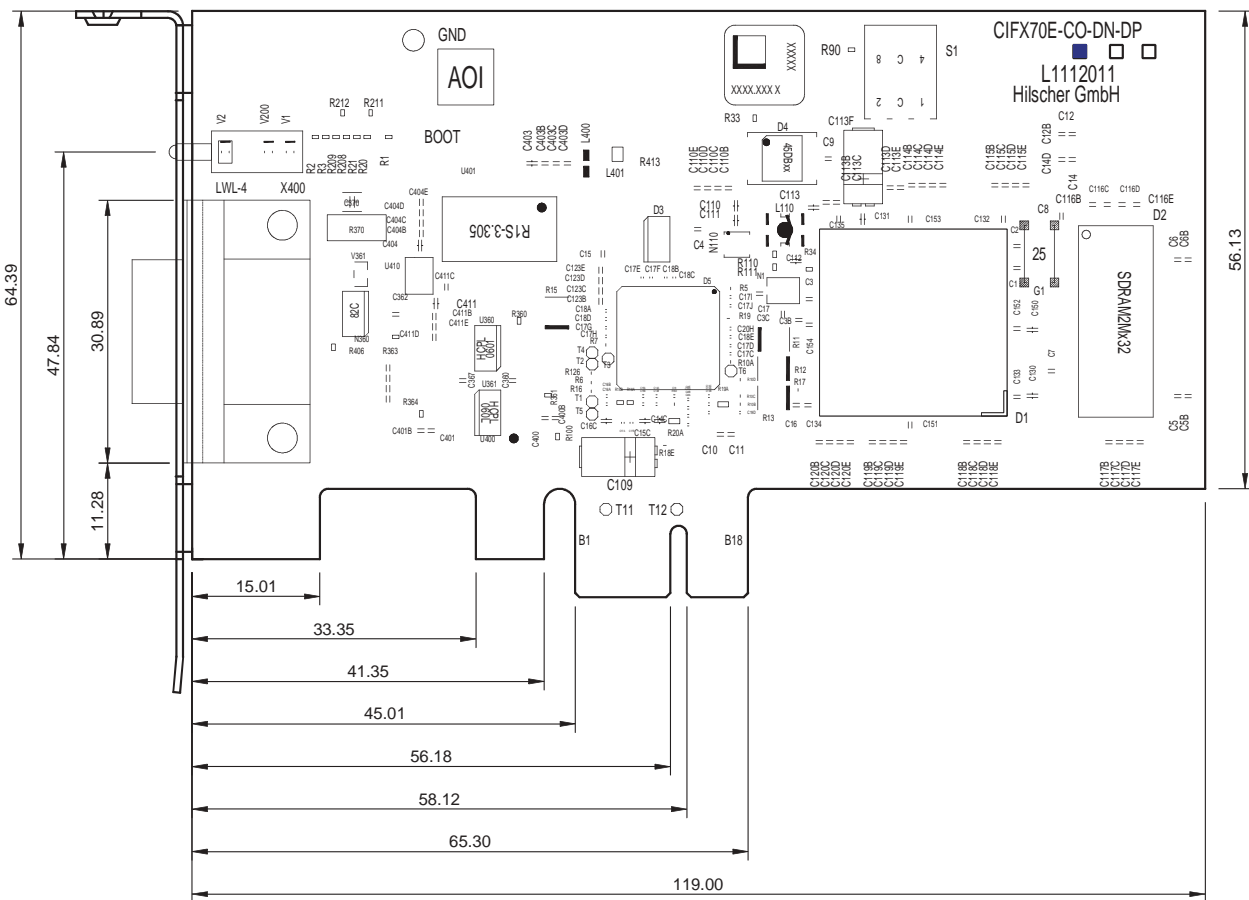

Figure 85: Dimensions CIFX 70E-CO and CIFX 70E-CO\MR (Hardware-Rev. 1)

11.4.5 Front Panel CIFX 70E-CO, CIFX 70E-CO\MR

Material:
Edelstahl gebürstet 0,8 mm
Toleranzen:
Bohrdurchmesser: +/- 0,05 mm
Längenmaß: +/- 0,01 mm

Material:
Brushed stainless steel 0.8 mm
Tolerances:
Drilling diameter: +/- 0.05 mm
Length: +/- 0.01 mm

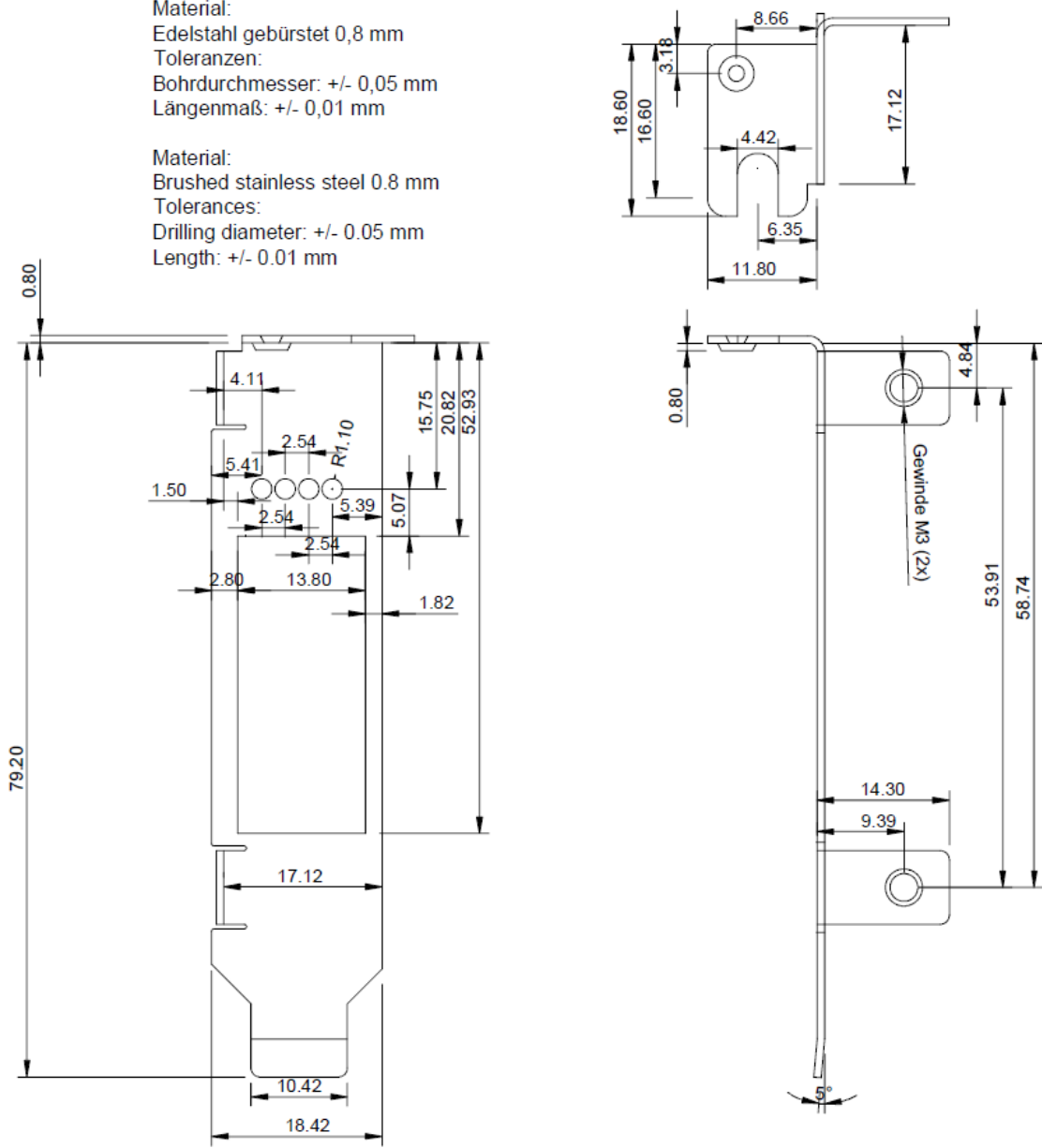

Figure 86: Dimensions Front Panel für CIFX 70E-CO, CIFX 70E-CO\MR

11.4.6 CIFX 70E-DN, CIFX 70E-DN\MR

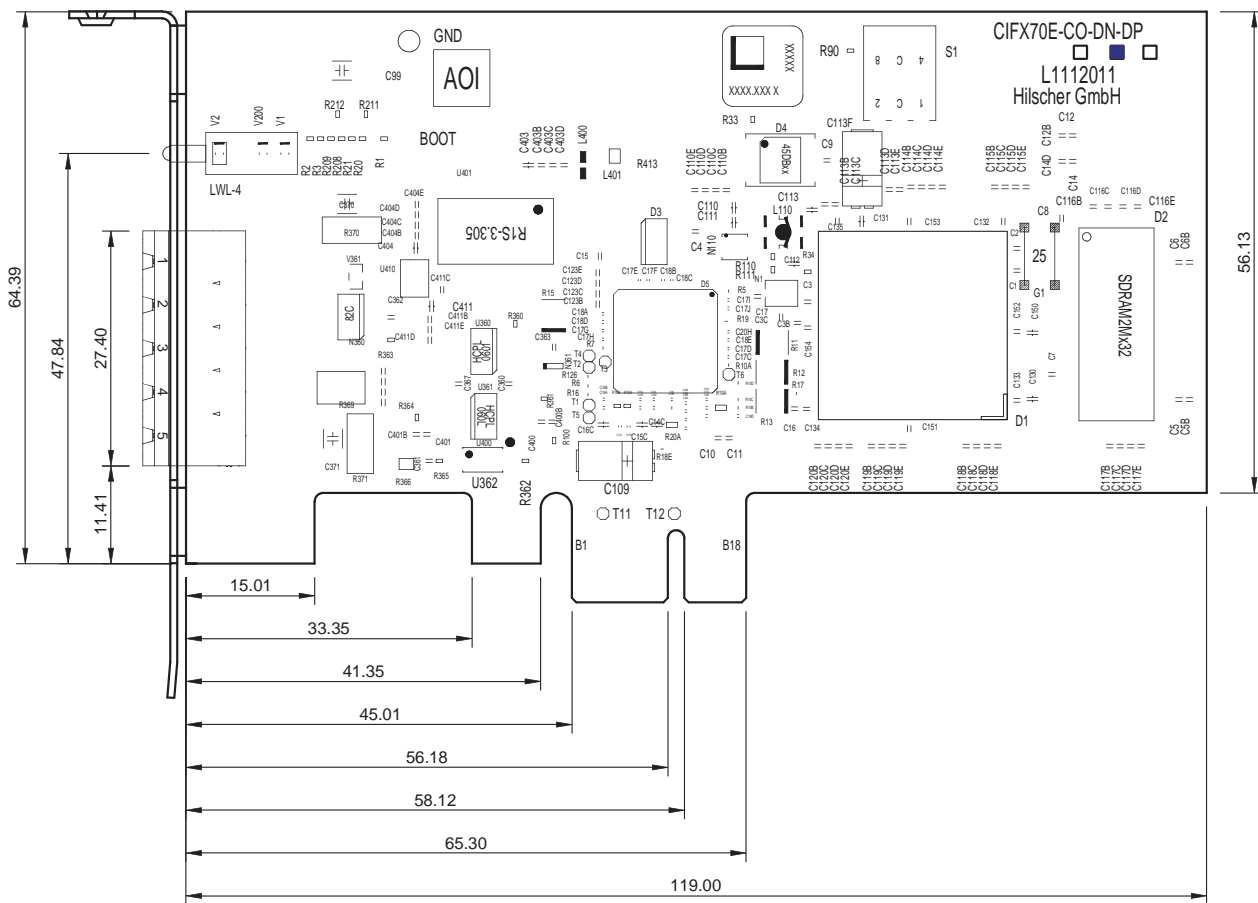

Figure 87: Dimensions CIFX 70E-DN and CIFX 70E-DN\MR (Hardware-Rev. 1)

11.4.7 Front Panel CIFX 70E-DN, CIFX 70E-DNMR

Material:
Edelstahl gebürstet 0,8 mm
Toleranzen:
Bohrdurchmesser: +/- 0,05 mm
Längenmaß: +/- 0,01 mm

Material:
Brushed stainless steel 0.8 mm
Tolerances:
Drilling diameter: +/- 0.05 mm
Length: +/- 0.01 mm

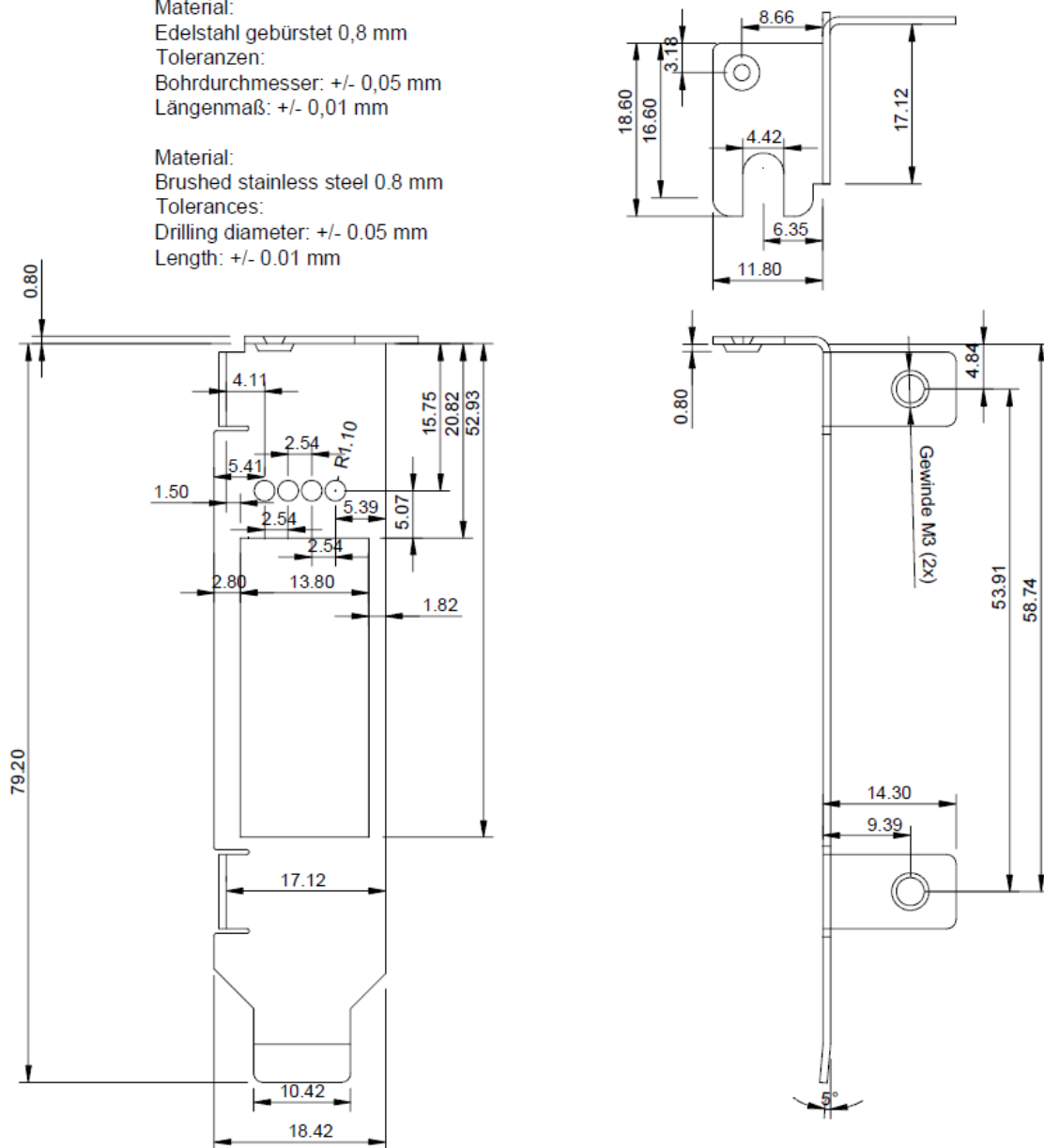

Figure 88: Dimensions Front Panel CIFX 70E-DN, CIFX 70E-DNMR

11.5 Notes on earlier Hardware Revisions

11.5.1 Failure in 10 MBit/s Half Duplex Mode and Workaround

The note is only valid for the PC cards cifX up to serial numbers indicated:

PC Cars cifX	Part No	up to Serial Number
CIFX 50-RE	1250.100	22414
CIFX 50E-RE	1251.100	20167

NOTICE

Failure of the Network Communication

- Do not operate hardware with the communication controllers netX 50, netX100 or netX 500 with the protocols Ethernet TCP/UDP/IP, EtherNet/IP or Modbus TCP at 10 MBit/s in half-duplex mode, otherwise failure of the network communication can occur.
- Use only switches or 10/100 MBit/s dual-speed hubs and ensure that the network operates at 100 MBit/s and in full-duplex mode.

Affected Hardware

Hardware with the communication controller netX 50, netX 100 or netX 500; netX/Internal PHYs.

When can this Failure occur?

When using standard Ethernet communication with 10 MBit/s half duplex mode, the PHY gets stuck in case of network collisions. Then no further network communication is possible. Only device power cycling allows Ethernet communication again.

This problem can only occur with Ethernet TCP/UDP IP, EtherNet/IP or Modbus TCP protocols when using hubs at 10 MBit/s. The issue described above is not applicable for protocols which use 100 MBit/s or full duplex mode.

Solution / Workaround:

Do not use 10 MBit/s-only hubs. Use either switches or 10/100 MBit/s Dual Speed hubs, to make sure the netX Ethernet ports are connected with 100 MBit/s or in full duplex mode.

This erratum is fixed with all components of the 'Y' charge (9 digit charge number shows 'Y' at position 5 (nnnnYnnnn)).

Reference

"Summary of 10BT problem on EthernetPHY",
RenesasElectronics Europe, April 27, 2010

11.6 Disposal of Waste Electronic Equipment

According to the European Directive 2002/96/EG “Waste Electrical and Electronic Equipment (WEEE)”, waste electronic equipment may not be disposed of as household waste. As a consumer, you are legally obliged to dispose of all waste electronic equipment according to national and local regulations.



Waste Electronic Equipment

- This product must not be treated as household waste.
- This product must be disposed of at a designated waste electronic equipment collecting point.

11.7 References

- [1] THE CIP NETWORKS LIBRARY, Volume 6, CompoNet Adaptation of CIP, Edition 1.4 November 2008
- [2] Data sheet MOD JACK – MJIM:
<https://www.erni-x-press.com/de/downloads/zeichnungen/203313.pdf>
- [3] Design - Specification for VARAN Rev. 0.76, section 5.1.4 VARAN Splitter

References Protocol API Manuals
• AS-Interface Master Protocol API Manual, Revision 4, Hilscher GmbH 2012
• CANopen Master Protocol API Manual, Revision 14, Hilscher GmbH 2013
• CANopen Slave Protocol API Manual (V3), Revision 5, Hilscher GmbH 2013
• CC-Link Slave Protocol API Manual, Revision 8, Hilscher GmbH 2013
• DeviceNet Master Protocol API Manual, Revision 10, Hilscher GmbH 2013
• DeviceNet Slave Protocol API Manual, Revision 13, Hilscher GmbH 2013
• EtherCAT Master Protocol API Manual (V3), Revision 5, Hilscher GmbH 2013
• EtherCAT Slave Protocol API Manual, Revision 3 (V4), Hilscher GmbH 2013
• EtherCAT Slave Protocol API Manual, Revision 21 (V2), Hilscher GmbH 2013
• EtherNet/IP Scanner Protocol API Manual, Revision 13, Hilscher GmbH 2013
• EtherNet/IP Adapter Protocol API Manual, Revision 12, Hilscher GmbH 2013
• Open Modbus/TCP Protocol API Manual, Revision 8, Hilscher GmbH 2013
• POWERLINK Controlled Node/Slave Protocol API Manual, Revision 12, Hilscher GmbH 2013
• PROFIBUS DP Master Protocol API Manual, Revision 18, Hilscher GmbH 2013
• PROFIBUS DP Slave Protocol API Manual, Revision 15, Hilscher GmbH 2013
• PROFIBUS MPI Protocol API Manual, Revision 4, Hilscher GmbH 2011
• PROFINET IO-Controller Protocol API Manual, Revision 18, Hilscher GmbH 2013
• PROFINET IO-Device Protocol API Manual (V3.4), Revision 13, Hilscher GmbH 2013
• PROFINET IO-Device Protocol API Manual (V3.5), Revision 6, Hilscher GmbH 2013
• sercos Master Protocol API Manual, Revision 11, Hilscher GmbH 2013
• sercos Slave Protocol API Manual (V3), Revision 12, Hilscher GmbH 2013
• VARAN Client Protocol API Manual, Revision 3, Hilscher GmbH 2013

Table 141: References Protocol API Manuals

References referring to the safety issues are listed separately in section *References Safety* on page 26. References referring to the Standard Bus Specifications for PCI and PCI Express are listed separately *References PCI Specifications* on page 114.

11.8 EtherCAT Summary over Vendor ID, Conformance test, Membership and Network Logo

11.8.1 Vendor ID

The communication interface product is shipped with Hilscher's secondary vendor ID, which has to be replaced by the Vendor ID of the company shipping end products with the integrated communication interface. End Users or Integrators may use the communication interface product without further modification if they re-distribute the interface product (e.g. PCI Interface card products) only as part of a machine or machine line or as spare part for such a machine. In case of questions, contact Hilscher and/or your nearest ETG representative. The ETG Vendor-ID policies apply.

11.8.2 Conformance

EtherCAT Devices have to conform to the EtherCAT specifications. The EtherCAT Conformance Test Policies apply, which can be obtained from the EtherCAT Technology Group (ETG, www.ethercat.org).

Hilscher range of embedded network interface products are conformance tested for network compliance. This simplifies conformance testing of the end product and can be used as a reference for the end product as a statement of network conformance (when used with standard operational settings). It must however be clearly stated in the product documentation that this applies to the network interface and not to the complete product.

Conformance Certificates can be obtained by passing the conformance test in an official EtherCAT Conformance Test lab. Conformance Certificates are not mandatory, but may be required by the end user.

11.8.3 Certified Product vs. Certified Network Interface

The EtherCAT implementation may in certain cases allow one to modify the behavior of the EtherCAT network interface device in ways which are not in line with EtherCAT conformance requirements. For example, certain communication parameters are set by a software stack, in which case the actual software implementation in the device application determines whether or not the network interface can pass the EtherCAT conformance test. In such cases, conformance test of the end product must be passed to ensure that the implementation does not affect network compliance.

Generally, implementations of this kind require in-depth knowledge in the operating fundamentals of EtherCAT. To find out whether or not a certain type of implementation can pass conformance testing and requires such testing, contact EtherCAT Technology Group ("ETG", www.ethercat.org) and/or your nearest EtherCAT conformance test centre. EtherCAT may allow the combination of an untested end product with a conformant network interface. Although this may in some cases make it possible to sell the end product without having to perform network conformance tests, this approach is generally not endorsed by Hilscher. In case of questions, contact Hilscher and/or your nearest ETG representative.

11.8.4 Membership and Network Logo

Generally, membership in the network organization and a valid Vendor-ID are prerequisites in order to be able to test the end product for conformance. This also applies to the use of the EtherCAT name and logo, which is covered by the ETG marking rules.

Vendor ID Policy accepted by ETG Board of Directors, November 5, 2008

11.9 List of Figures

Figure 1: System Overview cifX to update Firmware, Driver and Software	44
Figure 2: CIFX 50-RE* (from hardware rev. 3), CIFX 50-RE\ET* (from hardware rev. 1)	45
Figure 3: CIFX 50E-RE* (from hardware rev. 4), CIFX 50E-RE\ET* (from hardware rev. 1)	45
Figure 4: Front Plate for CIFX 50-RE, CIFX 50-RE\ET, CIFX 50E-RE or CIFX 50E-RE\ET	46
Figure 5: CIFX 50-DP (hardware revision 5)*	47
Figure 6: CIFX 50E-DP (hardware revision 5)*	47
Figure 7: Front Plate CIFX 50-DP or CIFX 50E-DP	48
Figure 8: CIFX 50-2DP (Hardware Revision 3)	49
Figure 9: Front Plate CIFX 50-2DP	49
Figure 10: CIFX 50-2DP\CO (Hardware Revision 2)	50
Figure 11: Front Plate CIFX 50-2DP\CO	50
Figure 12: CIFX 50-2DP\DN (Hardware Revision 1)	51
Figure 13: Front Plate CIFX 50-2DP\DN	51
Figure 14: CIFX 50-CO (hardware revision 5)	52
Figure 15: CIFX 50E-CO (from hardware revision 4)	52
Figure 16: Front Plate for CIFX 50-CO or CIFX 50E-CO	53
Figure 17: CIFX 50-2CO (Hardware Revision 2)	54
Figure 18: Front Plate CIFX 50-2CO	54
Figure 19: CIFX 50-2 CO\DN (Hardware Revision 1)	55
Figure 20: Front Plate CIFX 50-2CO\DN	55
Figure 21: CIFX 50-DN (hardware revision 5)	56
Figure 22: CIFX 50E-DN (from hardware revision 4)	56
Figure 23: Front Plate CIFX 50-DN or CIFX 50E-DN	57
Figure 24: CIFX 50-2DN (Hardware Revision 2)	58
Figure 25: Front Plate CIFX 50-2DN	58
Figure 26: CIFX 50-2ASM (hardware revision 2)	59
Figure 27: CIFX 50E-2ASM (from hardware revision 2)	59
Figure 28: Front Plate CIFX 50-2ASM	60
Figure 29: CIFX 50-CC (hardware revision 2)*	61
Figure 30: CIFX 50E-CC (hardware revision 4)*	61
Figure 31: Front Plate CIFX 50-CC or CIFX 50E-CC	62
Figure 32: CIFX 70E-RE* (Hardware revision 1)	63
Figure 33: CIFX 70E-RE\MR* (Hardware revision 1)	63
Figure 34: Front Plate for CIFX 70E-RE, CIFX 70E-RE\MR	64
Figure 35: CIFX 100EH-RE\CUBE*	65
Figure 36: Front Plate CIFX 100EH-RE\CUBE	65
Figure 37: CIFX 70E-DP (Hardware revision 1)	66
Figure 38: CIFX 70E-DP\MR (Hardware revision 1)	66
Figure 39: Front Plate CIFX 70E-DP, CIFX 70E-DP\MR	67
Figure 40: CIFX 70E-CO (Hardware revision 1)	68
Figure 41: CIFX 70E-CO\MR (Hardware revision 1)	68
Figure 42: Front Plate CIFX 70E-CO, CIFX 70E-CO\MR	69
Figure 43: CIFX 70E-DN (Hardware revision 1)	70
Figure 44: CIFX 70E-DN\MR (Hardware revision 1)	70
Figure 45: Front Plate CIFX 70E-DN, CIFX 70E-DN\MR	71
Figure 46: Front Plate Stickers for CIFX 50-RE, CIFX 50-RE\ET, CIFX 50E-RE or CIFX 50E-RE\ET	74
Figure 47: Front Plate Stickers for CIFX 70E-RE, CIFX 70E-RE\MR	76
Figure 48: Front Plate Stickers for CIFX 100EH-RE\CUBE	76
Figure 49: Ethernet Pin Assignment at the RJ45 Socket for cifX or AIFX	105
Figure 50: PROFIBUS Interface (DSub female connector, 9 pin), X400	107
Figure 51: CANopen Interface (DSub male connector, 9 pin), X400	107

Figure 52: DeviceNet Interface (CombiCon male Connector, 5 pin), X360	108
Figure 53: AS-Interface Interface (CombiCon male Connector, 2 pin)	108
Figure 54: CC-Link Interface (CombiCon male Connector, 5 pin)	109
Figure 55: Example 2D Label (mini sticker on the right)	173
Figure 56: Dimensions CIFX 50-RE (from Hardware-Rev. 3), CIFX 50-RE\ET (from Hardware-Rev. 1)	174
Figure 57: Dimensions CIFX 50E-RE (from Hardware-Rev. 4), CIFX 50E-RE\ET (from Hardware-Rev. 1)	175
Figure 58: Dimensions Front Panel CIFX 50-RE, CIFX 50-RE\ET, CIFX 50E-RE or CIFX 50E-RE\ET	176
Figure 59: Dimensions CIFX 50-DP (Hardware-Rev. 5)	177
Figure 60: Dimensions CIFX 50E-DP (Hardware-Rev. 6)	178
Figure 61: Dimensions Front Panel CIFX 50-DP or CIFX 50E-DP	179
Figure 62: Dimensions CIFX 50-CO (Hardware-Rev. 5)	180
Figure 63: Dimensions CIFX 50E-CO (from Hardware-Rev. 4)	181
Figure 64: Dimensions Front Panel für CIFX 50-CO or CIFX 50E-CO	182
Figure 65: Dimensions CIFX 50-DN (Hardware-Rev. 5)	183
Figure 66: Dimensions CIFX 50E-DN (from Hardware-Rev. 4)	184
Figure 67: Dimensions Front Panel CIFX 50-DN or CIFX 50E-DN	185
Figure 68: Dimensions CIFX 50-CC (Hardware-Rev. 2)	186
Figure 69: Dimensions CIFX 50E-CC (from Hardware-Rev. 4)	187
Figure 70: Dimensions Front Panel CIFX 50-CC or CIFX 50E-CC	188
Figure 71: Dimensions CIFX 50-2DP (Hardware-Rev. 3)	189
Figure 72: Dimensions CIFX 50-2DP\CO (Hardware-Rev. 2)	190
Figure 73: Dimensions CIFX 50-2DP\DN (Hardware-Rev. 1)	191
Figure 74: Dimensions CIFX 50-2CO (Hardware-Rev. 2)	192
Figure 75: Dimensions CIFX 50-2CO\DN (Hardware-Rev. 1)	193
Figure 76: Dimensions CIFX 50-2DN (Hardware-Rev. 2)	194
Figure 77: Dimensions Front Panel CIFX 50-2FB	195
Figure 78: Dimensions CIFX 50-2ASM (Hardware-Rev. 2)	196
Figure 79: Dimensions CIFX 50E-2ASM (from Hardware-Rev. 2)	197
Figure 80: Dimensions Front Panel CIFX 50-2ASM, CIFX 50E-2ASM	198
Figure 81: Dimensions CIFX 70E-RE and CIFX 70E-RE\MR (Hardware-Rev. 1)	199
Figure 82: Dimensions Front Panel für CIFX 70E-RE, CIFX 70E-RE\MR	200
Figure 83: Dimensions CIFX 70E-DP and CIFX 70E-DP\MR (Hardware-Rev. 1)	201
Figure 84: Blende für CIFX 70E-DP, CIFX 70E-DP\MR	202
Figure 85: Dimensions CIFX 70E-CO and CIFX 70E-CO\MR (Hardware-Rev. 1)	203
Figure 86: Dimensions Front Panel für CIFX 70E-CO, CIFX 70E-CO\MR	204
Figure 87: Dimensions CIFX 70E-DN and CIFX 70E-DN\MR (Hardware-Rev. 1)	205
Figure 88: Dimensions Front Panel CIFX 70E-DN, CIFX 70E-DN\MR	206

11.10 List of Tables

Table 1: List of Revisions	9
Table 2: Reference on Hardware PC Cards cifX	10
Table 3: Reference on Driver and Software	11
Table 4: Reference on Firmware (for 1 Channel Systems)	11
Table 5: Reference on Firmware (for 2 Channel Systems)	12
Table 6: PROFINET IO-Device Firmware Version 3.4 and 3.5, Header, GSDML and Protocol API Manual	15
Table 7: EtherCAT-Slave Firmware Version 2.5 and 4.2, Header, XML and Protocol API Manual	16
Table 8: Device Description Files for PC Cards cifX	17
Table 9: PC Cards cifX and the Real-Time Ethernet or Fieldbus Systems realized thereby	22
Table 10: Signal Words and Safety Signs in Safety Messages on Personal Injury	26
Table 11: Signal Words and Safety Signs in Safety Messages on Property Damage	26

Table 12: PC Cards PCI CIFX 50-XX	27
Table 13: PC Cards PCI (2 Channels) CIFX 50-2XX, CIFX 50-2XX\XX	28
Table 14: PC Cards PCI Express CIFX 50E-XX, CIFX 70E-XX	28
Table 15: Firmware Versions for the Function Slot Number (Card I), (for 1 Channel Systems)	29
Table 16: Firmware Versions for the Function Slot Number (Card ID) (for 2 Channel Systems)	30
Table 17: Versions Driver, Bootloader and SYCON.net for Function Slot Number (Card ID)	30
Table 18: Firmware Versions for the DMA Mode (for 1 Channel Systems)	31
Table 19: Firmware Versions for the DMA Mode (for 2 Channel Systems)	32
Table 20: Versions Driver and SYCON.net for the DMA Mode	32
Table 21: Slot for the PC Cards cifX PCI, PCIe and Low Profile PCIe	33
Table 22: Requirements Power Supply and Host Interface for PC Cards cifX PCI, PCIe Low Profile PCIe	34
Table 23: Requirements to operate PC Cards cifX properly	35
Table 24: Steps for the Software and Hardware Installation, the Configuration and for the Diagnosis of a PC Card cifX (Master and Slave)	40
Table 25: Notes for the Configuration of the Master Device	41
Table 26: Device Names in SYCON.net by Communication Protocol	43
Table 27: Assignment of the LEDs to the Channels	62
Table 28: LED Labeling depending of the loaded Firmware	74
Table 29: Fix Front Plate Sticker at the CIFX 70E-RE, CIFX 70E-RE\MR or CIFX 100EH-RE\CUBE	75
Table 30: LED Labeling depending of the loaded Firmware	76
Table 31: Overview LEDs Real-Time Ethernet Systems	80
Table 32: LED Names	80
Table 33: Overview LEDs by Fieldbus System for 1 Channel Devices	81
Table 34: Overview LEDs by Fieldbus System for 2 Channel Devices	81
Table 35: LED Names	81
Table 36: System Status LED States	82
Table 37: System Status LED State Definitions	82
Table 38: LED states for the EtherCAT Master protocol	83
Table 39: LED state definitions for the EtherCAT Master protocol	83
Table 40: LED states for the EtherCAT Slave protocol	84
Table 41: LED state definitions for the EtherCAT Slave protocol	84
Table 42: LED states for the EtherNet/IP Scanner protocol	85
Table 43: LED state definitions for the EtherNet/IP Scanner protocol	85
Table 44: LED states for the EtherNet/IP Adapter protocol	86
Table 45: LED state definitions for the EtherNet/IP Adapter protocol	86
Table 46: LED states for the OpenModbusTCP protocol	87
Table 47: LED state definitions for the OpenModbusTCP protocol	87
Table 48: LED states for the POWERLINK Controlled Node protocol	88
Table 49: LED state definitions for the POWERLINK Controlled Node protocol	88
Table 50: LED states for the PROFINET IO-Controller protocol	89
Table 51: LED state definitions for the PROFINET IO-Controller protocol	89
Table 52: LED states for the PROFINET IO-Device protocol	90
Table 53: LED state definitions for the PROFINET IO-Device protocol	90
Table 54: LED states for the sercos Master protocol	91
Table 55: LED state definitions for the sercos Master protocol	92
Table 56: LED state definitions for the sercos Slave protocol	93
Table 57: LED state definitions for the sercos Slave protocol	94
Table 58: LED-Zustände für das VARAN-Client-Protokoll	95
Table 59: Definitionen der LED-Zustände für das VARAN-Client-Protokoll	95
Table 60: LED states for the PROFIBUS DP Master protocol	96
Table 61: LED state definitions for the PROFIBUS DP Master protocol	96
Table 62: LED states for the PROFIBUS DP Slave protocol	97
Table 63: LED state definitions for the PROFIBUS DP Slave protocol	97

Table 64: LED states for the PROFIBUS MPI protocol	98
Table 65: LED state definitions for the PROFIBUS MPI protocol	98
Table 66: LED states for the CANopen Master protocol	99
Table 67: LED state definitions for the CANopen Master protocol	99
Table 68: States of the CAN LED for the CANopen Slave protocol – 1 Communication Status LED (current Hardware Revision)	100
Table 69: LED state definitions for the CANopen Slave protocol	100
Table 70: LED states for the DeviceNet Master protocol	101
Table 71: LED state definitions for the DeviceNet Master protocol	101
Table 72: LED states for the DeviceNet Slave protocol	102
Table 73: LED state definitions for the DeviceNet Slave protocol	102
Table 74: LEDs states for the AS-Interface Master protocol	103
Table 75: LED state definitions for the AS-Interface Master protocol	103
Table 76: LED states for the CC-Link Slave protocol	104
Table 77: LED state definitions for the CC-Link Slave protocol	104
Table 78: Ethernet Pin Assignment at the RJ45 Socket for cifX or AIFX	105
Table 79: Ethernet Connection Data	106
Table 80: Use of Hubs and Switches	106
Table 81: PROFIBUS Interface, X400	107
Table 82: CANopen Interface, X400	107
Table 83: DeviceNet Interface, X360	108
Table 84: AS-Interface Interface	108
Table 85: CC-Link Interface	109
Table 86: Rotary Switch for Slot Number (Card ID), S1	110
Table 87: Rotary Switch Slot Number (Card ID) PC Cards cifX Low Profile PCI Express	111
Table 88: Pin Assignment for SYNC Connector, X51	112
Table 89: Pin Assignment for SYNC Connector, J1	112
Table 90: SYNC Connector: SYNC Signal, Connector, Max. Cable Length	113
Table 91: Meaning of the SYNC Signals for each Protocol	113
Table 92: Pin Assignment at the PCI Bus	114
Table 93: References PCI Specifications	114
Table 94: Pin Assignment for PCI Express-Bus CIFX 100EH-RE\CUBE	115
Table 95: Technical Data CIFX 50-RE, CIFX 50-RE\ET	117
Table 96: Technical Data CIFX 50E-RE, CIFX 50E-RE\ET	119
Table 97: Technical Data CIFX 50-DP	121
Table 98: Technical Data CIFX 50E-DP	122
Table 99: Technical Data CIFX 50-CO	124
Table 100: Technical Data CIFX 50E-CO	125
Table 101: Technical Data CIFX 50-DN	127
Table 102: Technical Data CIFX 50E-DN	128
Table 103: Technical Data CIFX 50-CC	129
Table 104: Technical Data CIFX 50E-CC	131
Table 105: Technical Data CIFX 50-2DP	132
Table 106: Technical Data CIFX 50-2DP\CO	134
Table 107: Technical Data CIFX 50-2DP\DN	136
Table 108: Technical Data CIFX 50-2CO	137
Table 109: Technical Data CIFX 50-2CO\DN	138
Table 110: Technical Data CIFX 50-2DN	140
Table 111: Technical Data CIFX 50-2ASM	141
Table 112: Technical Data CIFX 50E-2ASM	143
Table 113: Technical Data CIFX 70E-RE, CIFX 70E-RE\MR	144
Table 114: Technical Data CIFX 100EH-RE\CUBE	147
Table 115: Technical Data CIFX 70E-DP, CIFX 70E-DP\MR	148

Table 116: Technical Data CIFS 70E-CO, CIFS 70E-CO\MR	149
Table 117: Technical Data CIFS 70E-DN, CIFS 70E-DN\MR	151
Table 118: PCI IDs PC Cards cifX on the PCI Bus	152
Table 119: Supported / not supported PCI Bus Commands	152
Table 120: Technical Data EtherCAT Master Protocol	153
Table 121: Technical Data EtherCAT Slave Protocol	154
Table 122: Technical Data EtherNet/IP Scanner (Master) Protocol	155
Table 123: Technical Data EtherNet/IP Adapter (Slave) Protocol	156
Table 124: Technical Data Open Modbus/TCP Protocol	157
Table 125: Technical Data POWERLINK Controlled Node (Slave) Protocol	157
Table 126: Technical Data PROFINET IO RT Controller	159
Table 127: Technical Data PROFINET IO RT IRT Device Protocol	159
Table 128: Technical Data PROFINET IO RT IRT Device Protocol	160
Table 129: Technical Data sercos Master Protocol	161
Table 130: Technical Data sercos Slave Protocol	162
Table 131: Technical Data VARAN Client Protocol	163
Table 132: Technical Data PROFIBUS DP Master Protocol	164
Table 133: Technical Data PROFIBUS DP Slave Protocol	165
Table 134: Technical Data PROFIBUS-MPI Protocol	166
Table 135: Technical Data CANopen Master Protocol	167
Table 136: Technical Data CANopen Slave Protocol	168
Table 137: Technical Data DeviceNet Master Protocol	169
Table 138: Technical Data DeviceNet Slave Protocol	170
Table 139: Technical Data AS-Interface Master Protocol	171
Table 140: Technical Data CC-Link-Slave Protocol	172
Table 141: References Protocol API Manuals	208

11.11 Glossary

10-Base T

Standard for communication on Ethernet over twisted pair lines with RJ45 connectors and a [Baud rate](#) of 10 MBit/s (according to the IEEE 802.3 specification).

100-Base TX

Standard for communication on Ethernet over unshielded twisted pair lines with RJ45 connectors and a baud rate of 100 MBit/s according to the IEEE 802. specification

Auto-Crossover

Auto-Crossover is a feature of an interface: An interface with Auto-Crossover capability will automatically detect and correct if the data lines have been exchanged vice versa.

Auto-Negotiation

Auto-Negotiation is a feature of an interface: An interface with Auto-Negotiation will automatically determine a set of correct communication parameters.

Baud rate

Data transmission speed of a communication channel or interface.

Boot loader

Program loading the firmware into the memory of a device in order to be executed.

Ch0, Ch1 ...

Within the configuration software SYCON.net the communication channels are named ,Ch0', Ch1'

For the Real-Time-Ethernet devices cifX, comX and netJACK and the Real-Time Ethernet protocols used with it, the following shall apply:

'Ch0' in SYCON.net: Both ports of the Ethernet RJ45 connector CH0 and CH1 are assigned always to channel 0 in SYCON.net.

'Ch1' in SYCON.net: Depending on the firmware channel 1 in SYCON.net can be used as an additional communication channel.

CH0, CH1 (Ch0, Ch1)

Names for the ports of an Ethernet RJ45 socket with two Ethernet channels.

CH0 stands for Ethernet channel 0.

CH1 stands for Ethernet channel 1.

cifX

Communication InterFace based on netX

cifX TCP/IP Server

cifX TCP Server.exe

Program for the remote diagnostics via Ethernet.

Name: **cifX TCP/IP Server for SYCON.net**

User Interface: **TCP/IP Server for cifX**

Coil

A coil is a single bit in the memory that can be accessed using Modbus: read or write access with FC 1, 5, 15. Depending on the used Modbus function code a single coil or several coils lying in succession can be accessed.

CSP

electronic device data sheet, required for each CC-Link device

Device Description File

A file containing configuration information about a device being a part of a network that can be read out by masters for system configuration. Device Description Files use various formats which depend on the communication system.

DHCP

Dynamic Host Configuration Protocol

This is a protocol simplifying the configuration of IP networks by automatically assigning IP addresses.

Discrete Input

A "Discrete Input" (as defined in the Modbus terminology) is a single bit in the memory which can be accessed using Modbus (read with FC 2).

DP

Decentral Periphery

DPM

Dual-Port Memory

EDS

Electronic Data Sheet

EDS file

A special kind of Device Description File used for example by EtherNet/IP.

ET

Extended Temperature Range (Operating Temperature)

PC cards cifX with the addition of "ET" at the end of the part name can be used in an extended operating temperature range. Details to the operating temperature range are given in the technical data to the respective card.

EtherCAT

A communication system for industrial Ethernet designed and developed by Beckhoff Automation GmbH.

Ethernet

A networking technology used both for office and industrial communication via electrical or optical connections. It has been developed and specified by the Intel, DEC and XEROX. It provides data transmission with collision control and allows various protocols. As Ethernet is not necessarily capable for real-time application, various real-time extensions have been developed.

EtherNet/IP

A communication system for industrial Ethernet designed and developed by Rockwell. It partly uses the CIP (Common Industrial Protocol).

EtherNet/IP Scanner

A Scanner exchanges real-time I/O data with Adapters and Scanners. This type of node can respond to connection requests and can also initiate connections on its own.

EtherNet/IP Adapter

An Adapter emulates functions provided by traditional rack-adapter products. This type of node exchanges real-time I/O data with a Scanner Class product. It does not initiate connections on its own.

Ethernet POWERLINK

A communication system for industrial Ethernet designed and developed by B&R. It partly uses CANopen technologies.

FDL

Fieldbus Data Link defines the PROFIBUS communication on layer 2, identical for DP and FMS

Firmware

Software running inside a device providing the basic functionality of this device. It can be updated by a firmware download.

Full duplex

Full duplex denominates a telecommunication system between two communication partners which allows simultaneous communication in both directions is called a full-duplex telecommunication system. At such a system, it will be possible to transmit data even if currently data are received. Full-duplex is the opposite of Half_duplex.

Function code

A function code (FC) is a standardized method to access, i. e. read or write on coils (Bits) or registers via Modbus.

Modbus function codes are elements of Modbus request/reply telegrams.

GSD

Generic Station Description, Device description file

GSD file

A special kind of Device Description File used by PROFIBUS (GSD = Generic Station Description).

GSDML

Generic Station Description Markup Language

XML based device description file.

GSDML file

A special kind of XML-based Device Description File used by PROFINET.

Half duplex

Half duplex denominates a telecommunication system between two communication partners which does not allow simultaneous, but alternating, communication in both directions is called a half-duplex telecommunication system. At such a system, receiving data inhibits the transmission of data. Half-duplex is the opposite of _Full_duplex.

Hub

A network component connecting multiple communication partners with each other. A hub does not provide own intelligence, thus it does not analyze the data traffic and sends received data to all connected communication partners. A hub can be used for setting up a star topology.

Industrial Ethernet

See Real-Time Ethernet

IP

Internet Protocol.

IP belongs to the TCP/IP family of protocols and is defined in RFC791. It is based on layer 3 of the ISO/OSI 7 layer model of networking.

It is a connectionless protocol, i.e. you do not need to open a connection to a computer before sending an IP data packet to it. Therefore IP is not able to guarantee that the IP data packets really arrive at the recipient. On IP level neither the correctness of data nor the consistence and completeness are checked.

IP defines special addressing mechanisms, see IP Address.

IP Address

Address within IP (the Internet Protocol, part of TCP/IP).

An IP address is an address identifying a device or a computer within a network using the IP protocol. IP addresses are defined as a 32 bit number. Usually, for ease of notation the IP address is divided into four 8 bit numbers which are represented in decimal notation and separated by points:

a.b.c.d

where a.b.c.d are each integer values between 0 and 255.

Example: 192.168.30.15

However, not all combinations are allowed, some are reserved for special purposes.

The IP address 0.0.0.0 is defined as invalid.

MAC-ID

MAC = Media Access Control

Definition for Ethernet:

A MAC-ID is on delivery a unique (physical) Ethernet address of the device.

MAC-IDs are defined as a 48 bit number. Usually, for ease of notation the MAC-ID address is divided into six 8 bit numbers which are represented in hexadecimal notation and separated by "minus"-signs (-):

A-B-C-D-E-F

where A-B-C-D-E-F are each integer values between 0 and 255.

Example: 00-02-A2-20-91-18

Definition for DeviceNet: The MAC-ID is the network address of the device. The network address of a device serves to distinguish itself on a DeviceNet fieldbus system from any other device or Slave on this network. This should be a unique number for each device. A valid MAC-ID address is within a range of 0 to 63 and can be re-entered and changed in the MAC-ID box in the Device Configuration Dialog.

Modbus Data Model

The data model distinguishes four basic types of data areas:

- Discrete Inputs (inputs) = FC 2 (Read)
- coils (outputs) = FC 1, 5, 15 (Write and Read back)
- Input register (input data) = FC 4 (Read)
- Holding register (output data) = FC 3, 6, 16, 23 (Write and Read back).

It should be noted, however, that depending on the device manufacturer and device type:

- the data area in the device may be present or not,
- and two data areas can be combined into one data region. For example, discrete inputs and input registers can be a common data area, which can be accessed with read-FC 2 and FC 4.
- Further FC 1 and FC 3 are used instead of reading back the inputs to read the outputs.

MPI

Multi Point Interface

The MPI is a proprietary interface of the SIMATIC® S7® series of PLCs. It is compatible to PROFIBUS and based on RS-485. It usually works with a transmission rate of 187.5 kBaud.

netX

networX on chip, Hilscher network communication controllers

netX Configuration Tool

The netX Configuration Tool allows users to operate cifX or netX based devices in different networks. Its graphical user interface serves as a configuration tool for the installation, configuration and diagnosis of the devices.

Object Dictionary

An object dictionary is a storage area for device parameter data structures. It is accessed in standardized manner.

Open Modbus/TCP

A communication system for Industrial Ethernet designed and developed by Schneider Automation and maintained by the Modbus-IDA organization based on the Modbus protocols for serial communication.

PCB

Printed Circuit Board, (printed = machine-made) circuit board

PCIe

Abbreviation for PCI Express

PC Card cifX

Communication Interfaces of the cifX product family of Hilscher on the basis of the communication controller netX 100:

for the Real-Time Ethernet systems

- EtherCAT
- EtherNet/IP
- Open-Modbus/TCP
- POWERLINK
- PROFINET IO
- sercos
- VARAN

and for the fieldbus systems

- PROFIBUS DP
- PROFIBUS MPI
- CANopen
- DeviceNet
- AS-Interface
- CompoNet
- CC-Link

as Communication Interface netX with PCI Bus

- PCI (CIFX 50),
- PCI Express (CIFX 50E),
- Low Profile PCI Express (CIFX 70E, CIFX 100EH-RE\CUBE*),
- Compact PCI (CIFX80),
- Mini PCI (CIFX90),
- Mini PCI Express (CIFX 90E),
- PCI-104 (CIFX 104C)

and as Communication Interface netX with ISA Bus

- PC/104 (CIFX 104).

*only Real-Time Ethernet

PROFINET

A communication system for Industrial Ethernet designed and developed by PROFIBUS & PROFINET International (PI). It uses some mechanisms similar to those of the PROFIBUS field bus.

PROFINET IO Controller

A PROFINET control unit responsible for the defined run-up of an I/O subsystem and the cyclic or acyclic data exchange.

PROFINET IO Device

A PROFINET field device that cyclically receives output data from its IO-Controller and responds with its input data.

RE

RE stands for Real-Time Ethernet

Real-Time Ethernet

Real-Time Ethernet (Industrial Ethernet) is an extension of the Ethernet networking technology for industrial purposes with very good real-time features and performance. There is a variety of different Real-Time Ethernet systems on the market which are incompatible with each other. The most important systems of these are

- EtherCAT

- EtherNet/IP
- Ethernet POWERLINK
- Open Modbus/TCP
- PROFINET
- sercos
- VARAN

Register

A register is a 16-bit wide storage area for data which can be accessed and addressed as a unit by some of the Modbus Function Codes.

Depending on the used Modbus function code a single register or multiple registers sequentially located can be accessed.

Modbus differs Input Registers (FC 4) and Holding Registers (FC 3, 6, 16, 23).

Remanent

Remanent memory holds its data even after power-off, for instance flash memory is remanent. It is also called non-volatile memory.

RJ45

A connector type often used for Ethernet connection. It has been standardized by the Federal Communications Commission of the USA (FCC).

sercos

A communication system for industrial Ethernet designed and developed by Bosch-Rexroth and supported by sercos International.

Switch

A network component connecting multiple communication partners (or even entire branches of a network) with each other. A switch is an intelligent network component which analyzes network traffic in order to decide on its own. For the connected communication partners a switch behaves transparently.

SYCON.net

FDT/DTM based configuration and diagnosis software by Hilscher

SYNC

Synchronization cycle of the master

TCP/IP

Transport Control Protocol/Internet Protocol connection-orientated, secure transfer protocol as basis for the Internet-protocols

UCMM

Unconnected Message Manager

VARAN**Versatile Automation Random Access Network**

A communication system for industrial Ethernet based on the DIAS-BUS developed by Sigmatek. The system is supported by the VARAN-BUS-NUTZERORGANISATION (VNO).

Watchdog Timer

A watchdog timer provides an internal supervision mechanism of a communication system. It supervises that an important event happens within a given timeframe (the watchdog time which can be adjusted accordingly, for instance by a parameter in the warmstart message) and causes an alarm otherwise (usually this is accomplished by changing the operational state of the communication system to a more safe state).

X1, X2, X3, X4 ...

serve as position names on the circuit board but can also have other or extended meanings

X1, X2

(names on the front panel) ... serve for PC cards cifX PCI and PCI Express with 2 channels to identify the respective communication channel:
X1 stands for fieldbus 1 (channel X1; in SYCON.net assigned to *Ch0*).
X2 stands for fieldbus 2 (channel X2; in SYCON.net assigned to *Ch1*).

XDD file

A special kind of Device Description file used by Ethernet POWERLINK.

XML

XML means Extended Markup Language. It is a symbolic language for structuring data systematically. XML is standard maintained by the W3C (World-wide web consortium). Device Description Files often use XML-based formats for storing the device-related data appropriately.

11.12 Contacts

Headquarters

Germany

Hilscher Gesellschaft für
Systemautomation mbH
Rheinstrasse 15
65795 Hattersheim
Phone: +49 (0) 6190 9907-0
Fax: +49 (0) 6190 9907-50
E-Mail: info@hilscher.com

Support

Phone: +49 (0) 6190 9907-99
E-Mail: de.support@hilscher.com

Subsidiaries

China

Hilscher Systemautomation (Shanghai) Co. Ltd.
200010 Shanghai
Phone: +86 (0) 21-6355-5161
E-Mail: info@hilscher.cn

Support

Phone: +86 (0) 21-6355-5161
E-Mail: cn.support@hilscher.com

France

Hilscher France S.a.r.l.
69500 Bron
Phone: +33 (0) 4 72 37 98 40
E-Mail: info@hilscher.fr

Support

Phone: +33 (0) 4 72 37 98 40
E-Mail: fr.support@hilscher.com

India

Hilscher India Pvt. Ltd.
New Delhi - 110 065
Phone: +91 11 26915430
E-Mail: info@hilscher.in

Italy

Hilscher Italia S.r.l.
20090 Vimodrone (MI)
Phone: +39 02 25007068
E-Mail: info@hilscher.it

Support

Phone: +39 02 25007068
E-Mail: it.support@hilscher.com

Japan

Hilscher Japan KK
Tokyo, 160-0022
Phone: +81 (0) 3-5362-0521
E-Mail: info@hilscher.jp

Support

Phone: +81 (0) 3-5362-0521
E-Mail: jp.support@hilscher.com

Korea

Hilscher Korea Inc.
Seongnam, Gyeonggi, 463-400
Phone: +82 (0) 31-789-3715
E-Mail: info@hilscher.kr

Switzerland

Hilscher Swiss GmbH
4500 Solothurn
Phone: +41 (0) 32 623 6633
E-Mail: info@hilscher.ch

Support

Phone: +49 (0) 6190 9907-99
E-Mail: ch.support@hilscher.com

USA

Hilscher North America, Inc.
Lisle, IL 60532
Phone: +1 630-505-5301
E-Mail: info@hilscher.us

Support

Phone: +1 630-505-5301
E-Mail: us.support@hilscher.com