

WPD FS

Flow Sensor
for hot water up to 130 °C
DN 40 ... DN 300



Main characteristics

Patented hydrodynamically balanced rotor
Patented symmetrical calibration adjustment
Hermetically sealed register (IP 68)
Register may be rotated through 360°
High overload capability
Removable measuring element
Up to 3 pulsers (1 x OD, 2 x RD) may be fitted without breaking the approval seal
Powder coating ensures maximum corrosion protection

Application

Flow sensor for heat meters for commercial and light industrial use
DN 50 bis 150 for customer billing
For measurement of hot process water up to 130 °C
For high permanent flow rates such as generated by pumps, as well as for the measurement of low flow rates in off-peak periods
Installation in horizontal and vertical pipe lines

Conformity marking

DN 50 ... 150:
DE-17-MI004-PTB002
CE M-XX* 0102

* Year of production

Installation

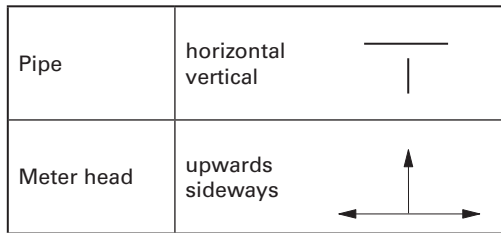

Installation Requirements

- Unrestricted straight pipe upstream of the meter 3 x DN
- No abrupt restrictions directly behind the meter

Technical Data

Performance data WPD FS 130 °C

Nominal Diamter		DN	40	50	65	80	100	125	150	200	250	300
Q_{max}	Maximum Peak Flow once lifetime 24 h Q_{max} or 5 min. $1.2 \times Q_{max}$	m ³ /h	20	30	60	90	140	200	300	500	1000	1200
Q_n	Continuous Flow	m ³ /h	10	15	25	45	70	100	150	250	500	600
Q_t	Transitional Flow	m ³ /h	1.8	1.8	2.0	3.2	4.8	8.0	12	20	45	50
Q_{min}	Minimum Flow	m ³ /h	0.6	0.6	1.0	1.4	2.0	3.5	4.5	8	20	25
	Staring Flow	m ³ /h	0.25	0.25	0.3	0.35	0.6	1.1	1.7	2.0	10	15

Performance data table according to DIN EN 1434

Nominal Diamter		DN	50	65	80	100	125	150
q_s	Overload Flowrate	m ³ /h	30	50	80	120	200	300
q_p	Continuous Flow horizontal	m ³ /h	15	25	40	60	100	150
q_{ih}	Minimum Flow horizontal	m ³ /h	0.6	1	1.6	2.4	4	6
q_{iv}	Minimum Flow vertical	m ³ /h	1.5	2.5	4	6	10	15
q_p / q_i	Ratio horizontal		25	25	25	25	25	25
q_p / q_i	Ratio vertical		10	10	10	10	10	10

Typical Accuracy Curve

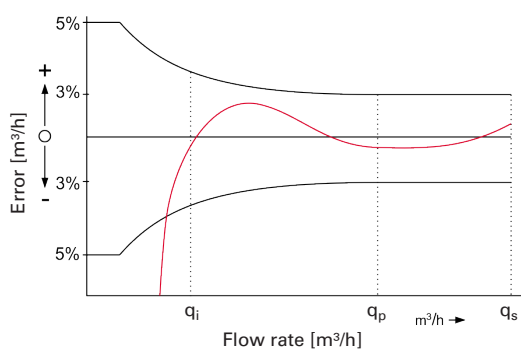

- q_s = maximum peak flow
- q_p = continuous flow $\pm 2\%$
- q_i = minimum flow $\pm 5\%$

Typical Head Loss Curve

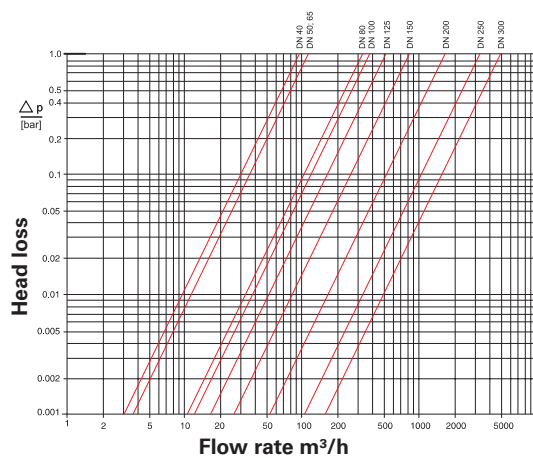

Dimensions and Weights

Nominal Diameter		DN	40	50	50	65	65	80	80	100	100	125	150	150	200	250	300	
Dimensions	overall length L *)	mm	220	200	270	200	300	225	300	250	360	250	300	500	350	450	500	
	height	H	mm	120	120	120	120	120	150	150	150	150	160	177	177	206	231	256
		h	mm	69	73	73	85	85	95	95	105	105	118	135	135	162	194	226
		g	mm	200	200	200	200	200	270	270	270	270	280	356	356	441	466	491
Weights	meter	kg	7.4	7.7	9.5	10.0	11.9	14.0	16.1	18.0	20.0	20.5	35.5	43.8	50.5	72.3	99.3	
	measuring element	kg	1.4	1.4	1.4	1.4	1.4	3.0	3.0	3.0	3.0	3.0	5.5	5.5	7.5	7.5	7.5	
	body	kg	6.0	6.3	8.1	8.6	10.5	11.0	13.1	15.0	17.0	17.5	30.0	38.3	43.0	71.3	91.8	

*) Other overall lengths on request

Dimension Picture

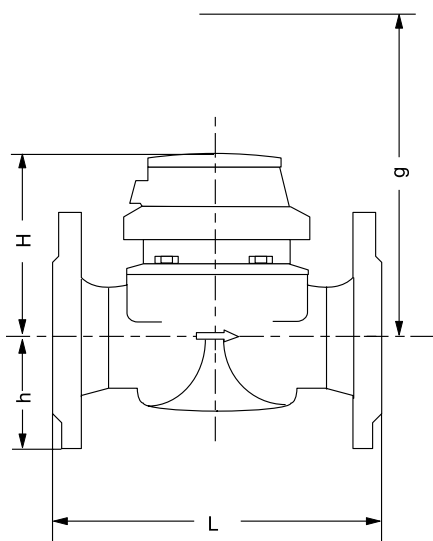

Materials

Body	cast iron
Measuring element	plastic
Rotor	plastic
We also use the following materials	brass stainless steel

Environmental Conditions

Electromagnetic environment	Class E2
Mechanical environment condition	Class M1
Protection class acc. to DIN EN 60529	IP 68
Temperature range	10 ... 130 °C

Dials

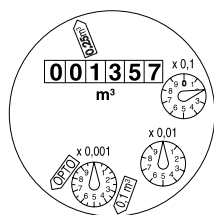

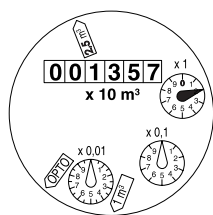

DN 40 ... DN 125



DN 150 ... DN 300

Nominal Diameter DN	Smallest reading m³	Max. reading m³
40 ... 125	0.0005	1 000 000
150 ... 300	0.005	10 000 000

Pulse Values

Pulser		Pulse value	
		DN 50 ... DN 100	DN 150 ... DN 300
RD02 / RD022		0.25 and 0.1 m ³ or 0.25 and 0.025 m ³	1 and 2.5 m ³ or 2.5 and 0.25 m ³
OD 02		0.001 m ³	0.01 m ³
OD 04		0.01 m ³	0.1 m ³

Available Design

Nominal Diameter	DN	40	50	65	80	100
Overall Length	mm	220	200	200	225	250
Overall Length	mm	---	270	300	300	360

Nominal Diameter	DN	125	150	200	250	300
Overall Length	mm	250	300	350	450	500
Overall Length	mm	---	500	---	---	---

Order Example

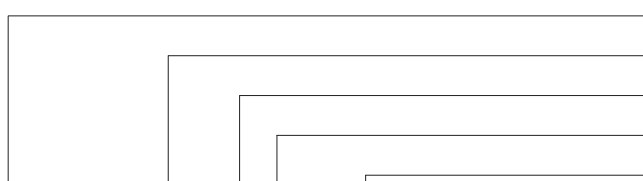
	Type
	Nominal Diameter
	Temperature
	Pressure rate
	Overall length
WPD FS, DN 50, 130/16, L = 200 mm, 0,25/0.1 m ³	Pulse values
drilled acc. to EN 1092 PN 16	Flange drilling



qualityaustria Certified according to ISO 9001
Succeed with Quality Quality Management System Quality Austria Reg.no. 3496/0

UK & Ireland Enquiries

Sensus UK Systems Ltd, 3 Lindenwood Crockford Lane, Chineham Business Park
Basingstoke RG24 8QY UK
T: +44 (0) 1256 372800 F: +44 (0) 1256 707203 Email: info.gb@xylem.com www.sensus.com

International Enquiries

Sensus GmbH Hannover, Meineckestraße 10, D-30880 Laatzen Germany
T: +49 (0) 5102 74-0 F: +49 (0) 5102 74-3341 Email: info.int@xylem.com www.sensus.com